

DENSO NEC76F0085 275036-7400 TOYOTA

plugin **940**

WARNING : for a correct identification of the ECU it is necessary to open the ECU and always check that the ECU numbers printed on the motherboard are the same as the numbers declared on the manual. Do not trust the numbers on the ECU cover.

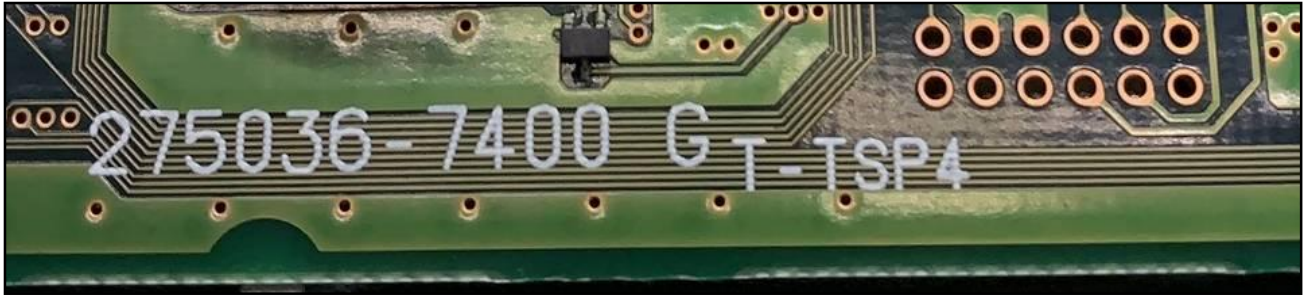

DENSO NEC76F0085 275036-7400 TOYOTA

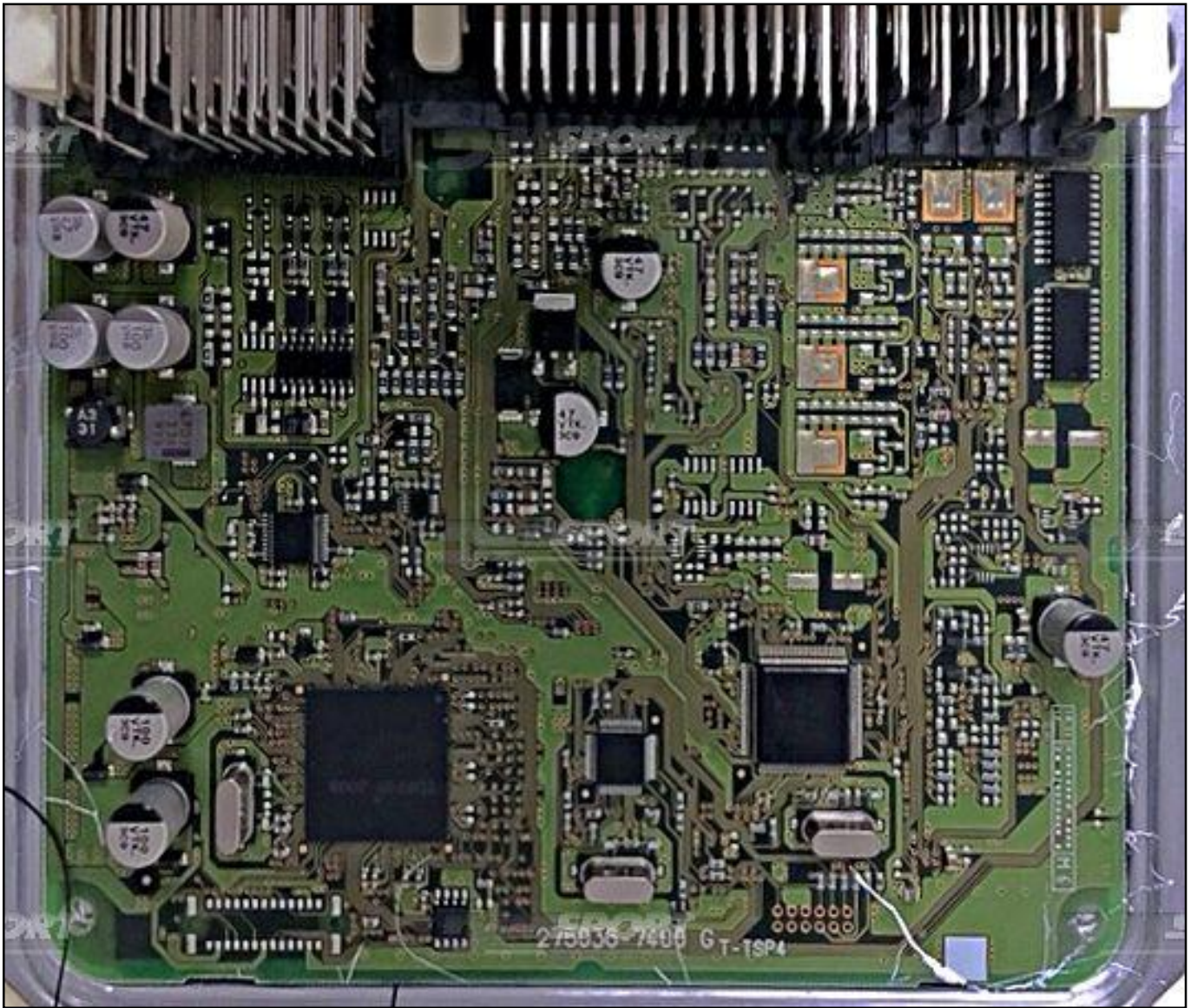

DENSO NEC76F0085 275036-7400 TOYOTA

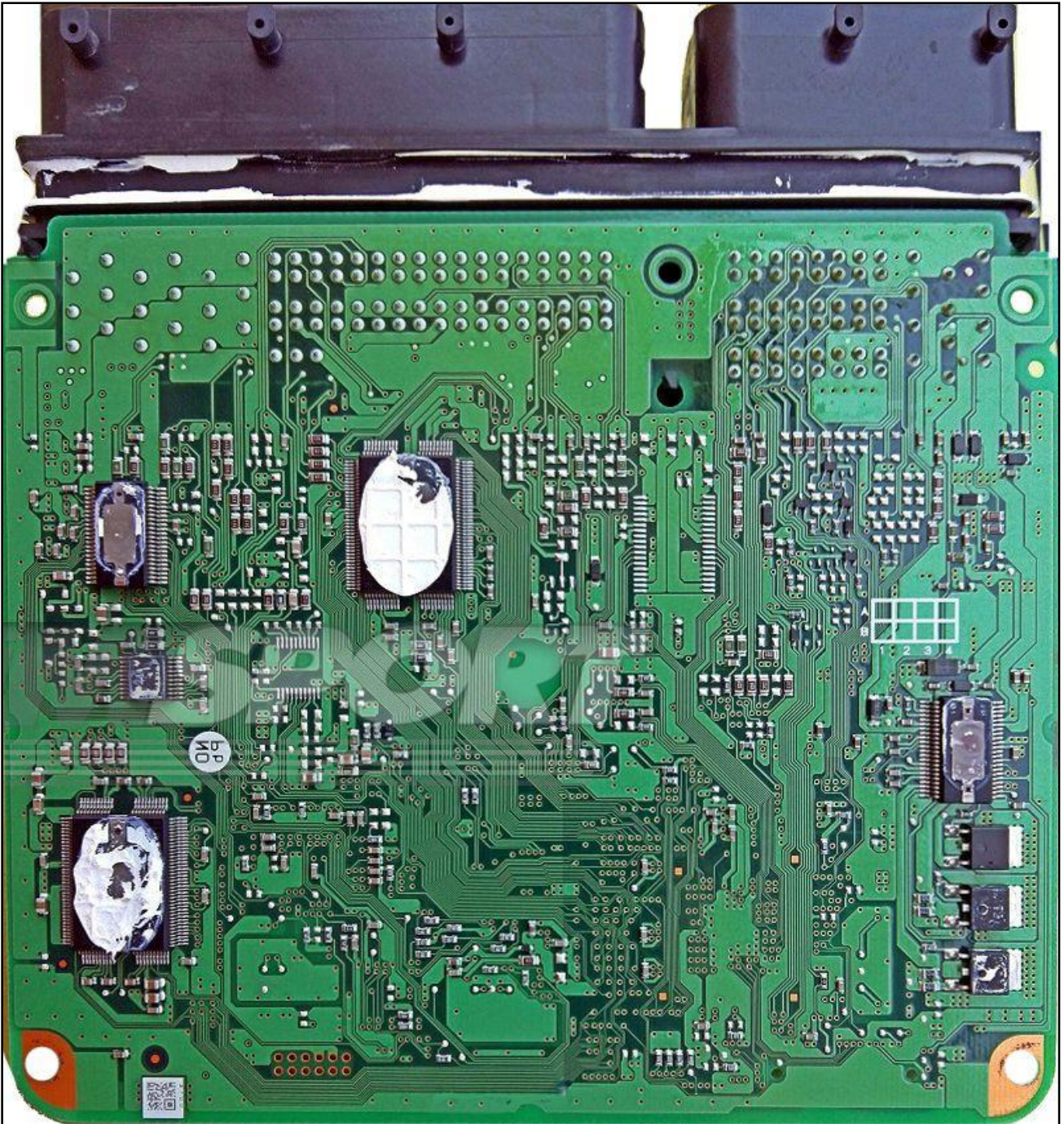

DENSO NEC76F0085 275036-7400 TOYOTA

DIRECT CONNECTION

For the connection use the cable F32GN037C connected to the ECU.

Make sure that the POWER led (red) on Trasdata is ON.

These connections are required for all the connection approaches: loose wires, soldering adapter, metal positioning frame adapter.

COLORE FILO WIRE COLOUR	DESCRIZIONE DESCRIPTION
ROSSO RED	POSITIVO DIRETTO POWER BATTERY
ARANCIO ORANGE	POSITIVO SOTTO QUADRO POWER SWITCH ON
NERO BLACK	MASSA GND
GIALLO YELLOW	KLINE
VERDE GREEN	CAN LOW
BIANCO WHITE	CAN HIGH
GRIGIO GREY	POL4 BOOT
BLU BLUE	POL5 CNF1
VIOLA/GRIGIO PURPLE/GREY	TENSIONE PROG. PROG. VOLTAGE
MARRONE BROWN	RESET

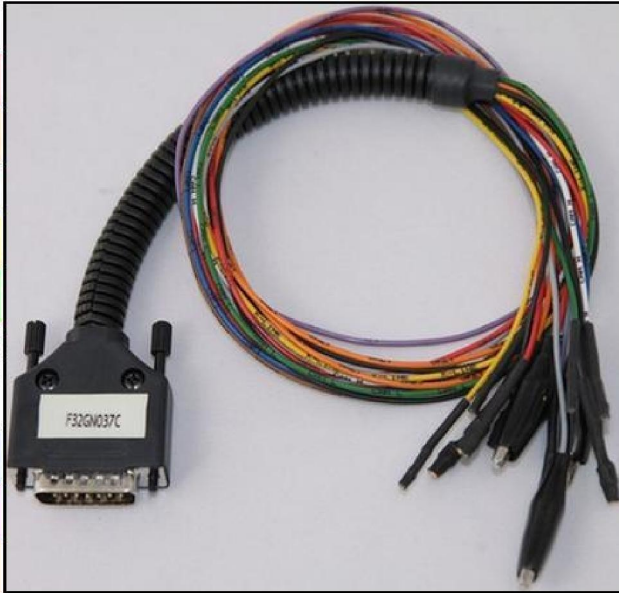

ECU CONNECTOR TYPE 01



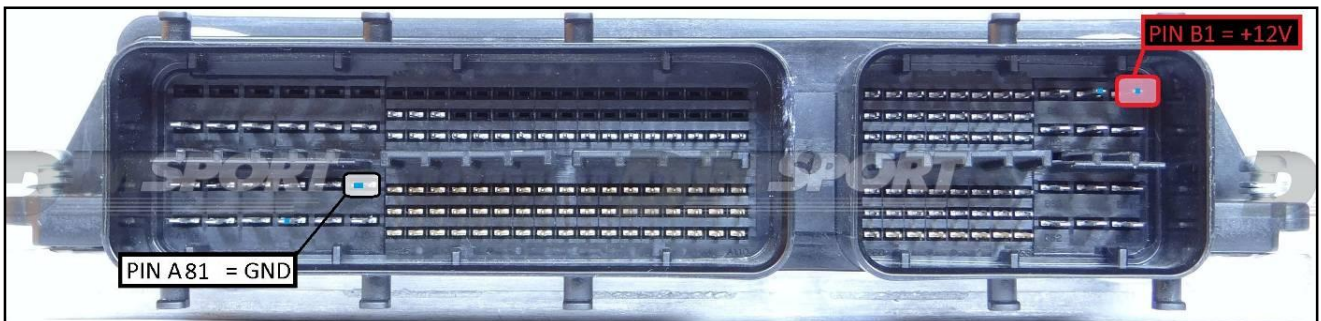

ECU CONNECTOR TYPE 02



DENSO NEC76F0085 275036-7400 TOYOTA

LOOSE WIRES CONNECTION:

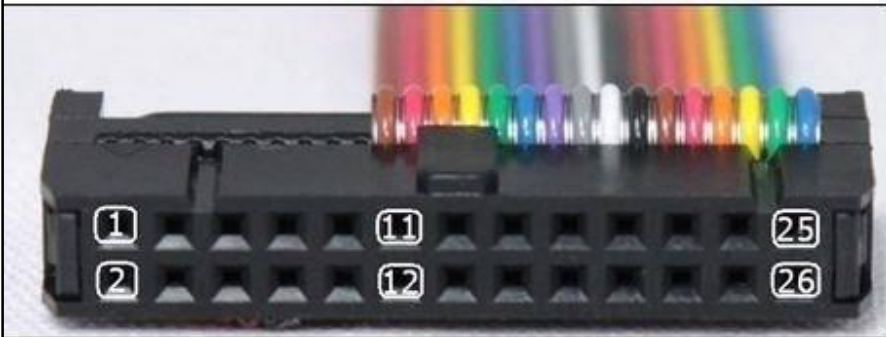
For the READING and WRITING procedure use the FLAT cable F34NTF53

Pin	Colore Colour
11	Non usato Not used
12	Non usato Not used
13	Non usato Not used
14	Non usato Not used
15	Verde Green
16	Blu Blue
17	Viola Violet
18	Grigio Grey
19	Bianco White
20	Nero Black
21	Marrone Brown
22	Rosso Red
23	Arancio Orange
24	Giallo Yellow
25	Verde Green
26	Non usato Not used

DENSO NEC76F0085 275036-7400 TOYOTA

WARNING : the grey wire 18 must be connected to the pad placed on the backside of the board, as shown in the following picture.

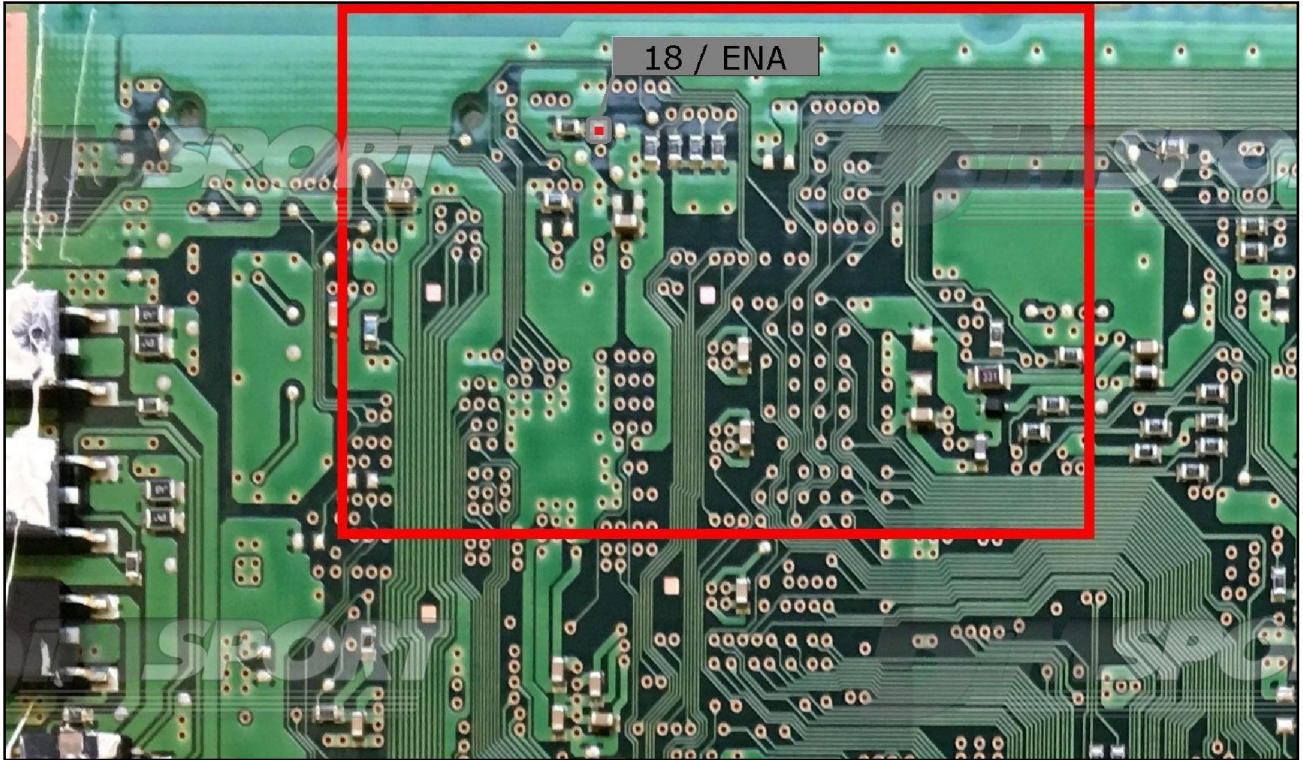

DENSO NEC76F0085 275036-7400 TOYOTA

WARNING: for a correct reading and writing operation it is necessary to perform a LINK between the pads displayed in the picture here below. Remove the LINK before placing back the ECU into the car.

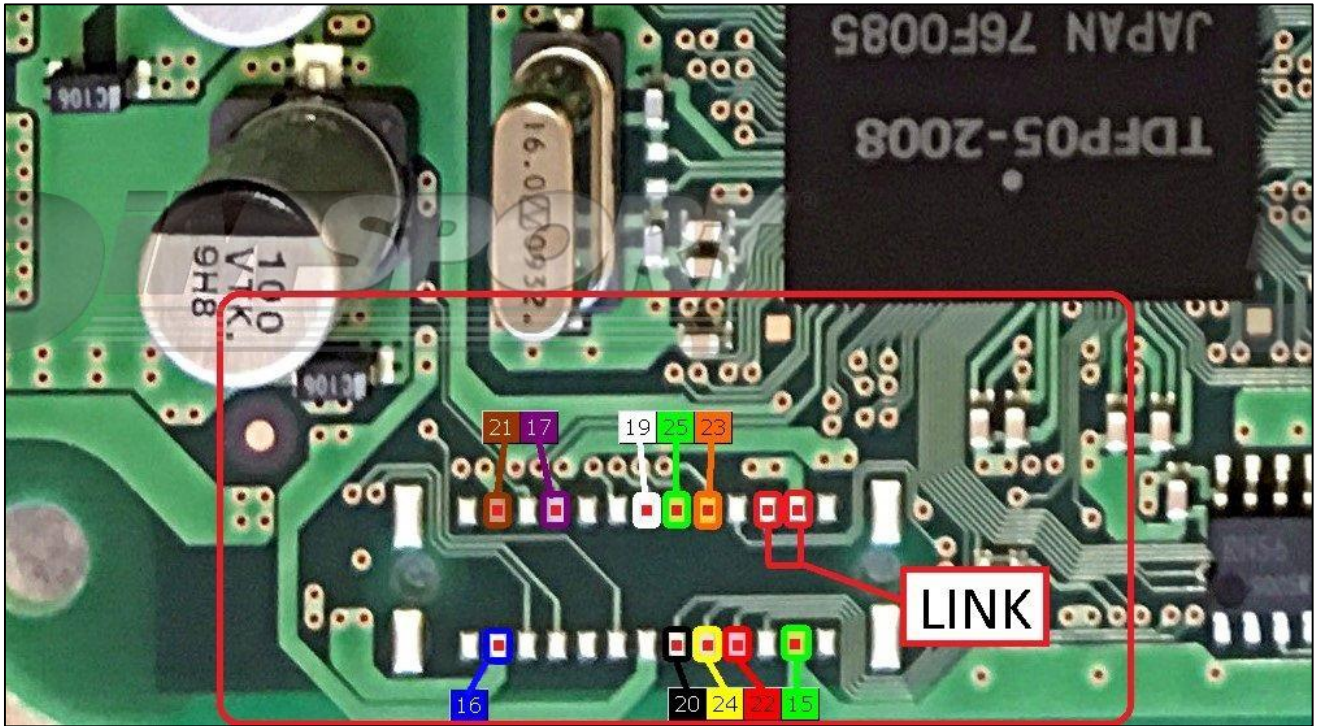

DENSO NEC76F0085 275036-7400 TOYOTA

**F34NTA17 Soldering adapter connection or
F34DM024 metal positioning frame adapter connection.**

In both cases, for a correct connection, it is necessary to identify the pin 1 for the reading&writing procedures and the pin 18.

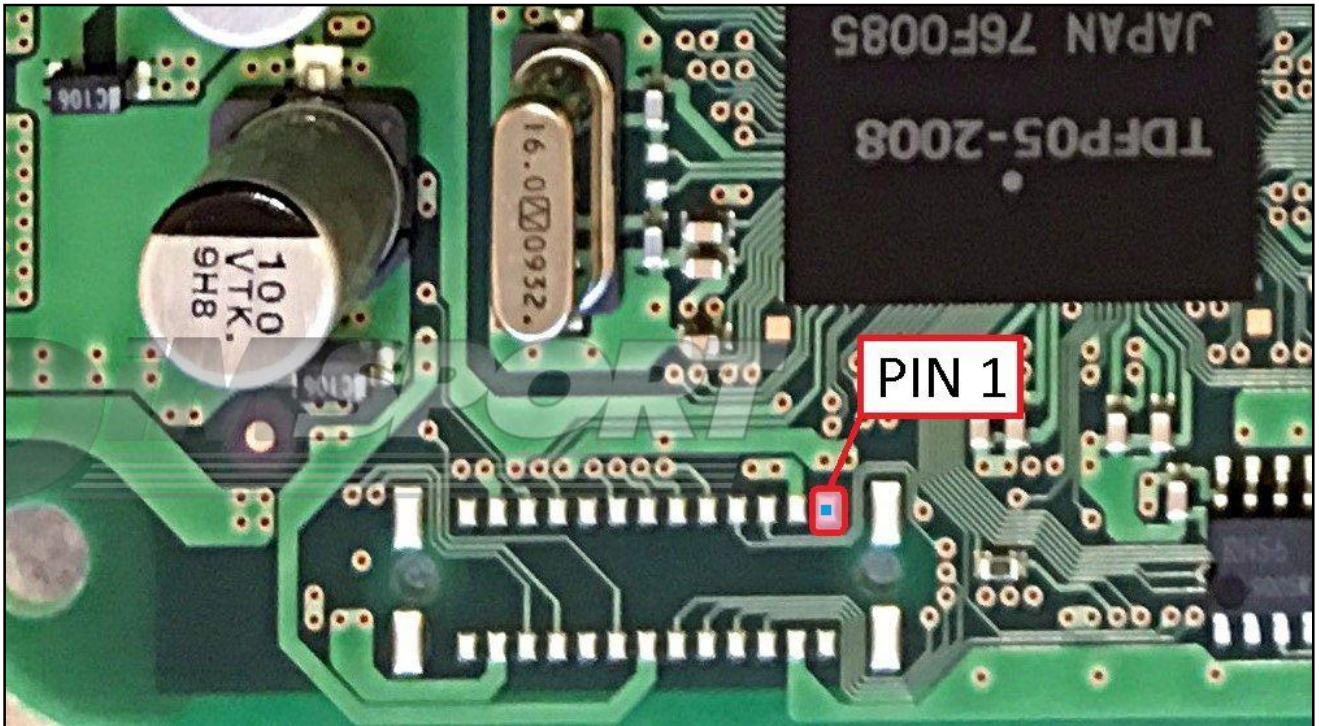

Identify the pin 18, placed on the backside of the board, as shown in the following picture to enable the Microprocessor communication.

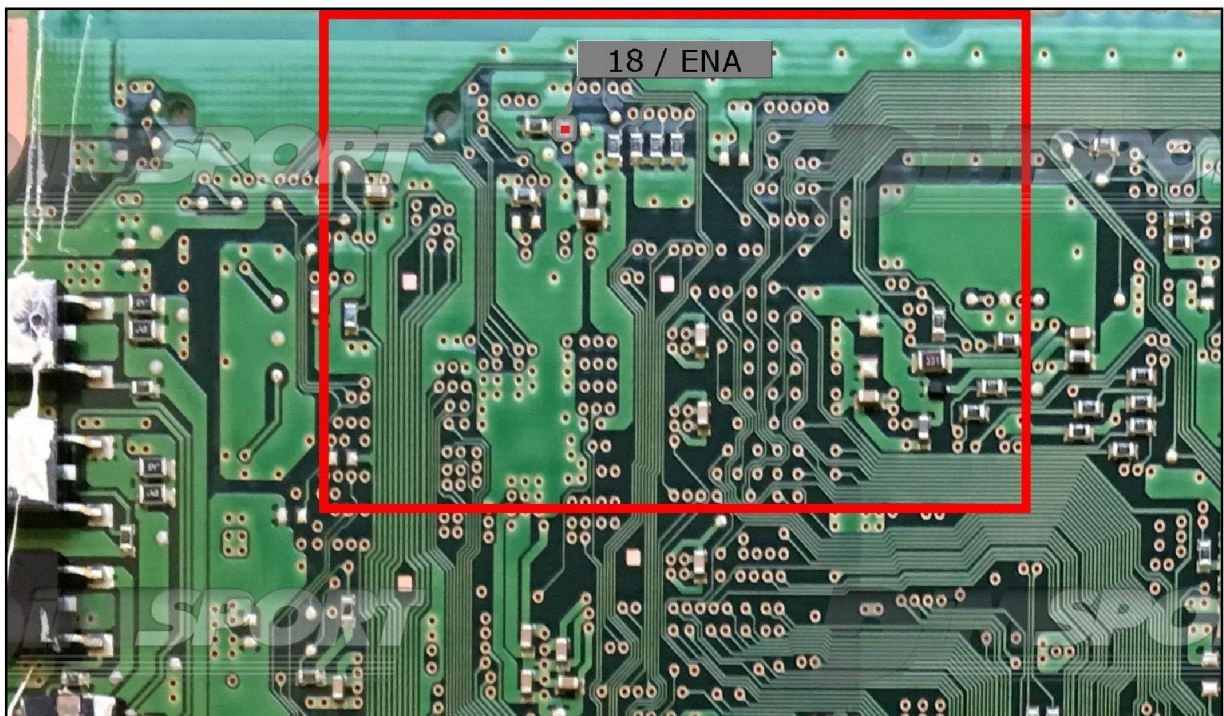

DENSO NEC76F0085 275036-7400 TOYOTA

F34NTA17 Soldering adapter connection



By using the grey wire supplied with the adapter connect the pad 18 (see pg.8) to the specific connector on the adapter itself.
The following picture of the F34NTA17 adapter connection is merely indicative.

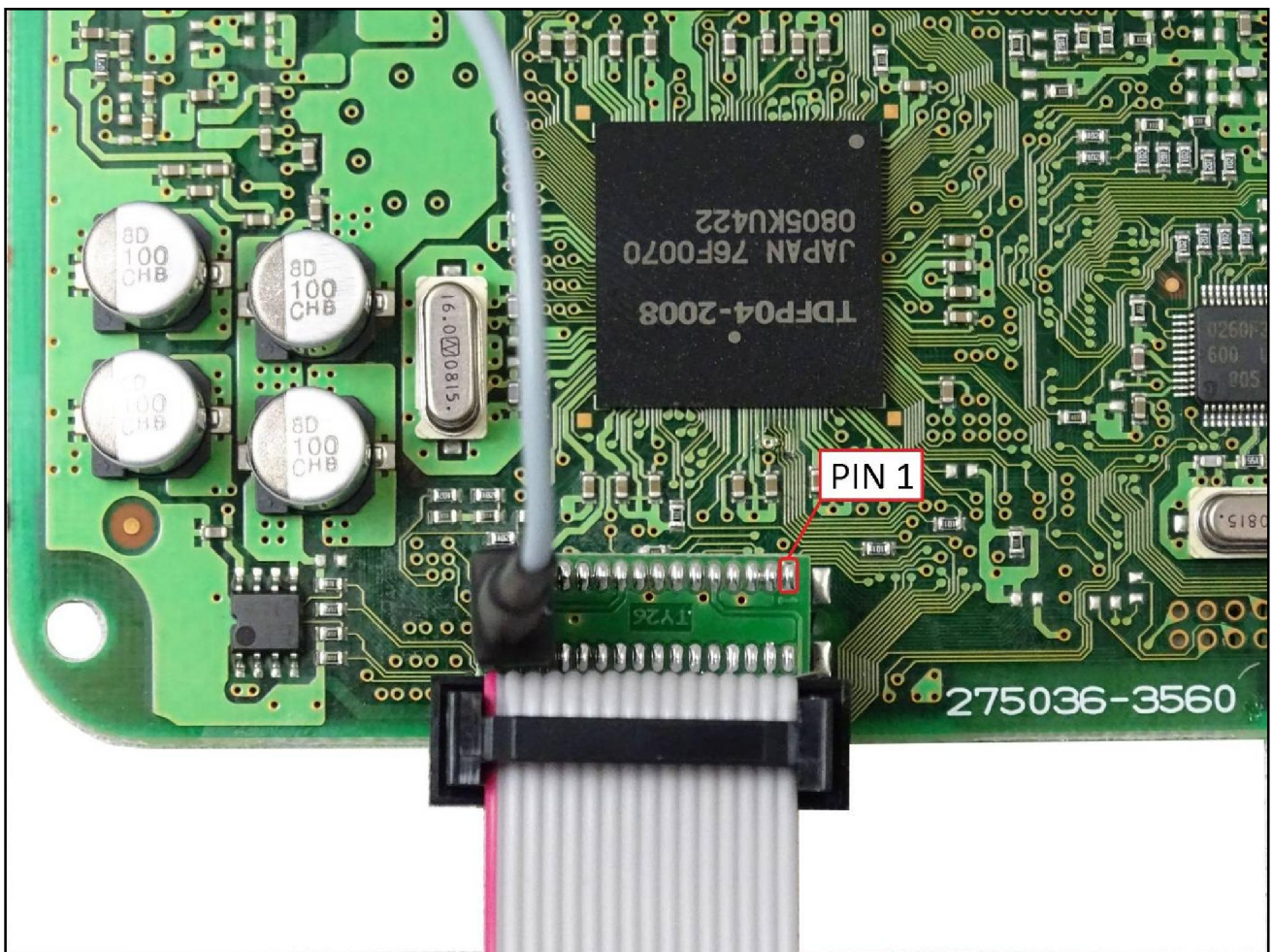

DENSO NEC76F0085 275036-7400 TOYOTA

F34DM024 metal positioning frame adapter connection

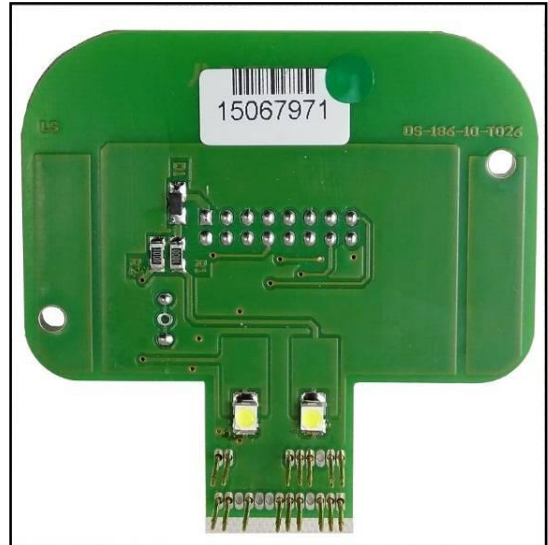
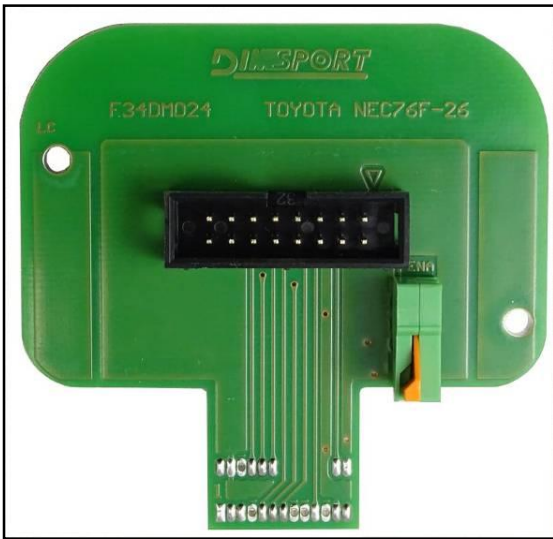

By using a wire connect the pad 18 (see pg.8) to the specific orange clamp ENA present on the F34DM024 DIMA adapter.
The following picture of the F34DM024 DIMA adapter connection is merely indicative.

