

# PCMtuner module 42

Denso SH705x Bootloader

by PCMtuner Marty

## Contents/

Contents/ .....	2
DIESEL CARS: MAZDA, MITSUBISHI, NISSAN, SUBARU SH705x .....	3
OPEL 1.7L CDTI SH7058/SH7059 .....	4
OPEL 1.7L HYBRID SH7055 .....	5
DIESEL TRUCKS SH7055/SH7058 .....	6
DIESEL TRUCKS SH7058 .....	7
ISUZU NPR (NQR) 5.2L DIESEL SH7058/SH7059 .....	8
MAZDA PETROL SH7055/SH7058 .....	9
SUBARU 22611-AG57X SH7055 .....	10
SUBARU METAL CASE SH7055/SH7058 .....	11
SUBARU PLASTIC CASE SH7058(S) .....	12
SUBARU STELLA 2008 SH7058S .....	13
SUBARU TCU SH7055/SH7058 .....	14
SUZUKI JIMNY, LIANA SH7055 .....	15
SUZUKI SH7055/SH7058 .....	16
VOLVO 2.4L SH7058 .....	17
JAGUAR X 2001-2008, S/XJ/XK 2003-2006 SH7055 .....	18

# PCMtuner

Engine Control Unit

## SH705x

### T1 SH7055, SH7058

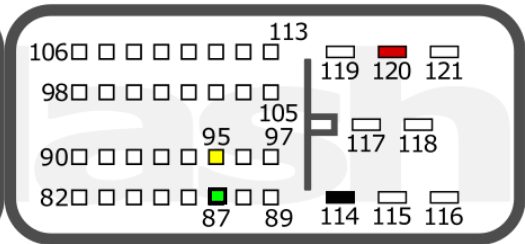

<b>+12V</b>	T2: 120	<b>CAN-L</b>	T2: 87
<b>GND</b>	T2: 114	<b>CAN-H</b>	T2: 95

### SH7058, SH7059

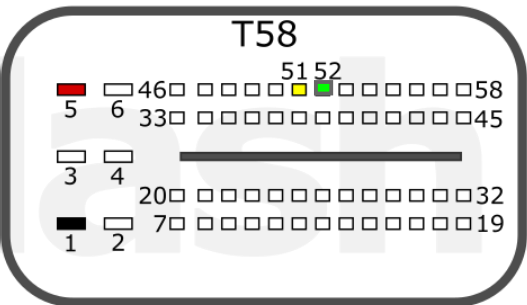

<b>+12V</b>	T58: 5	<b>CAN-L</b>	T58: 52
<b>GND</b>	T58: 1	<b>CAN-H</b>	T58: 51

### DIESEL CARS

MAZDA

MITSUBISHI

NISSAN

SUBARU

[www.iecutool.com](http://www.iecutool.com)

v.1

2022-06-06

PCMtuner

Engine Control Unit

SH7058/SH7059

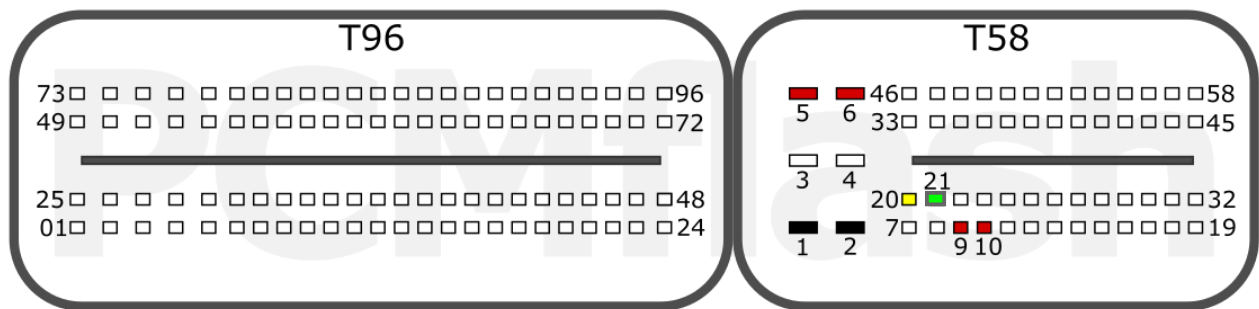

<b>+12V</b>	T58: 5, 6, 9, 10	<b>CAN-L</b>	T58: 21
<b>GND</b>	T58: 1, 2	<b>CAN-H</b>	T58: 20

OPEL 1.7L CDTI

[www.iecutool.com](http://www.iecutool.com)

v.1

2022-06-06

PCMtuner

Engine Control Unit

SH7055

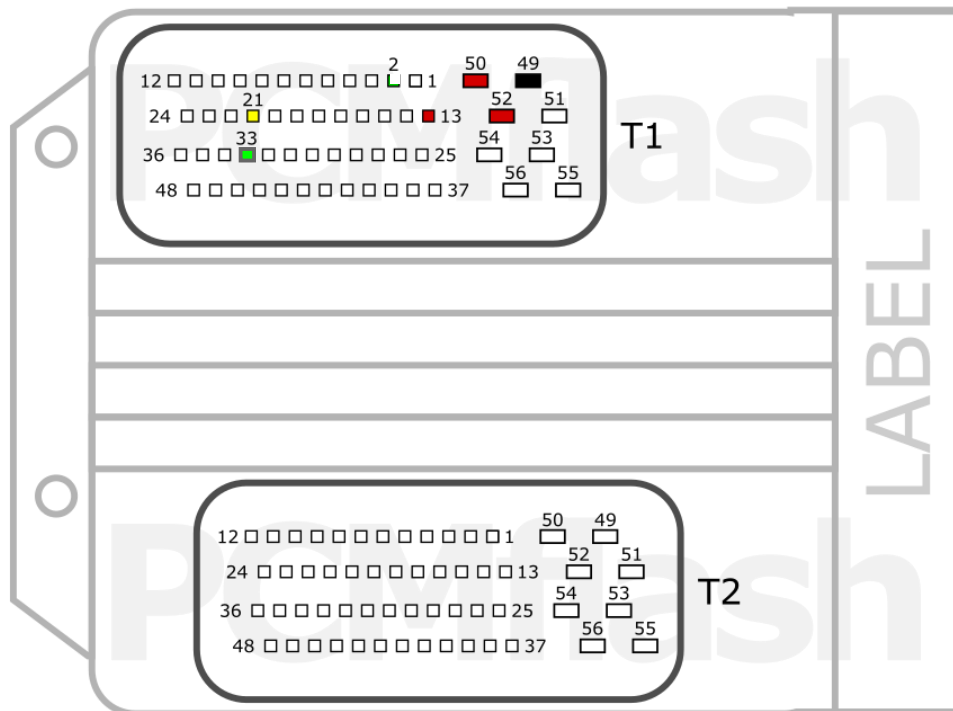

<b>+12V</b>	T1: 13, 50, 52	<b>CAN-L</b>	T1: 33
<b>GND</b>	T1: 49	<b>CAN-H</b>	T1: 21
	T1: 2 (Not used)		

OPEL 1.7L HYBRID

[www.iecutool.com](http://www.iecutool.com)

v.1

2022-06-06

PCMtuner

Engine Control Unit

SH7055/SH7058

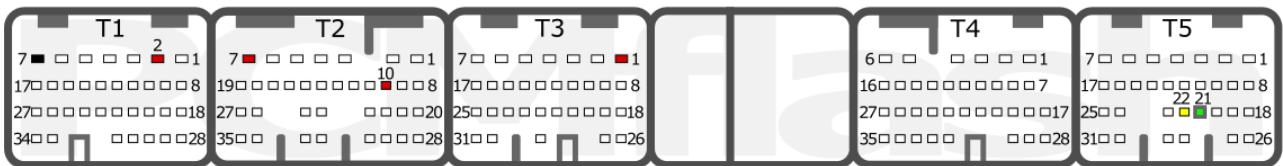

<b>+12V</b>	T1: 2; T2: 7, 10; T3: 1	<b>CAN-L</b>	T5: 21
<b>GND</b>	T1: 7	<b>CAN-H</b>	T5: 22

DIESEL TRUCKS

[www.iecutool.com](http://www.iecutool.com)

v.1

2022-06-06

PCMtuner

Engine Control Unit

SH7058

LABEL

T1

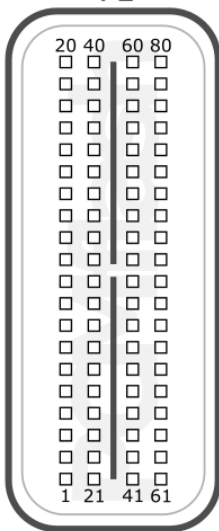

T2

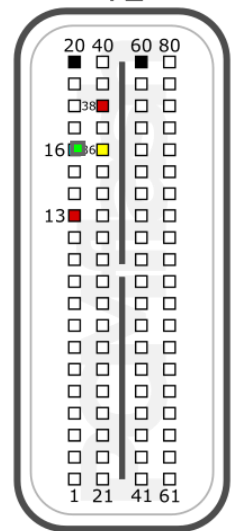

<b>+12V</b>	T2: 13, 38	<b>CAN-L</b>	T2: 16
<b>GND</b>	T2: 20, 60	<b>CAN-H</b>	T2: 36

DIESEL TRUCKS

[www.iecutool.com](http://www.iecutool.com)

v.1

2022-06-06

PCMtuner

Engine Control Unit

SH7058/SH7059

A

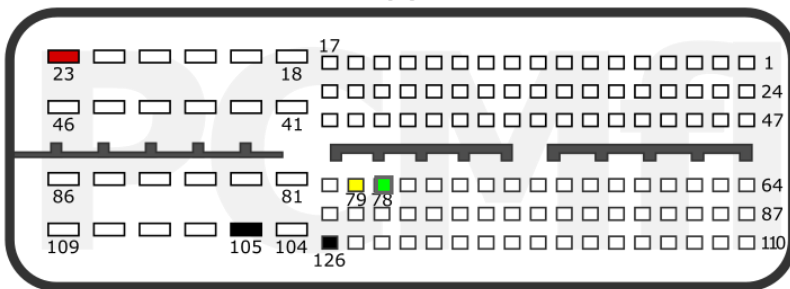

B

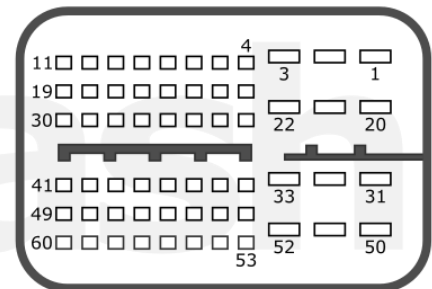

<b>+12V</b>	A: 23	<b>CAN-L</b>	A: 78
<b>GND</b>	A: 105, 126	<b>CAN-H</b>	A: 79

ISUZU NPR (NQR) 5.2L DIESEL

[www.iecutool.com](http://www.iecutool.com)

v.1

2022-06-07



PCMtuner

Engine Control Unit

SH7055/SH7058

MAZDA 2 (DE) ZY

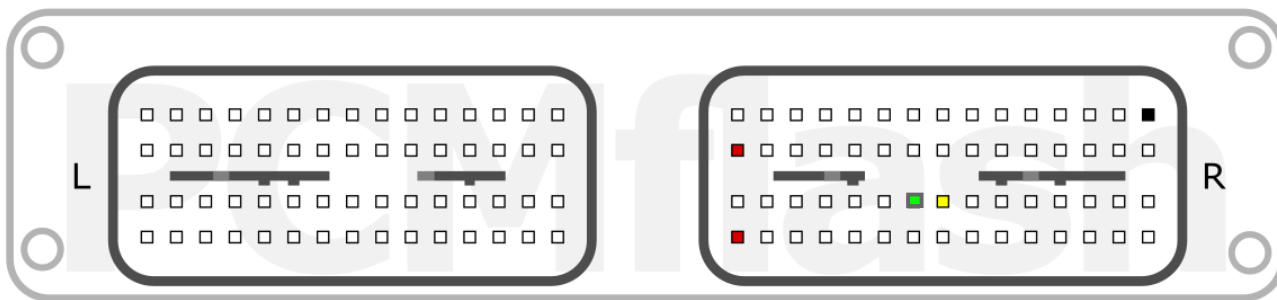

<b>+12V</b>	RED	<b>CAN-L</b>	GREEN
<b>GND</b>	BLACK	<b>CAN-H</b>	YELLOW

MAZDA 3 (BK) Z6

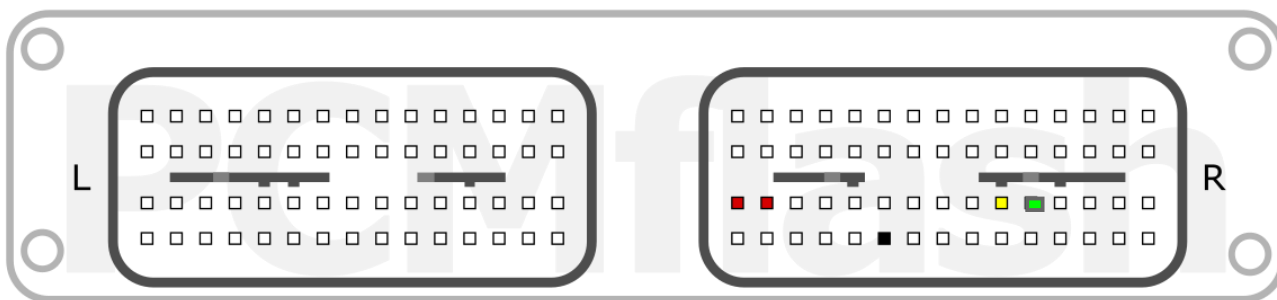

<b>+12V</b>	RED	<b>CAN-L</b>	GREEN
<b>GND</b>	BLACK	<b>CAN-H</b>	YELLOW

MAZDA PETROL

[www.iecutool.com](http://www.iecutool.com)

v.1

2022-06-08

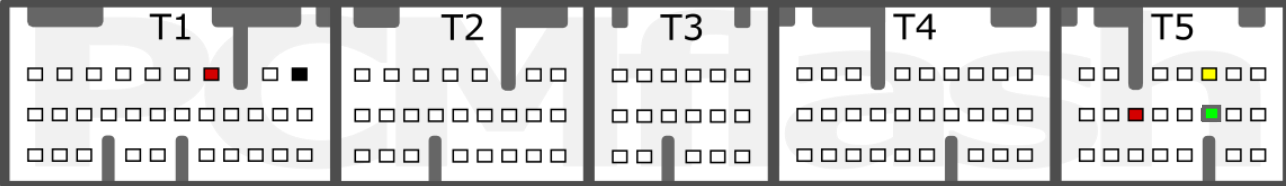
PCMtuner		Engine Control Unit									
		SH7055									
											
<table border="1"> <tr><td style="background-color: red; color: white; text-align: center;"><b>+12V</b></td></tr> <tr><td style="background-color: black; color: white; text-align: center;"><b>GND</b></td></tr> </table>		<b>+12V</b>	<b>GND</b>	<table border="1"> <tr><td style="text-align: center;">RED</td></tr> <tr><td style="text-align: center;">BLACK</td></tr> </table>		RED	BLACK	<table border="1"> <tr><td style="background-color: green; color: white; text-align: center;"><b>CAN-L</b></td></tr> <tr><td style="background-color: yellow; color: black; text-align: center;"><b>CAN-H</b></td></tr> </table>		<b>CAN-L</b>	<b>CAN-H</b>
<b>+12V</b>											
<b>GND</b>											
RED											
BLACK											
<b>CAN-L</b>											
<b>CAN-H</b>											
		<table border="1"> <tr><td style="text-align: center;">GREEN</td></tr> <tr><td style="text-align: center;">YELLOW</td></tr> </table>		GREEN	YELLOW						
GREEN											
YELLOW											
SUBARU 22611-AG57X											
<a href="http://www.iecutool.com">www.iecutool.com</a>		v.1	2022-01-27								

PCMtuner

Engine Control Unit

SH7055/SH7058

EJ (2.0T, 2.5L, 2.5T, 3.0L, 3.6L) immo\*

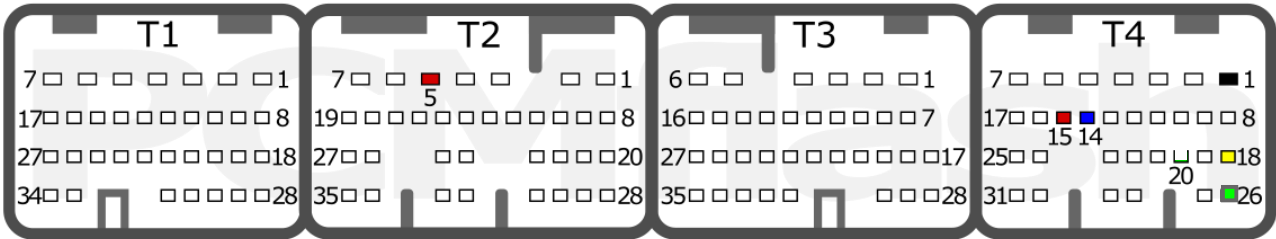

<b>+12V</b>	T2: 5; T4: 15	<b>CAN-L</b>	T4: 26
<b>GND</b>	T4: 1	<b>CAN-H</b>	T4: 18
	T4: 20 (Not used)	<b>TEST</b>	T4: 14 (Not used)
* ..... , cars with immo			

EJ (2.0T, 2.5L, 2.5T, 3.0L, 3.6L) w/o immo\*

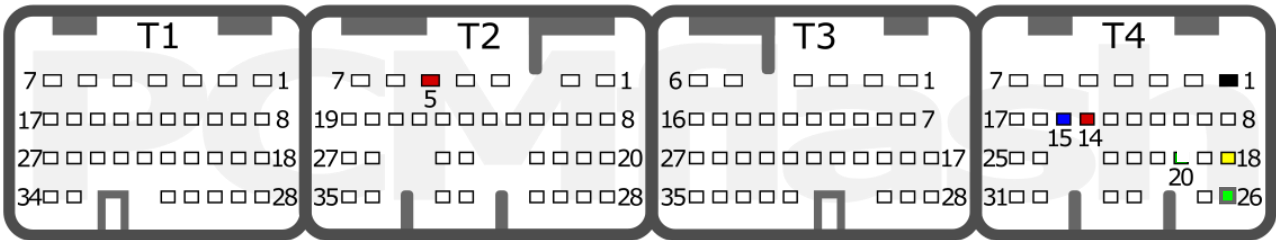

<b>+12V</b>	T2: 5; T4: 14	<b>CAN-L</b>	T4: 26
<b>GND</b>	T4: 1	<b>CAN-H</b>	T4: 18
	T4: 20 (Not used)	<b>TEST</b>	T4: 15 (Not used)
* ..... / cars without immo			

SUBARU METAL CASE

[www.iecutool.com](http://www.iecutool.com)

v.1

2022-06-06

<h1>PCMtuner</h1>	Engine Control Unit <h1>SH7058(S)</h1>
-------------------	---

## EJ (2.0T, 2.5L, 2.5T, 3.0L, 3.6L) immo

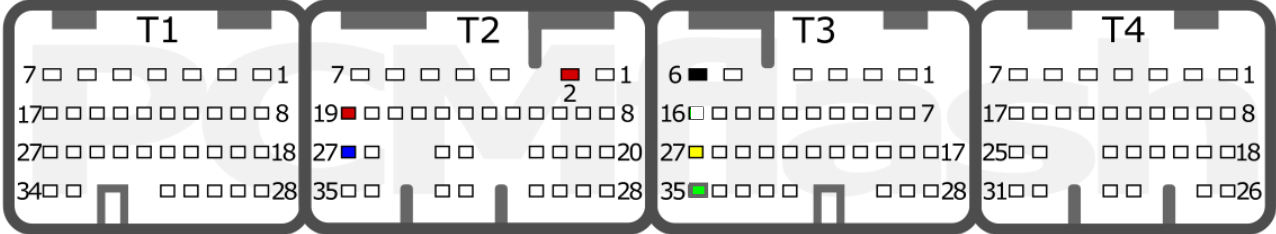

<b>+12V</b>	T2: 2, 19	<b>CAN-L</b>	T3: 35
<b>GND</b>	T3: 6	<b>CAN-H</b>	T3: 27
	T3: 16 (Not used)	<b>TEST</b>	T2: 27 (Not used)
* / cars with immo			

## EJ (2.0T, 2.5L, 2.5T, 3.0L, 3.6L) w/o immo

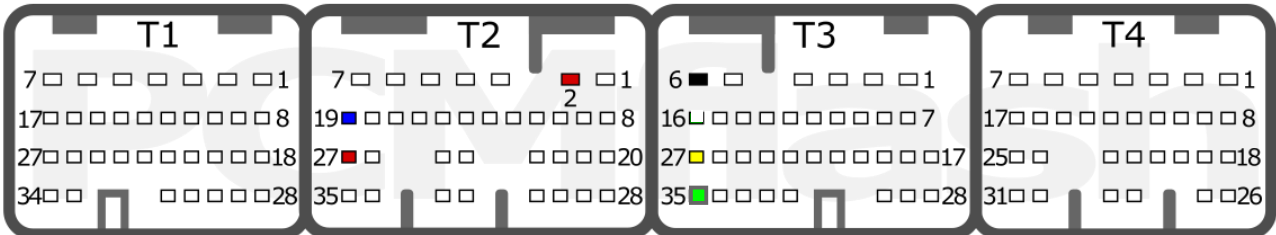

<b>+12V</b>	T2: 2, 27	<b>CAN-L</b>	T3: 35
<b>GND</b>	T3: 6	<b>CAN-H</b>	T3: 27
	T3: 16 (Not used)	<b>TEST</b>	T2: 19 (Not used)
* / cars without immo			

## FB (1.6L, 2.0L, 2.5L)

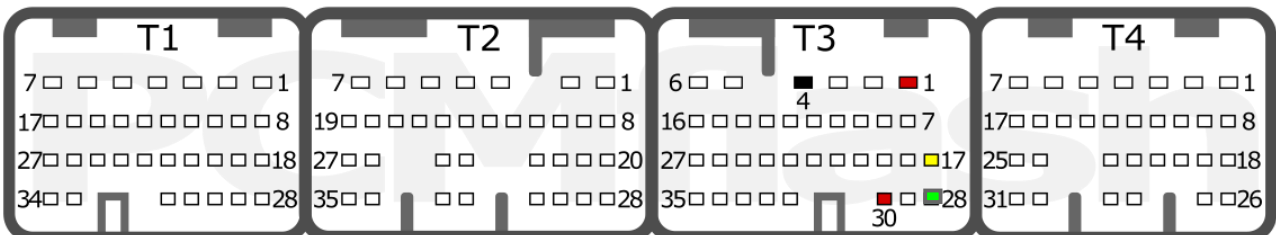

<b>+12V</b>	T3: 1, 30	<b>CAN-L</b>	T3: 28
<b>GND</b>	T3: 4	<b>CAN-H</b>	T3: 17

PCMtuner

Engine Control Unit

SH7058S

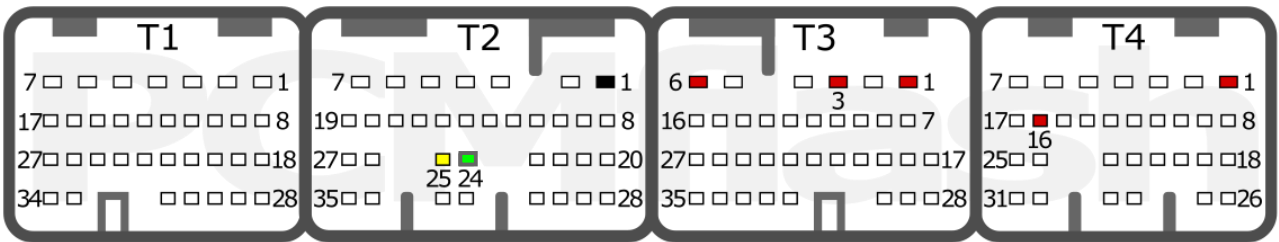

<b>+12V</b>	T3: 1, 3, 6; T4: 1, 16	<b>CAN-L</b>	T2: 24
<b>GND</b>	T2: 1	<b>CAN-H</b>	T2: 25

SUBARU STELLA 2008

[www.iecutool.com](http://www.iecutool.com)

v.1

2022-02-11

PCMtuner

Transmission Control Unit

SH7055/SH7058

SH7055

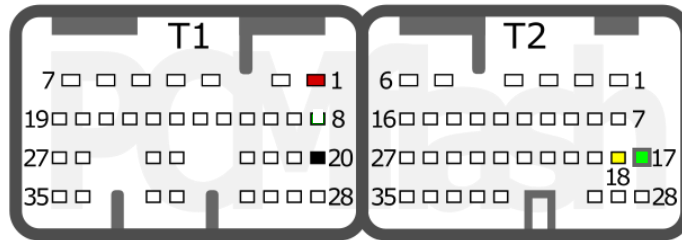

<b>+12V</b>	T1: 1	<b>CAN-L</b>	T2: 17
<b>GND</b>	T1: 20	<b>CAN-H</b>	T2: 18
	T1: 8 (Not used)		

SH7058

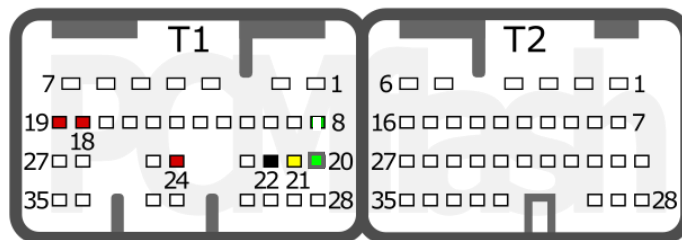

<b>+12V</b>	T1: 18, 19, 24	<b>CAN-L</b>	T1: 20
<b>GND</b>	T1: 22	<b>CAN-H</b>	T1: 21
	T1: 8 (Not used)		

SUBARU TCU

[www.iecutool.com](http://www.iecutool.com)

v.1

2022-06-07

<h1>PCMtuner</h1>	Engine Control Unit <h1>SH7055</h1>
-------------------	--

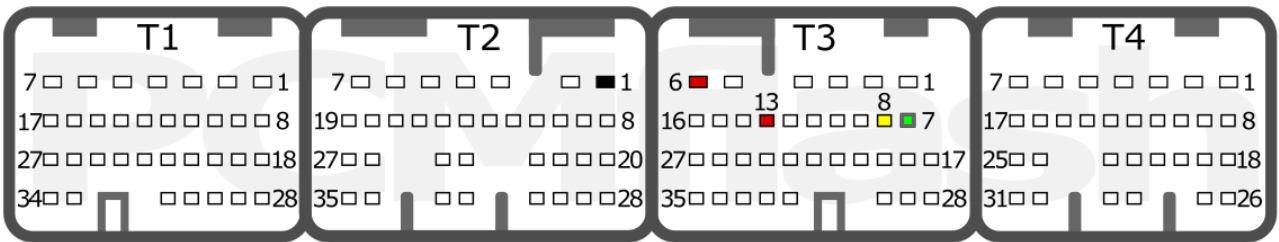

<b>+12V</b>	T3: 6, 13	<b>CAN-L</b>	T3: 7
<b>GND</b>	T2: 1	<b>CAN-H</b>	T3: 8

PCMtuner

Engine Control Unit

SH7055/SH7058

1.3, 1.5, 1.6L

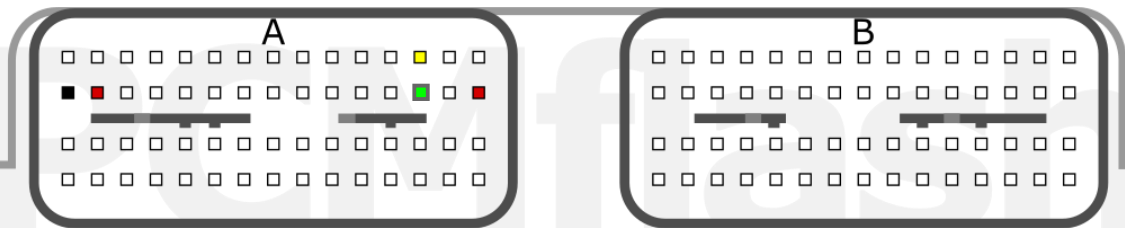

<b>+12V</b>	RED	<b>CAN-L</b>	GREEN
<b>GND</b>	BLACK	<b>CAN-H</b>	YELLOW

2.0, 2.4L

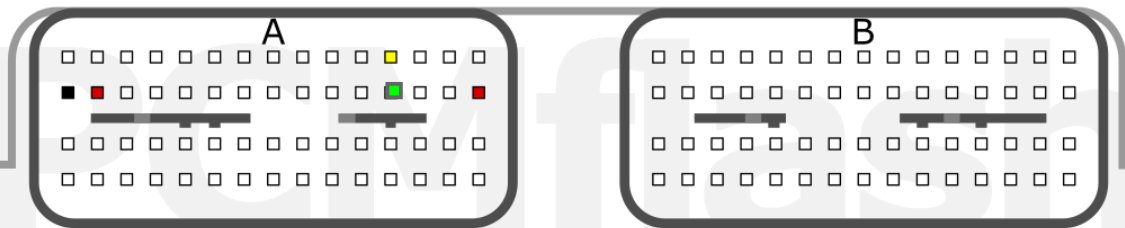

<b>+12V</b>	RED	<b>CAN-L</b>	GREEN
<b>GND</b>	BLACK	<b>CAN-H</b>	YELLOW

SUZUKI

[www.iecutool.com](http://www.iecutool.com)

v.1

2022-06-08



<h1>PCMtuner</h1>	Engine Control Unit <h2>SH7058</h2>
-------------------	--

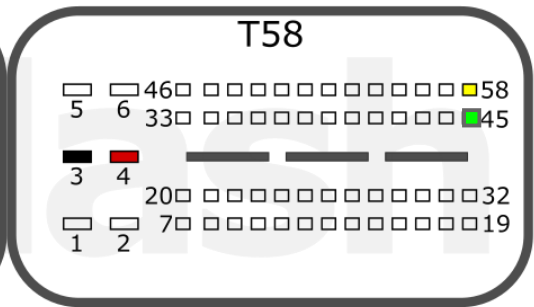
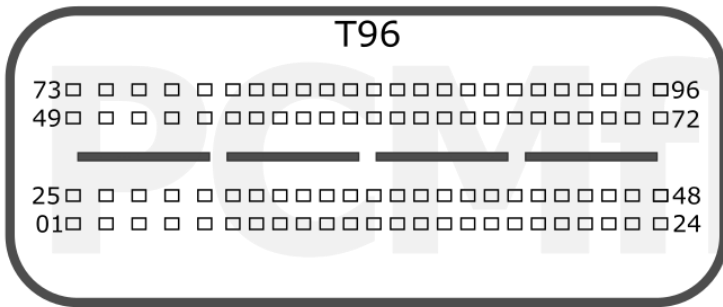

<b>+12V</b>	T58: 4	<b>CAN-L</b>	T58: 45
<b>GND</b>	T58: 3	<b>CAN-H</b>	T58: 58

PCMtuner

Engine Control Unit

SH7055

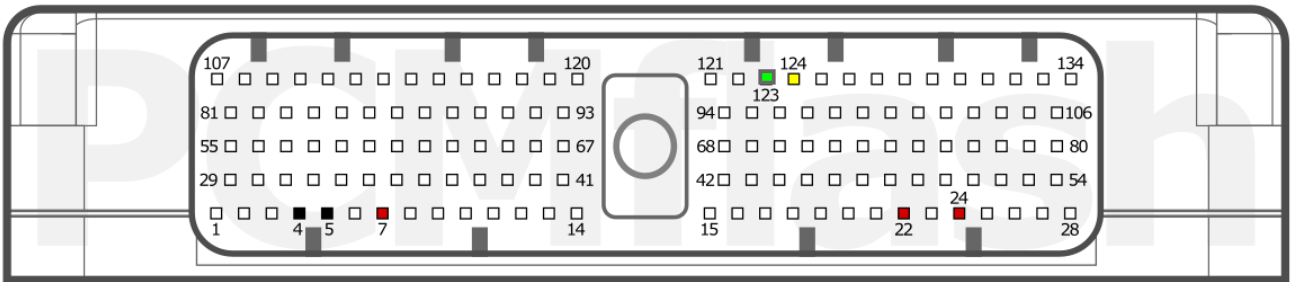

<b>+12V</b>	7, 22, 24	<b>CAN-L</b>	123
<b>GND</b>	4, 5	<b>CAN-H</b>	124

JAGUAR X 2001-2008, S/XJ/XK 2003-2006

v.1

2022-06-06