

PCMflash module 71

Bosch MEDC17 Bootloader

Contents/Оглавление

Contents/Оглавление.....	2
MED17.0 TC1767	7
MEDG17.0 TC1797	8
MED17.0.1 TC1767.....	9
MED17.1 TC1796	10
MED17.1.1 TC1797.....	11
MED17.1.6 TC1797.....	12
MED17.1.10 TC1793.....	13
MED17.1.21 TC1793.....	14
MED17.1.27 TC1793.....	15
MED17.1.61 TC1793.....	16
MED17.1.62 TC1793.....	17
ME17.2 TC1797.....	18
MED17.2 TC1796.....	19
MEV17.2 TC1796	20
MEVD17.2 TC1797.....	21
ME(V)17.2.1 TC1796.....	22
MEV17.2.2 TC1767	23
MEVD17.2.2 TC1797	24
MEVD17.2.3 TC1793	25
ME17.2.4 TC1793	26
MEVD17.2.4 TC1797	27
MEVD17.2.5 TC1797	28
MEVD17.2.6 TC1797	29
MEVD17.2.7 TC1797	30
MEVD17.2.8/17.2.9 TC1797.....	31
MEVD17.2.G TC1797.....	32
MEVD17.2.H TC1797.....	33
ME17.3 TC1724.....	34
MED17.3.1 TC1766.....	35
MED17.3.4 TC1797.....	36
MED17.3.5 TC1793.....	37
MED/MEV17.4 TC1766.....	38
MED/MEV(D)17.4.2 TC1767.....	39

MED17.4.4 TC1793.....	40
MEVD17.4.4 TC1793	41
ME(V)17.4.5 TC1796.....	42
MEV17.4.6 TC1796.....	43
ME17.5 TC1766.....	44
MED17.5 TC1766	45
MED17.5.1 TC1796.....	46
MED17.5.2 TC1767.....	47
MED17.5.5 TC1766.....	48
ME17.5.6 TC1767	49
MED17.5.20 TC1766.....	50
MED17.5.21 TC1782.....	51
MED17.5.25 TC1782.....	52
ME17.5.26 TC1724	53
ME17.7 TC1796.....	54
MED17.7.1 TC1797.....	55
MED17.7.2 TC1797.....	56
MED17.7.3 TC1797.....	57
MED17.7.3.1 TC1797	58
MED17.7.5 TC1793.....	59
MED17.7.7 TC1793.....	60
MED17.8.2 TC1767.....	61
MEVD17.8.4 TC1797	62
ME17.8.5 TC1762	63
M17.8.7 TC1762.....	64
ME17.8.8/ME17.8.8.1/ME17U6 TC1728/TC1782	65
MED17.8.10 TC1728/TC1782.....	66
MED17.8.21 TC1767.....	67
MED17.8.31 TC1797.....	68
ME17.8.32 TC1797	69
MED17.8.32 TC1793.....	70
MED17.8.34 TC1793.....	71
MEDC17.9 TC1793.....	72
MEG17.9.2 TC1767.....	73
MED17.9.3 TC1793.....	74
ME17.9.6 TC1767	75

ME17.9.7 TC1762	76
MED17.9.7 TC1767	77
ME(D)17.9.8 TC1767	78
MEG17.9.8 TC1767	79
MEDG17.9.8 TC1767	80
MED17.9.9 TC1793	81
M17.9.11 TC1762	82
ME17.9.11 TC1762	83
MEG17.9.12/17.9.13 TC1762	84
ME17.9.20 TC1782	85
MEG17.9.21 TC1724	86
ME17.9.21.1 TC1724	87
MED17.9.30 TC1793	88
ME17.9.51 TC1762	89
ME17.9.52 TC1782	90
ME17.9.55 TC1724	91
ME17.9.61 TC1724	92
MED17.9.63 TC1793	93
ME17.9.64 TC1724	94
ME17.9.71 TC1724	95
ME17.9.74 TC1762	96
EDC17C06 TC1766	97
EDC17C08 TC1766	98
EDC17C10 TC1797	99
EDC17C11 TC1766	100
EDC17C18 TC1766	101
EDC17C19 TC1792	102
EDC17C41 TC1797	103
EDC17C42 TC1767	104
EDC17C43 TC1797	105
EDC17C45 TC1767	106
EDC17C46 TC1767	107
EDC17C47 TC1782	108
EDC17C49 TC1797	109
EDC17C50 TC1797	110
EDC17C53 TC1767	111

EDC17C54 TC1797	112
EDC17C55 TC1767	113
EDC17C56 TC1797	114
EDC17C57 TC1793	115
EDC17C58 TC1793	116
EDC17C59 TC1767	117
EDC17C60 TC1793	118
EDC17C63 TC1724	119
EDC17C64 TC1797	120
EDC17C66 TC1793	121
EDC17C69 TC1793	122
EDC17C70 TC1793	123
EDC17C73 TC1793	124
EDC17C74 TC1793	125
EDC17C76 TC1793	126
EDC17C79 TC1797	127
EDC17C81 TC1782	128
EDC17C83 TC1793	129
EDC17C84 TC1782	130
EDC17CP01 TC1796	131
EDC17CP02 TC1766	132
EDC17CP04 TC1796	133
EDC17CP05 TC1796/TC1797	134
EDC17CP06 TC1796	135
EDC17CP07 TC1766	136
EDC17CP09 TC1796	137
EDC17CP10 TC1796	138
EDC17CP11 TC1796	139
EDC17CP14 TC1796	140
EDC17CP15 TC1796	141
EDC17CP16 TC1797	142
EDC17CP18 TC1796	143
EDC17CP19 TC1792	144
EDC17CP20 TC1796	145
EDC17CP21 TC1792	146
EDC17CP22 TC1796	147

EDC17CP24 TC1796	148
EDC17CP27 TC1796	149
EDC17CP37 TC1766	150
EDC17CP42 TC1797	151
EDC17CP44 TC1797	152
EDC17CP45 TC1797	153
EDC17CP46 TC1797	154
EDC17CP47 TC1797	155
EDC17CP48 TC1797	156
EDC17CP49 TC1797	157
EDC17CP50 TC1797	158
EDC17CP52 TC1797	159
EDC17CP54 AMAROK TC1793	160
EDC17CP54 AUDI TC1793	161
EDC17CP55 TC1793	162
EDC17CP57 TC1793	163
EDC17CP58 TC1767	164
EDC17CP60 TC1793	165
EDC17CP62 TC1793	166
EDC17CP65 TC1793	167
EDC17CP68 TC1797	168
EDC17CP74 TC1793	169
EDC17CV41 TC1797	170
EDC17CV42 TC1797	172
EDC17CV43/CV44 TC1767	173
EDC17CV45 TC1782	174
EDC17CV52 TC1797	175
EDC17CV53/CV54/CV56 TC1767	176
EDC17U01 TC1766	177
EDC17U05 TC1766	178
DCU17CV51 TC1724	179
DCU17HD01 TC1766	180
DCU17PC01 TC1766	181
DCU17PC42/PC43 TC1724	182

PCMflash

Engine Control Unit

MED17.0 TC1767

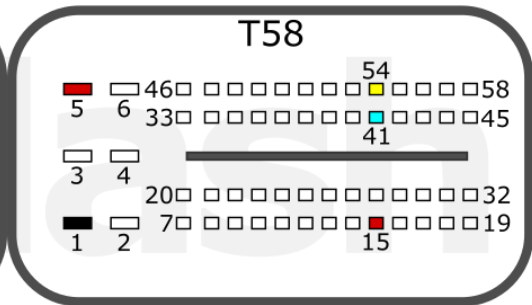
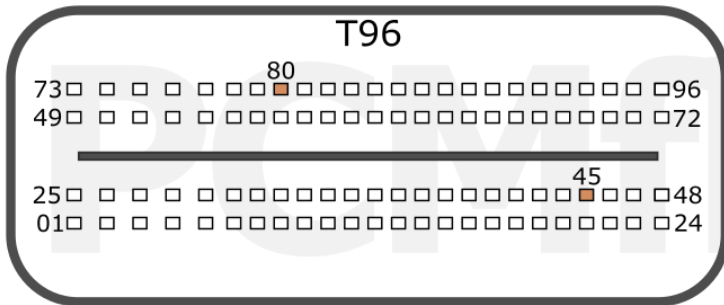

+12V	T58: 5, 15	CAN-L	T58: 41
GND	T58: 1	CAN-H	T58: 54
GPT	T96: 80, 45		

FORD

VOLVO

pcmflash.ru

v.2

2022-06-08

PCMflash

Engine Control Unit

MEDG17.0 TC1797

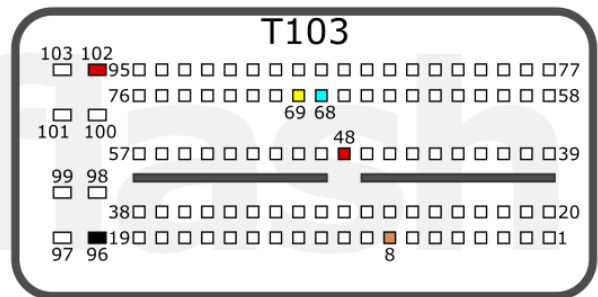
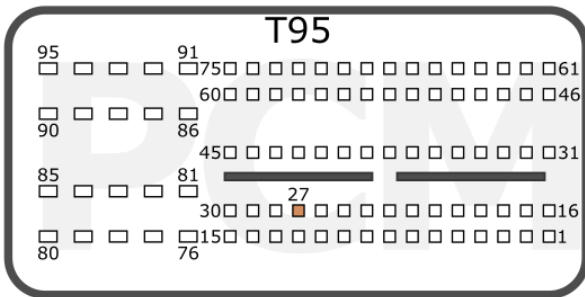

+12V	T103: 102, 48	CAN-L	T103: 68
GND	T103: 96	CAN-H	T103: 69
GPT	T103:8, T95: 27		

FORD

pcmflash.ru

v.1

2021-09-30

PCMflash

Engine Control Unit

MED17.0.1 TC1767

Connection version 1

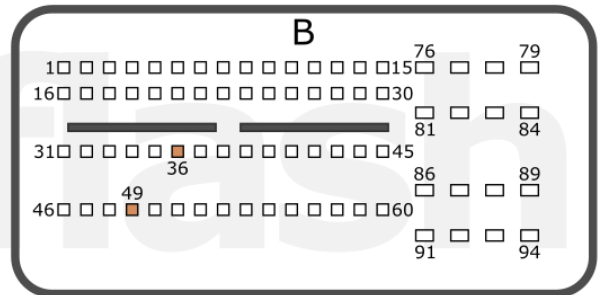
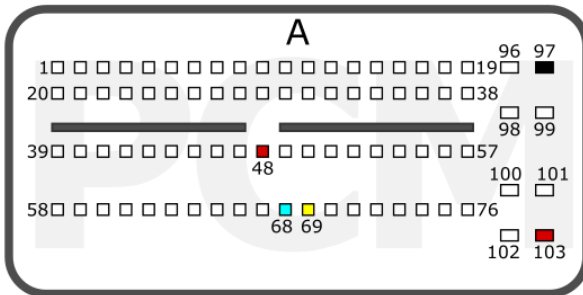

+12V	A: 48, 103	CAN-L	A: 68
GND	A: 97	CAN-H	A: 69
GPT	B: 36, 49		

Connection version 2

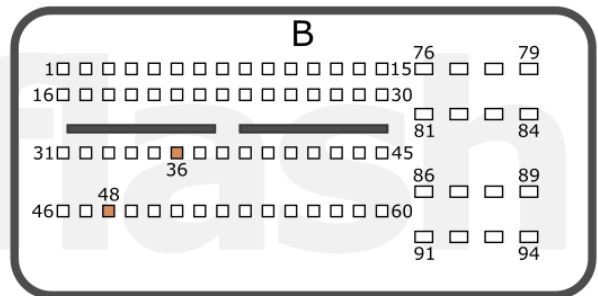
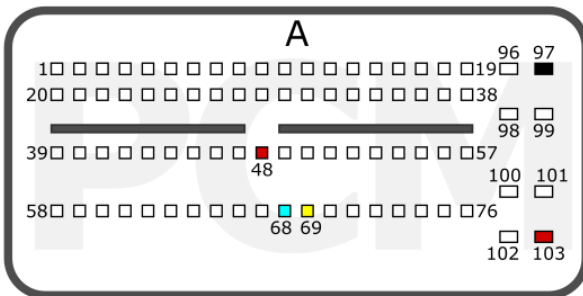

+12V	A: 48, 103	CAN-L	A: 68
GND	A: 97	CAN-H	A: 69
GPT	B: 36, 48		

FORD

PCMflash

Engine Control Unit

MED17.1 TC1796

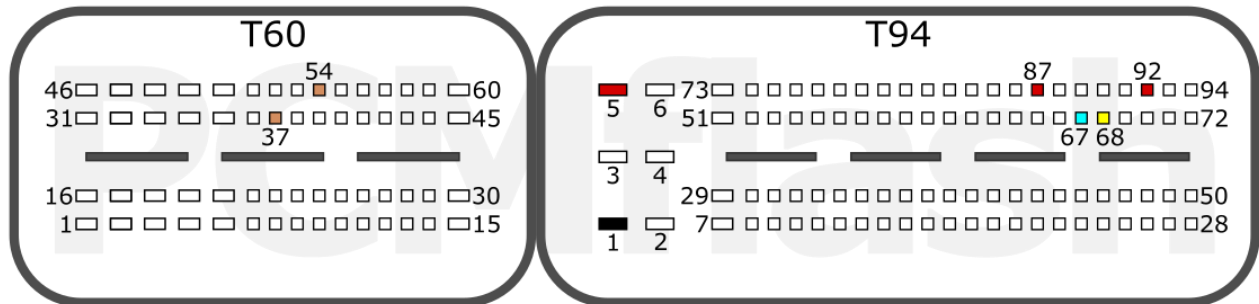

+12V	T94: 5, 87, 92	CAN-L	T94: 67
GND	T94: 1	CAN-H	T94: 68
GPT	T60: 37, 54		

VAG

pcmflash.ru

v.1

2021-09-08

PCMflash

Engine Control Unit

MED17.1.1 TC1797

AUDI

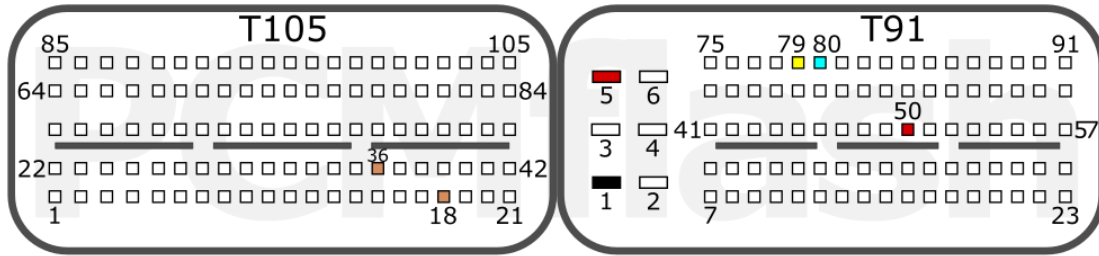

+12V	T91: 5, 50	CAN-L	T91: 80
GND	T91: 1	CAN-H	T91: 79
GPT	T105: 18, 36		

VOLKSWAGEN

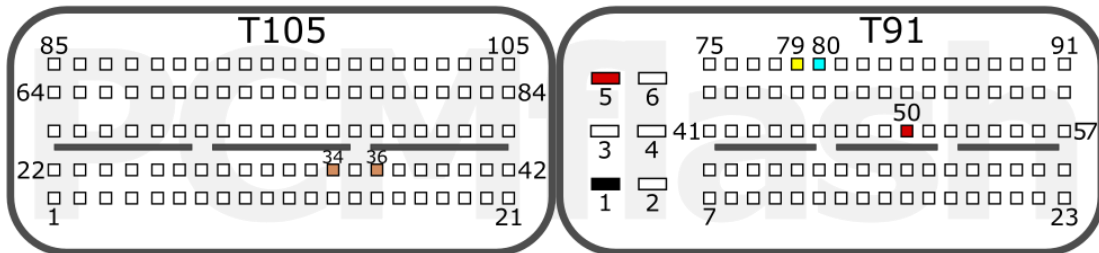

+12V	T91: 5, 50	CAN-L	T91: 80
GND	T91: 1	CAN-H	T91: 79
GPT	T105: 34, 36		

VAG

PCMflash

Engine Control Unit

MED17.1.6 TC1797

VAG

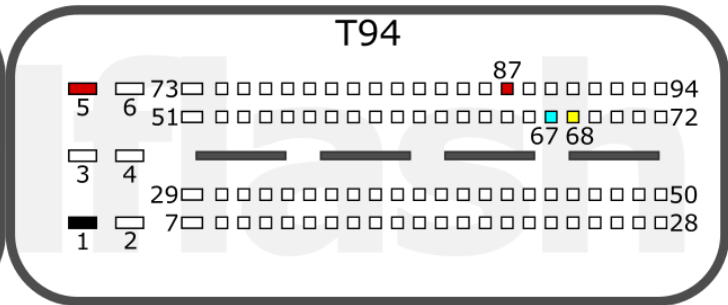
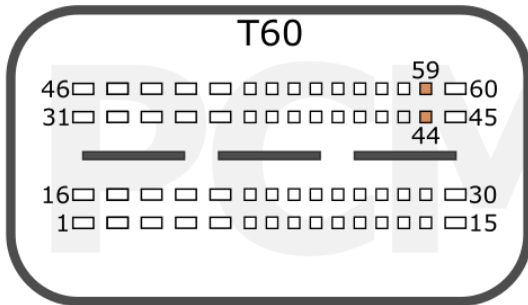

+12V	T94: 5, 87	CAN-L	T94: 67
GND	T94: 1	CAN-H	T94: 68
GPT	T60: 44, 59		

PORSCHE

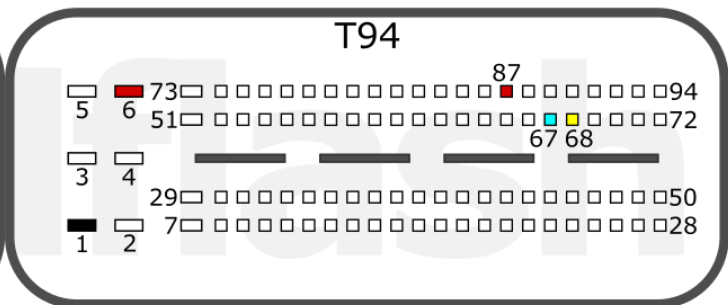
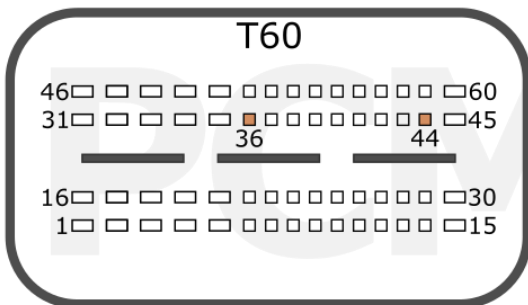

+12V	T94: 6, 87	CAN-L	T94: 67
GND	T94: 1	CAN-H	T94: 68
GPT	T60: 44, 36		

PORSCHE

VAG

pcmflash.ru

v.1

2021-09-11

PCMflash

Engine Control Unit

MED17.1.10 TC1793

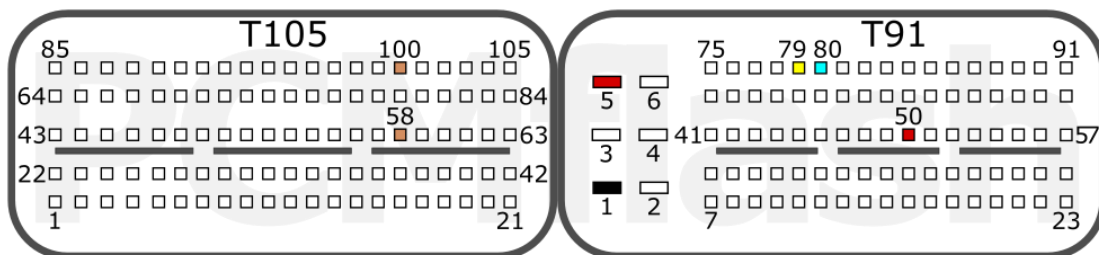

+12V	T91: 5, 50	CAN-L	T91: 80
GND	T91: 1	CAN-H	T91: 79
GPT	T105: 100, 58		

AUDI

pcmflash.ru

v.1

2021-09-11

PCMflash

Engine Control Unit

MED17.1.21 TC1793

Connection version 1

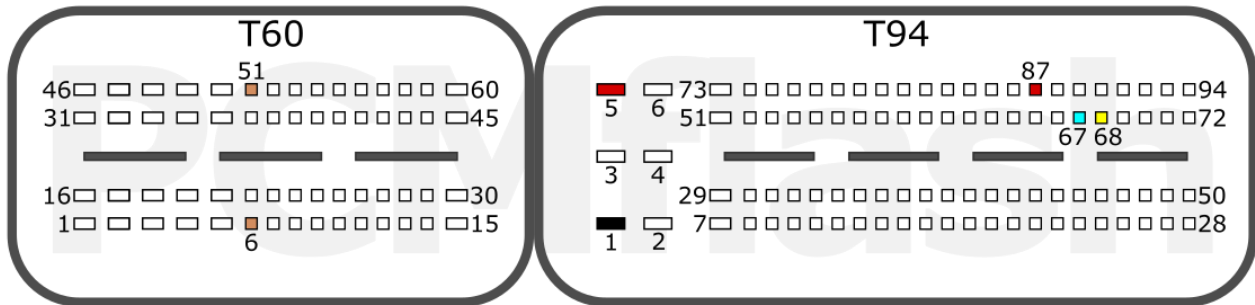

+12V	T94: 5, 87	CAN-L	T94: 67
GND	T94: 1	CAN-H	T94: 68
GPT	T60: 51, 6		

Connection version 2

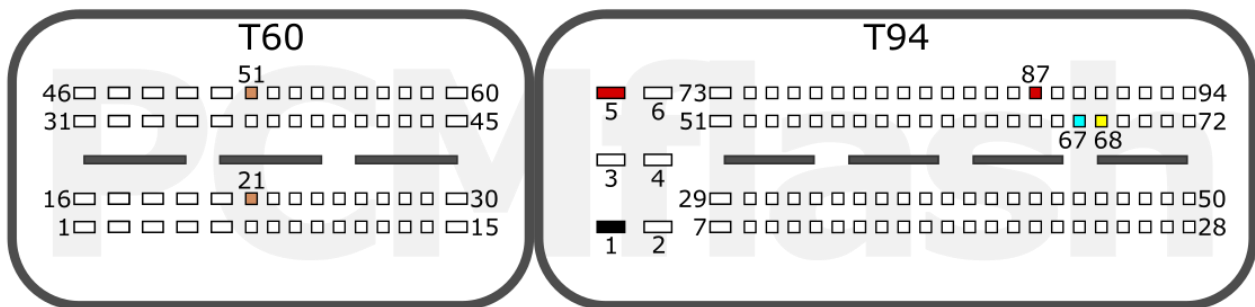

+12V	T94: 5, 87	CAN-L	T94: 67
GND	T94: 1	CAN-H	T94: 68
GPT	T60: 21, 51		

VAG

pcmflash.ru

v.1

2021-10-14

PCMflash

Engine Control Unit
MED17.1.27 TC1793

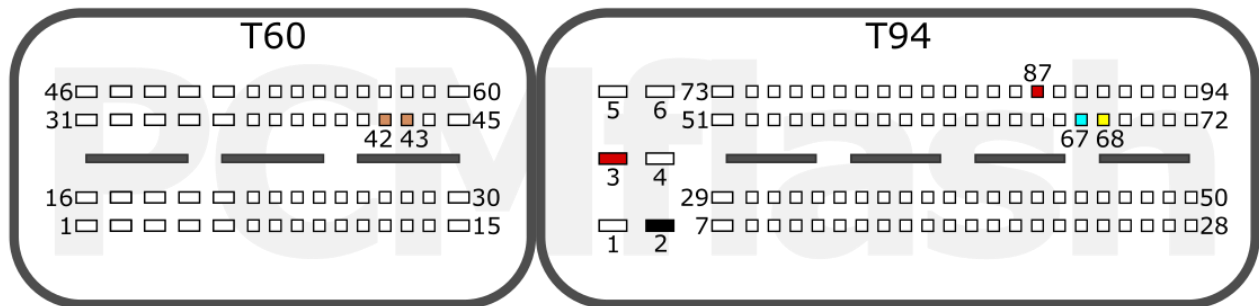

+12V	T94: 3, 87	CAN-L	T94: 67
GND	T94: 2	CAN-H	T94: 68
GPT	T60: 42, 43		

VAG

pcmflash.ru

v.1

2021-10-09

PCMflash

Engine Control Unit

MED17.1.61 TC1793

Connection version 1

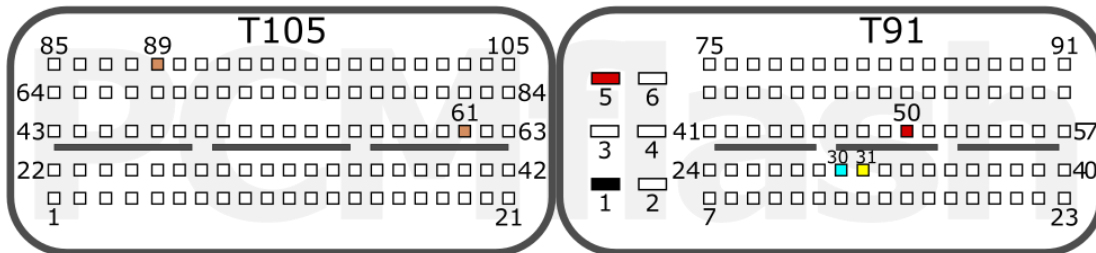

+12V	T91: 5, 50	CAN-L	T91: 30
GND	T91: 1	CAN-H	T91: 31
GPT	T105: 61, 89		

Connection version 2

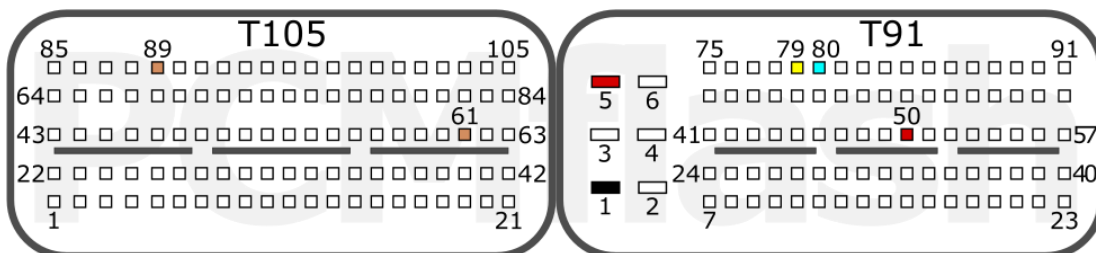

+12V	T91: 5, 50	CAN-L	T91: 80
GND	T91: 1	CAN-H	T91: 79
GPT	T105: 61, 89		

VAG

pcmflash.ru

v.2

2024-05-08

PCMflash

Engine Control Unit

MED17.1.62 TC1793

VOLKSWAGEN

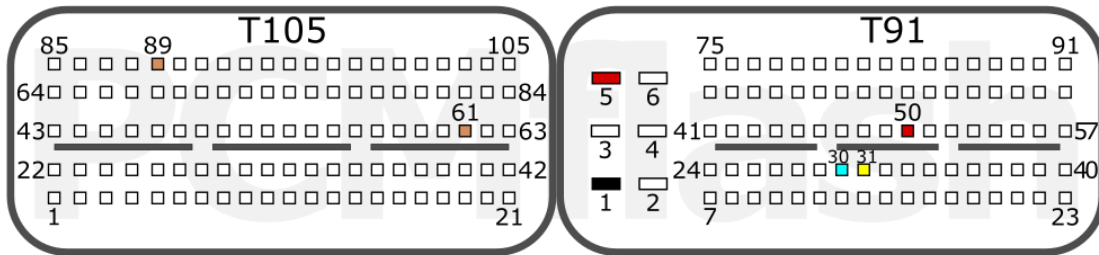

+12V	T91: 5, 50	CAN-L	T91: 30
GND	T91: 1	CAN-H	T91: 31
GPT	T105: 61, 89		

AUDI

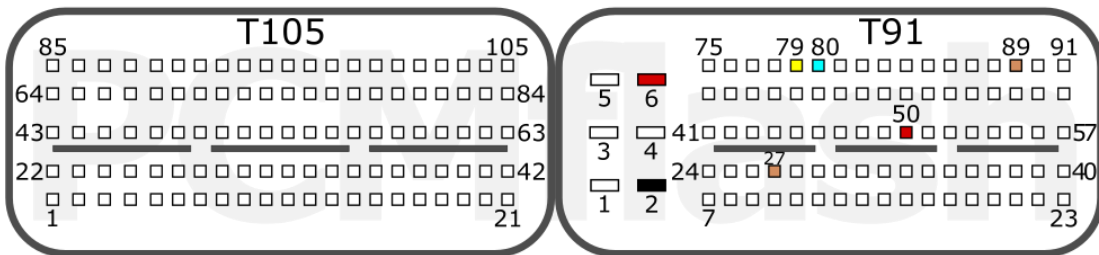

+12V	T91: 6, 50	CAN-L	T91: 80
GND	T91: 2	CAN-H	T91: 79
GPT	T105: 27, 89		

VAG

PCMflash

Engine Control Unit

MED17.2 TC1796

Connection version 1

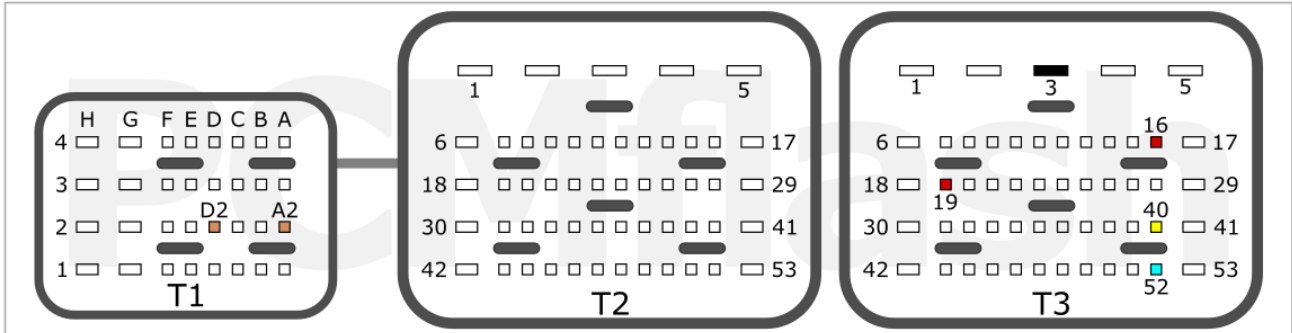

+12V	T3: 16, 19	CAN-L	T3: 52
GND	T3: 3	CAN-H	T3: 40
GPT	T1: A2, D2		

Connection version 2

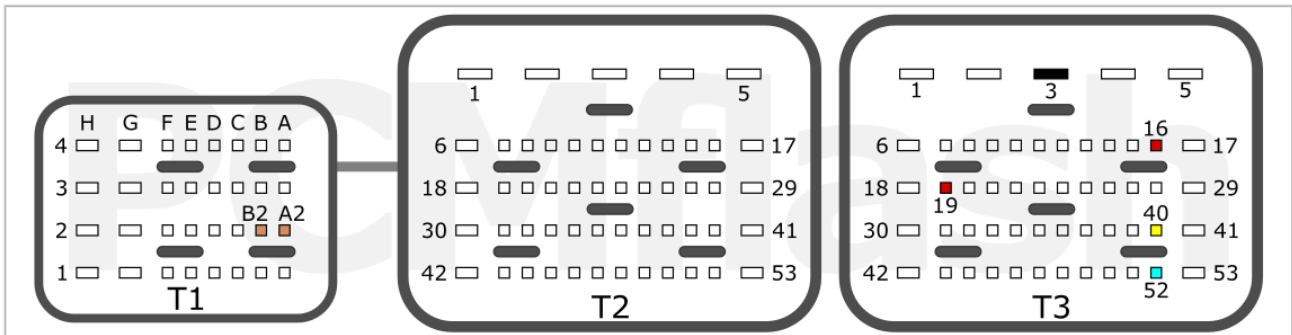

+12V	T3: 16, 19	CAN-L	T3: 52
GND	T3: 3	CAN-H	T3: 40
GPT	T1: B2, A2		

MINI

pcmflash.ru

v.1

2021-11-01

PCMflash

Engine Control Unit

MEV17.2 TC1796

TYPE 1



+12V	T58: 1, 7	CAN-L	T58: 33
GND	T58: 6	CAN-H	T58: 46
GPT	T96: 22, 23		

TYPE 2

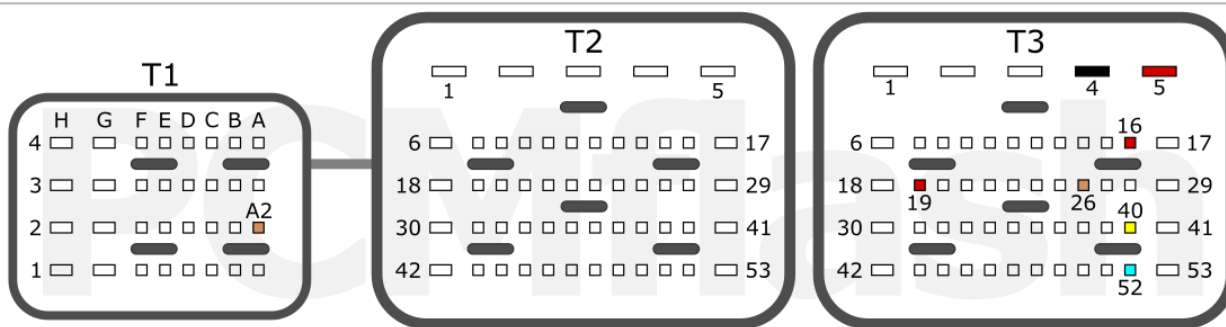

+12V	T3: 5, 16, 19	CAN-L	T3: 52
GND	T3: 4	CAN-H	T3: 40
GPT	T1: A2, T3: 26		

BMW

PCMflash

Engine Control Unit

MEVD17.2 TC1797

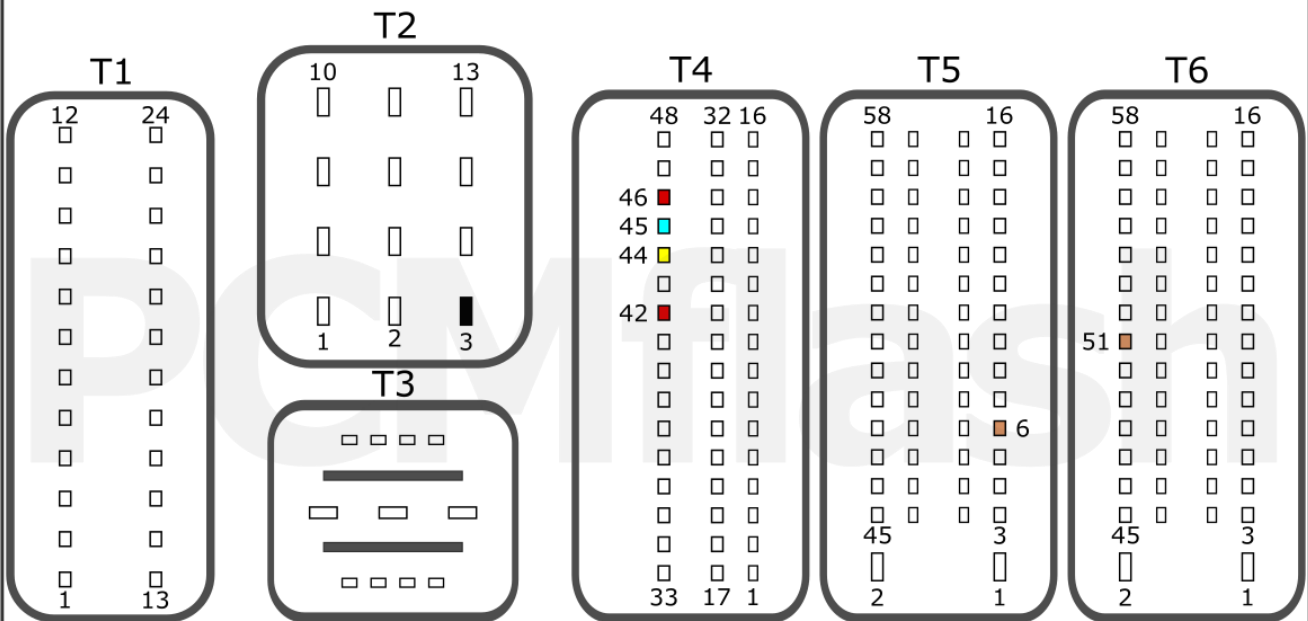

+12V	T4: 42, 46	CAN-L	T4: 45
GND	T2: 3	CAN-H	T4: 44
GPT	T6: 51, T5: 6		

BMW

pcmflash.ru

v.1

2021-09-04

PCMflash

Engine Control Unit

ME(V)17.2.1 TC1796

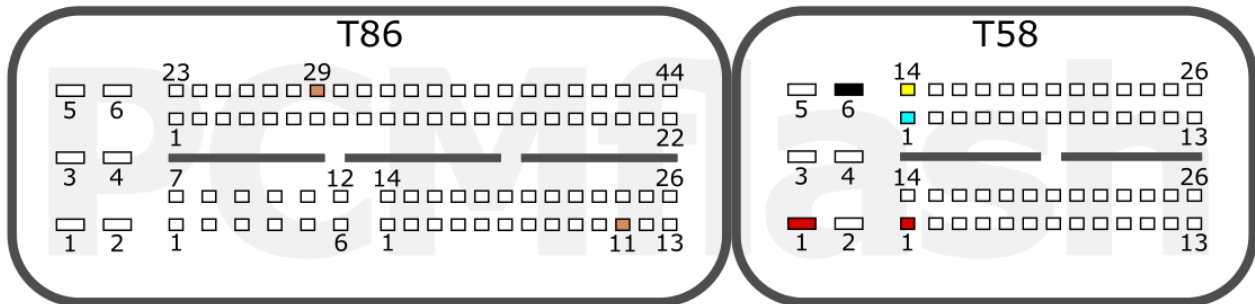

+12V	T58: 1, 1	CAN-L	T58: 1
GND	T58: 6	CAN-H	T58: 14
GPT	T86: 29, 11		

BMW

pcmflash.ru

v.2

2021-12-14

PCMflash

Engine Control Unit

MEV17.2.2 TC1767

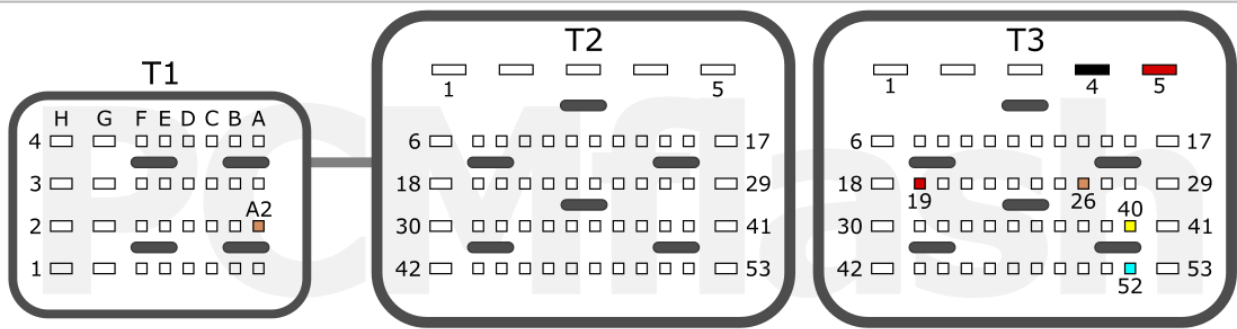

+12V	T3: 5, 19	CAN-L	T3: 52
GND	T3: 4	CAN-H	T3: 40
GPT	T1: A2, T3:26		

BMW

pcmflash.ru

v.1

2021-10-10

PCMflash

Engine Control Unit

MEVD17.2.2 TC1797

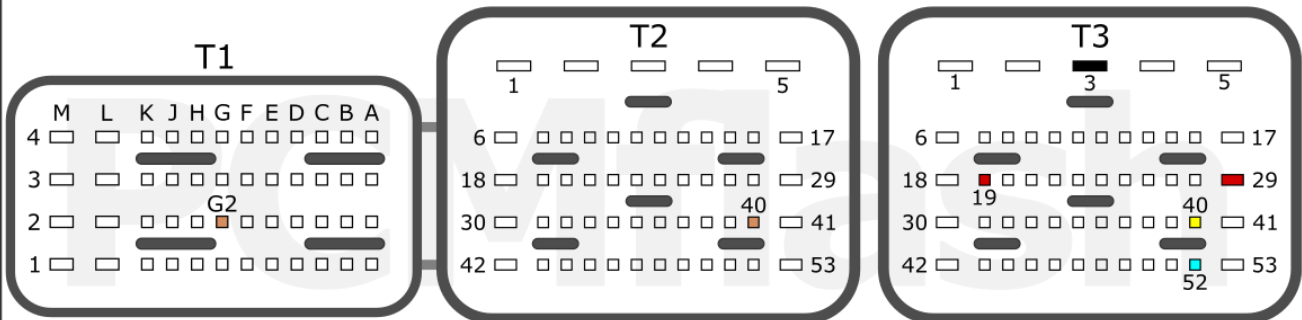

+12V	T3: 19, 29	CAN-L	T3: 52
GND	T3: 3	CAN-H	T3: 40
GPT	T2: 40, T1: G2		

MINI

pcmflash.ru

v.1

2021-10-22

PCMflash

Engine Control Unit

MEVD17.2.3 TC1793

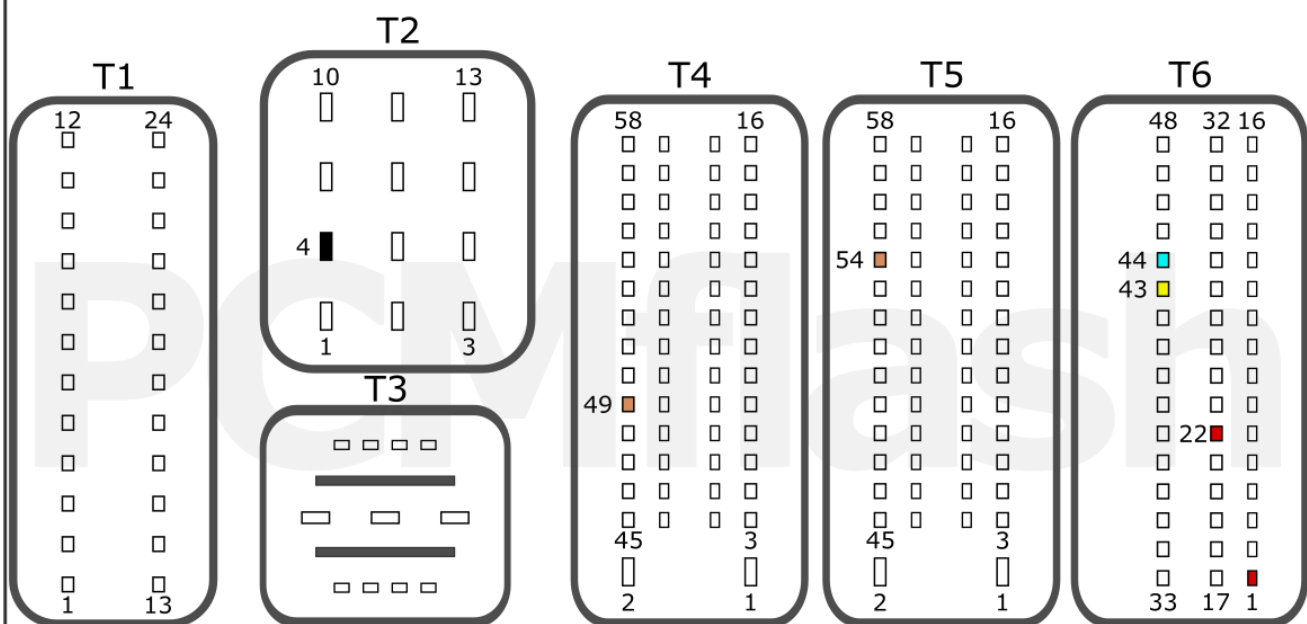

+12V	T6: 22, 1	CAN-L	T6: 44
GND	T2: 4	CAN-H	T6: 43
GPT	T5: 54, T4: 49		

BMW

pcmflash.ru

v.1

2021-08-24

PCMflash

Engine Control Unit

ME17.2.4 TC1793

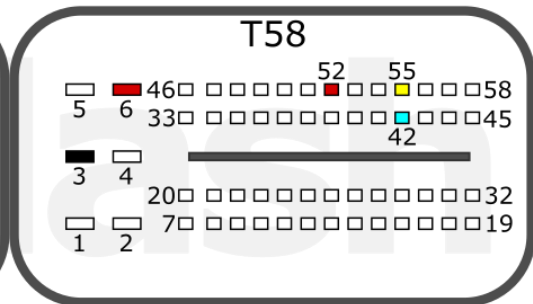
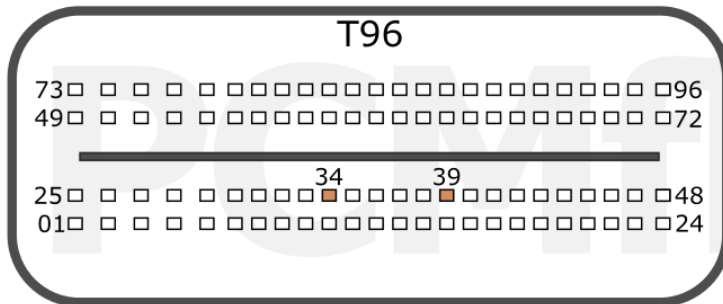

+12V	T58: 6, 52	CAN-L	T58: 42
GND	T58: 3	CAN-H	T58: 55
GPT	T96: 34, 39		

BMW

pcmflash.ru

v.1

2021-09-10

PCMflash

Engine Control Unit

MEVD17.2.4 TC1797

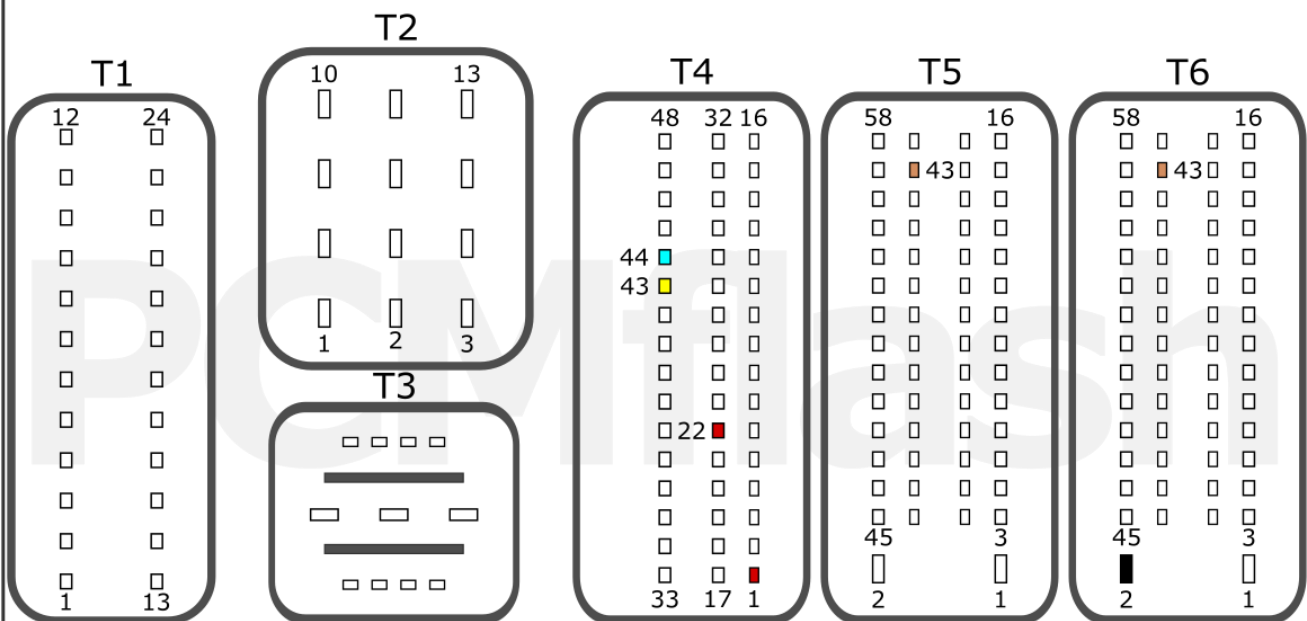

+12V	T4: 1, 22	CAN-L	T4: 44
GND	T6: 2	CAN-H	T4: 43
GPT	T5: 43, T6: 43		

BMW

pcmflash.ru

v.1

2021-09-16

PCMflash

Engine Control Unit

MEVD17.2.5 TC1797

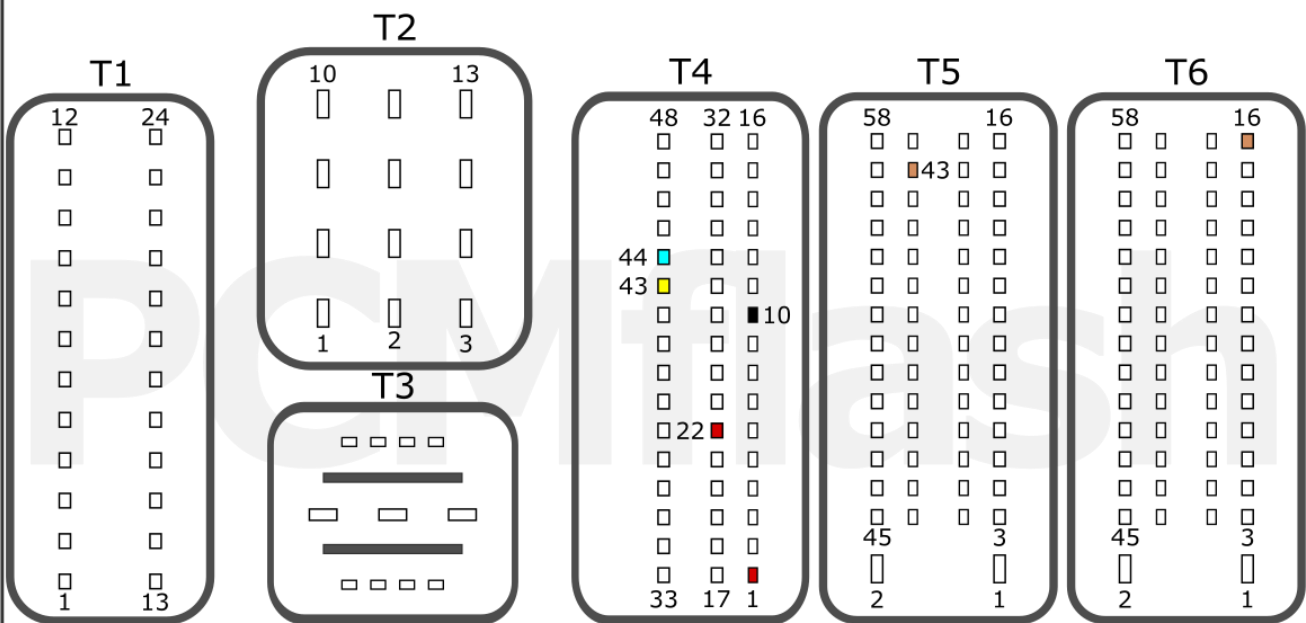

+12V	T4: 22, 1	CAN-L	T4: 44
GND	T4: 10	CAN-H	T4: 43
GPT	T6: 16, T5: 43		

BMW

pcmflash.ru

v.1

2021-10-11

PCMflash

Engine Control Unit

MEVD17.2.6 TC1797

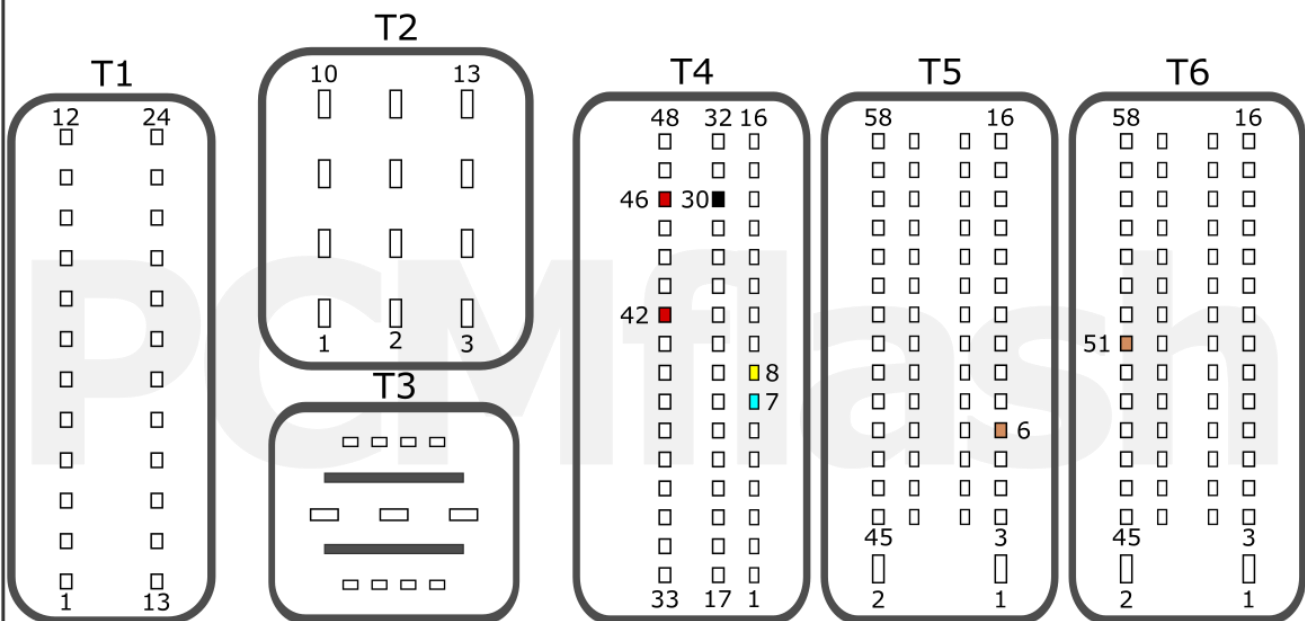

+12V	T4: 42, 46	CAN-L	T4: 7
GND	T4: 30	CAN-H	T4: 8
GPT	T5: 6, T6: 51		

BMW

pcmflash.ru

v.1

2021-08-29

PCMflash

Engine Control Unit

MEVD17.2.7 TC1797

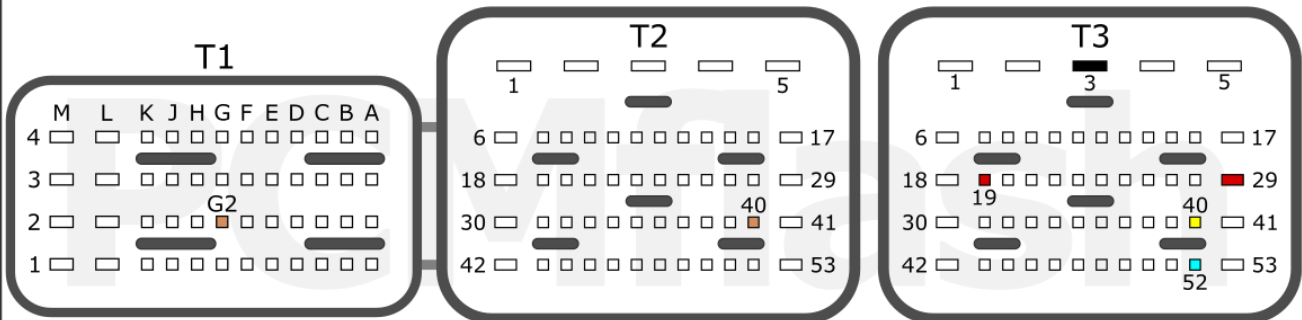

+12V	T3: 19, 29	CAN-L	T3: 52
GND	T3: 3	CAN-H	T3: 40
GPT	T2: 40, T1: G2		

MINI

pcmflash.ru

v.1

2021-10-12

PCMflash

Engine Control Unit

MEVD17.2.8/17.2.9 TC1797

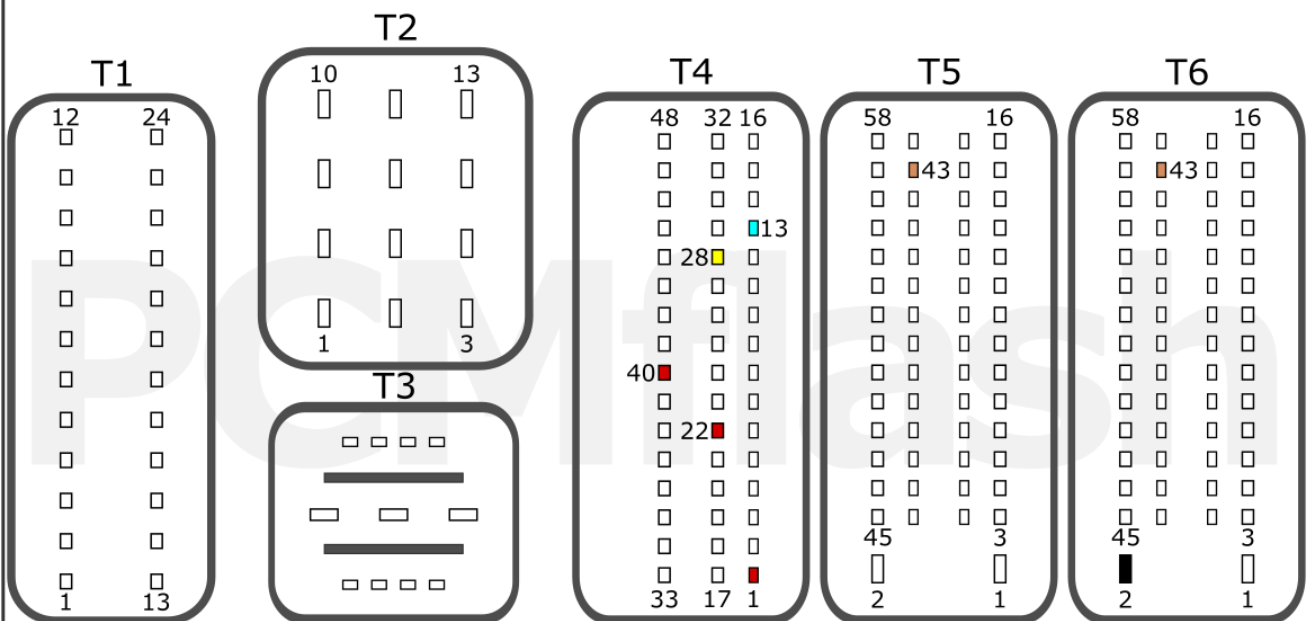

+12V	T4: 40, 22, 1	CAN-L	T4: 13
GND	T6: 2	CAN-H	T4: 28
GPT	T6: 43, T5: 43		

BMW

pcmflash.ru

v.2

2022-01-24

PCMflash

Engine Control Unit

MEVD17.2.G TC1797

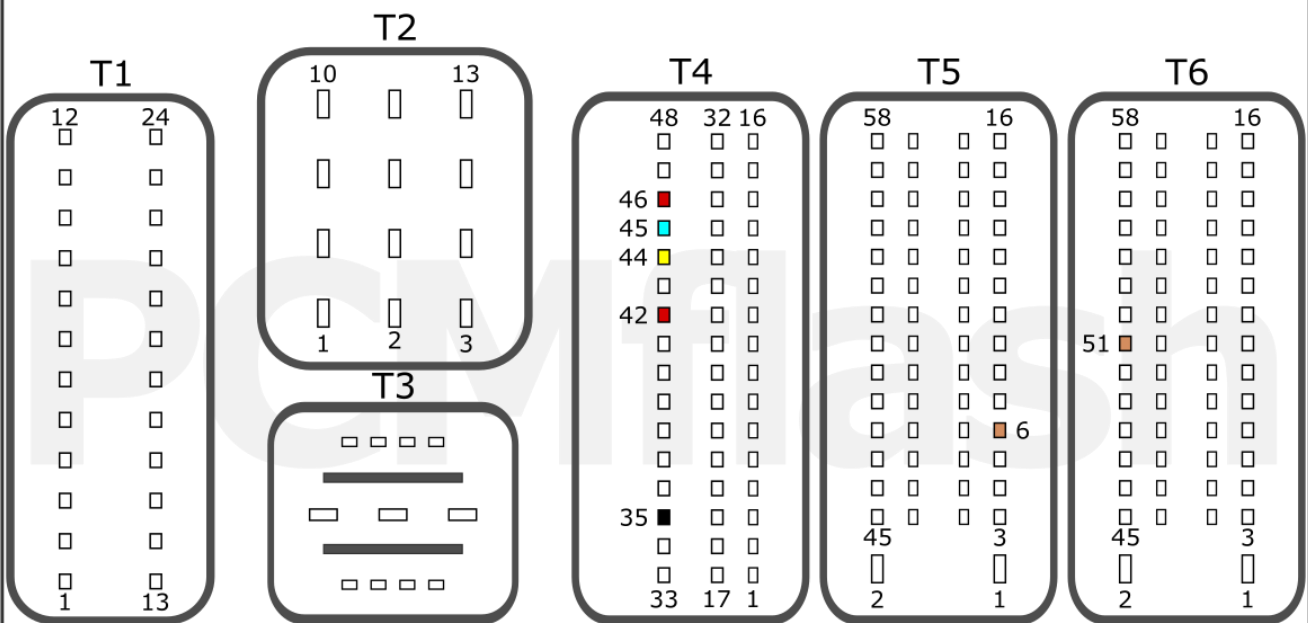

+12V	T4: 42, 46	CAN-L	T4: 45
GND	T4: 35	CAN-H	T4: 44
GPT	T6: 51, T5: 6		

BMW

pcmflash.ru

v.1

2021-10-08

PCMflash

Engine Control Unit

MEVD17.2.H TC1797

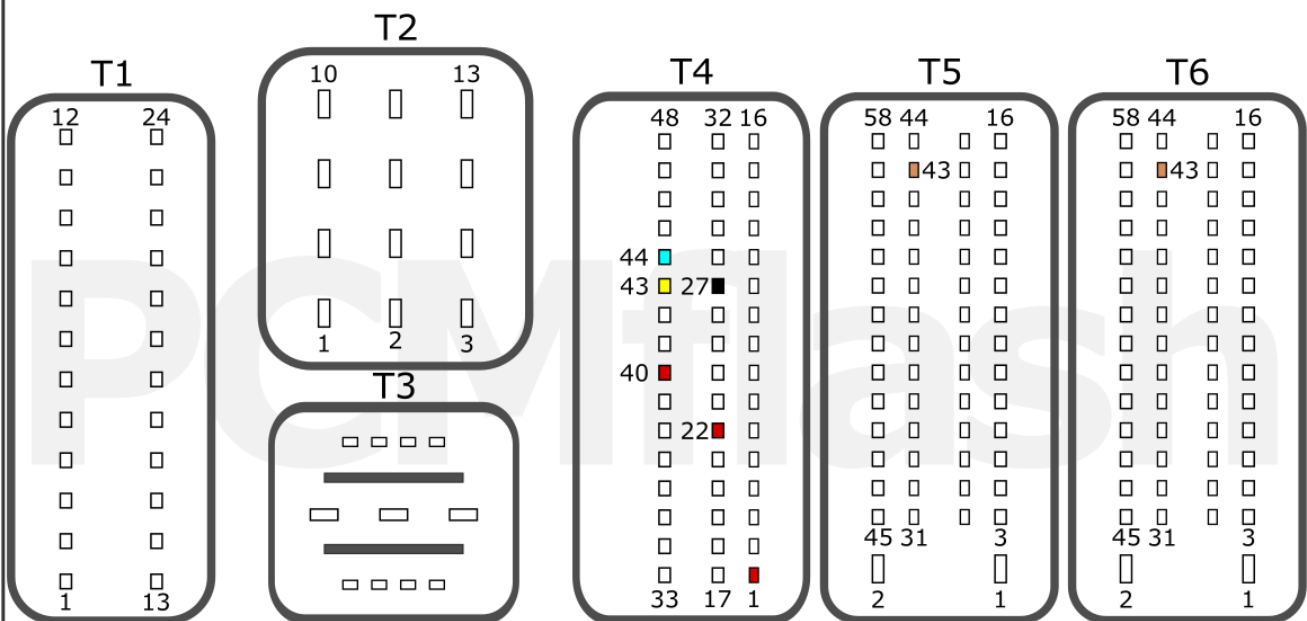

+12V	T4: 1, 22, 40	CAN-L	T4: 44
GND	T4: 27	CAN-H	T4: 43
GPT	T5: 43, T6: 43		

BMW

pcmflash.ru

v.1

2021-10-31

PCMflash

Engine Control Unit

ME17.3 TC1724

FIAT

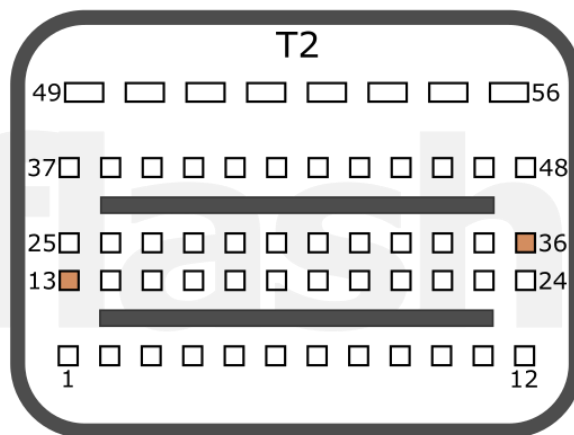
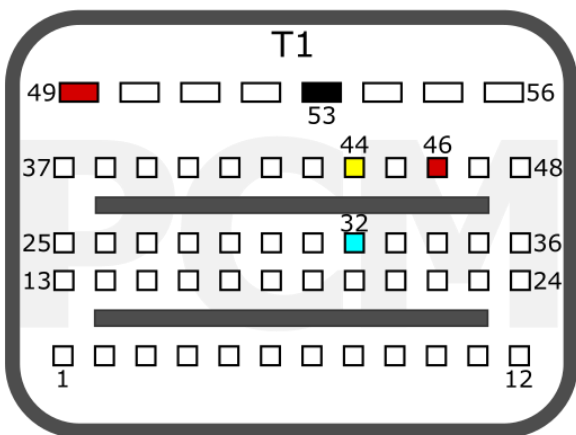

+12V	T1: 49, 46	CAN-L	T1: 32
GND	T1: 53	CAN-H	T1: 44
GPT	T2: 36, 13		

OPEL

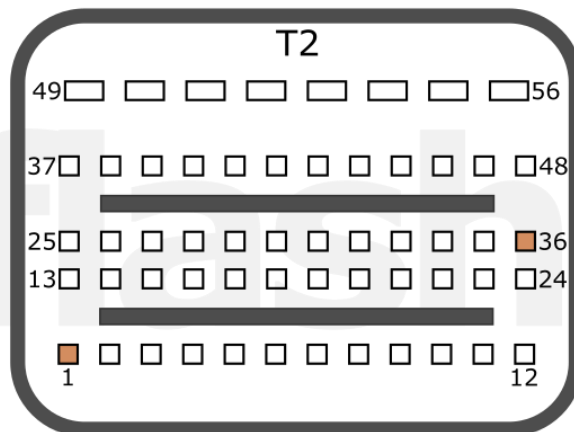
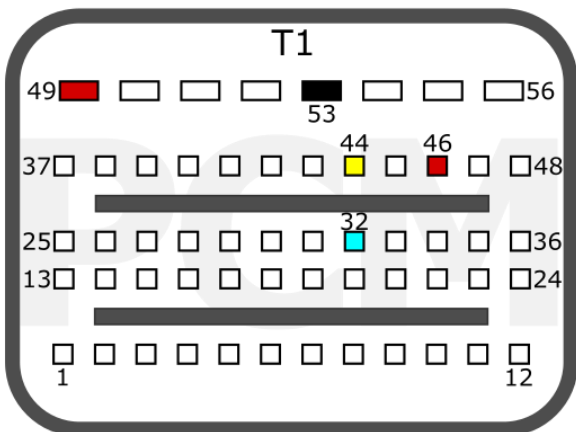

+12V	T1: 49, 46	CAN-L	T1: 32
GND	T1: 53	CAN-H	T1: 44
GPT	T2: 36, 1		

FIAT

OPEL

pcmflash.ru

v.1

2021-10-31

PCMflash

Engine Control Unit

MED17.3.1 TC1766

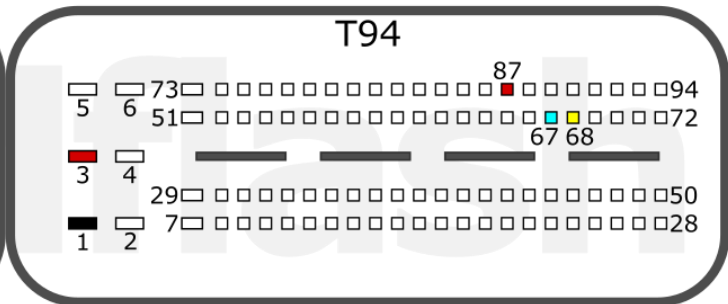
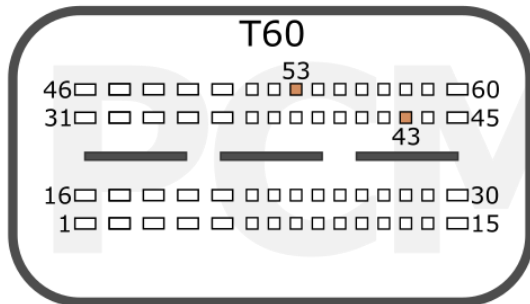

+12V	T94: 3, 87	CAN-L	T94: 67
GND	T94: 1	CAN-H	T94: 68
GPT	T60: 53, 43		

LANCIA

pcmflash.ru

v.1

2021-10-12

PCMflash

Engine Control Unit

MED17.3.4 TC1797

T105

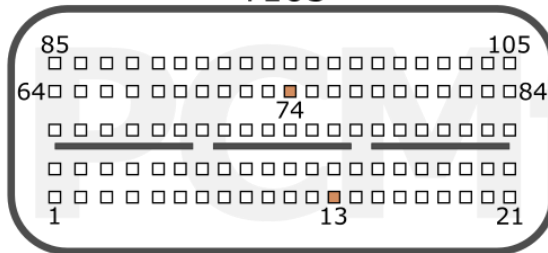

T91

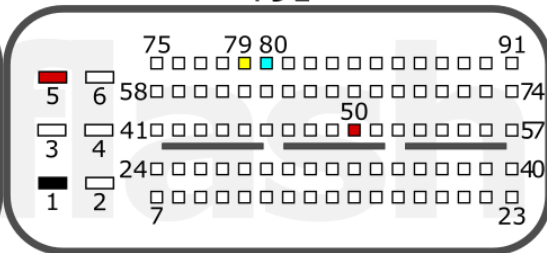

+12V	T91: 5, 50	CAN-L	T91: 80
GND	T91: 1	CAN-H	T91: 79
GPT	T105: 13, 74		

MASERATI

pcmflash.ru

v.1

2021-10-11

PCMflash

Engine Control Unit

MED17.3.5 TC1793

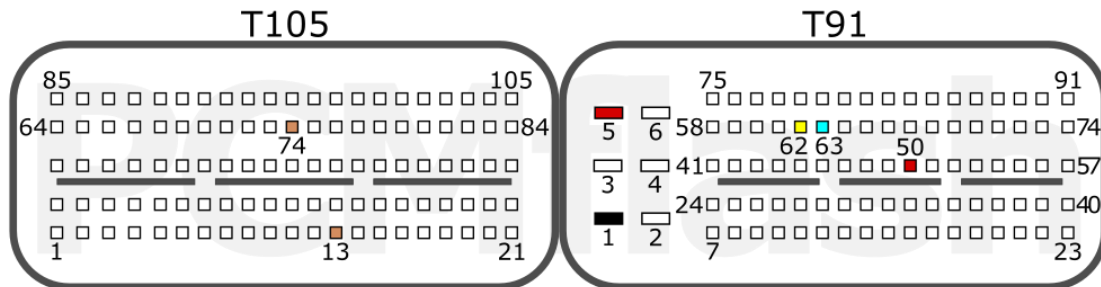

+12V	T91: 5, 50	CAN-L	T91: 63
GND	T91: 1	CAN-H	T91: 62
GPT	T105: 74, 13		

FERRARI

pcmflash.ru

v.1

2021-12-03

PCMflash

Engine Control Unit

MED/MEV17.4 TC1766

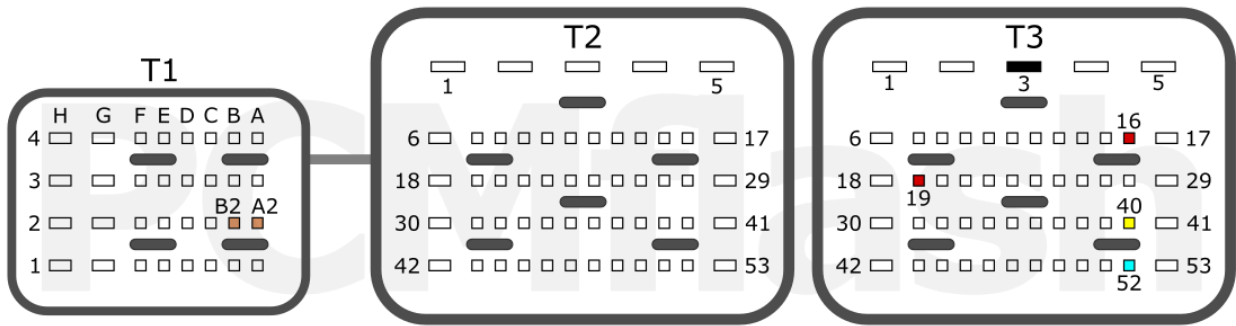

+12V	T3: 16, 19	CAN-L	T3: 52
GND	T3: 3	CAN-H	T3: 40
GPT	T1: A2, B2		

PSA

pcmflash.ru

v.2

2021-12-14

PCMflash

Engine Control Unit

MED/MEV(D)17.4.2 TC1767

Connection version 1

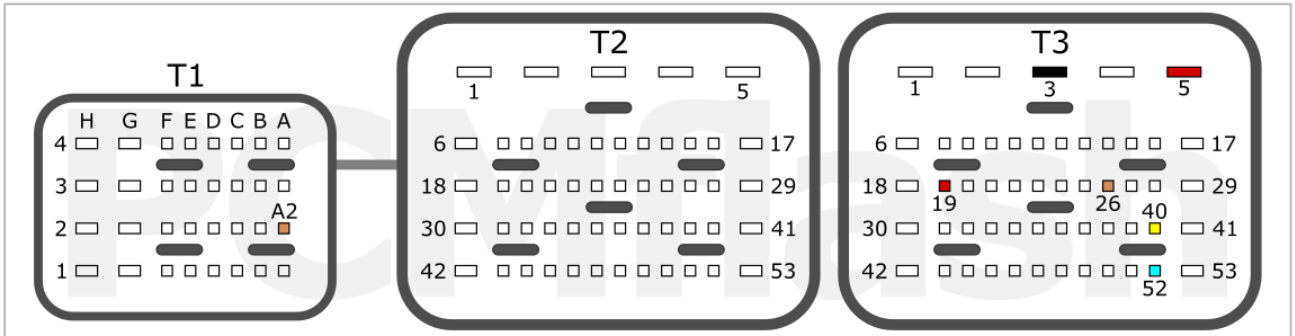

+12V	T3: 5, 19	CAN-L	T3: 52
GND	T3: 3	CAN-H	T3: 40
GPT	T1: A2, T3: 26		

Connection version 2

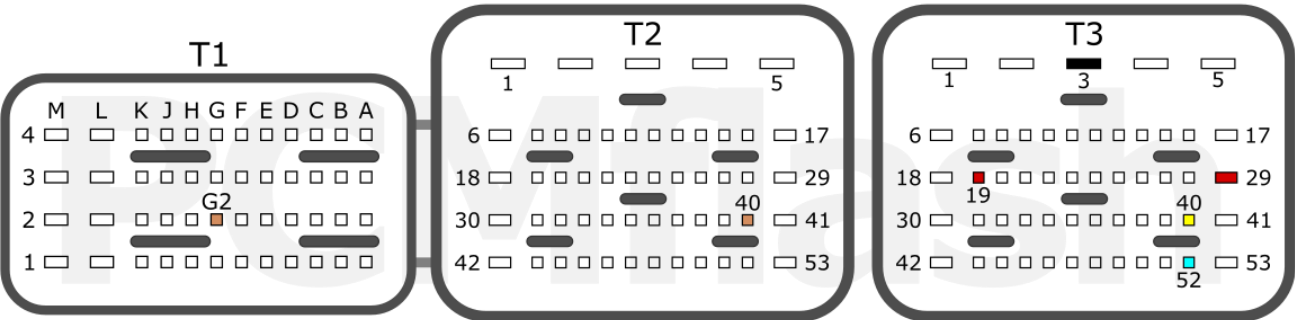

+12V	T3: 19, 29	CAN-L	T3: 52
GND	T3: 3	CAN-H	T3: 40
GPT	T2: 40, T1: G2		

Connection version 3

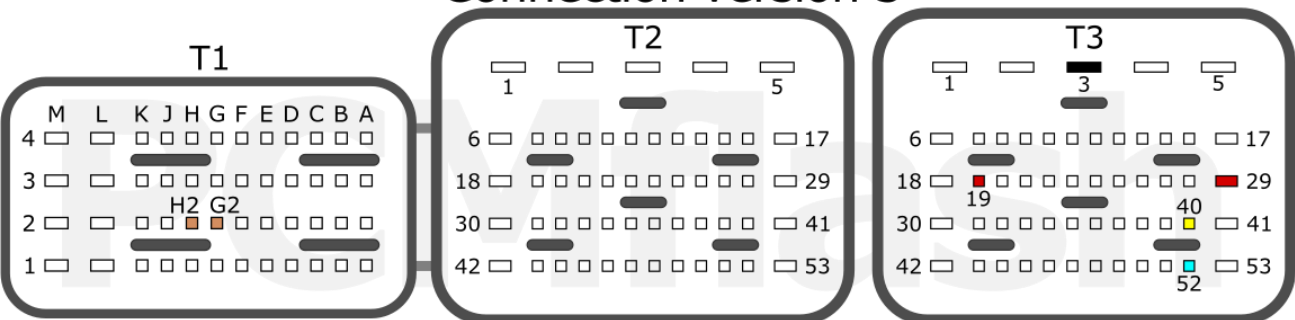

+12V	T3: 19, 29	CAN-L	T3: 52
GND	T3: 3	CAN-H	T3: 40
GPT	T1: H2; T1: G2		

PSA

pcmflash.ru

v.3

2024.04.10

PCMflash

Engine Control Unit

MED17.4.4 TC1793

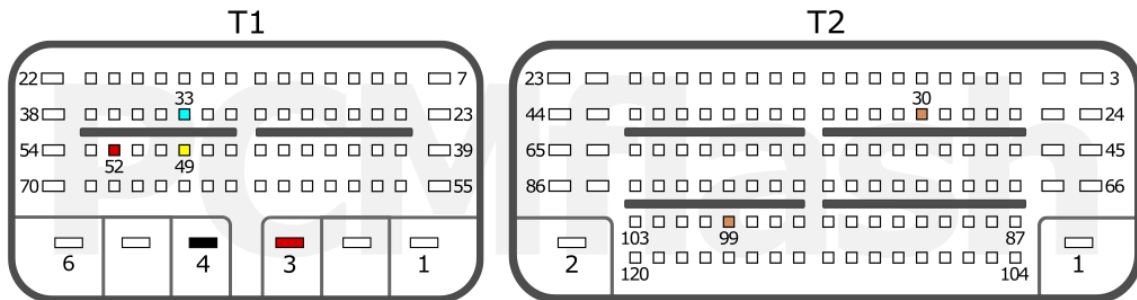

+12V	T1: 52, 3	CAN-L	T1: 33
GND	T1: 4	CAN-H	T1: 49
GPT	T2: 99, 30		

CITROEN

pcmflash.ru

v.1

2021-10-06

PCMflash

Engine Control Unit

MEVD17.4.4 TC1793

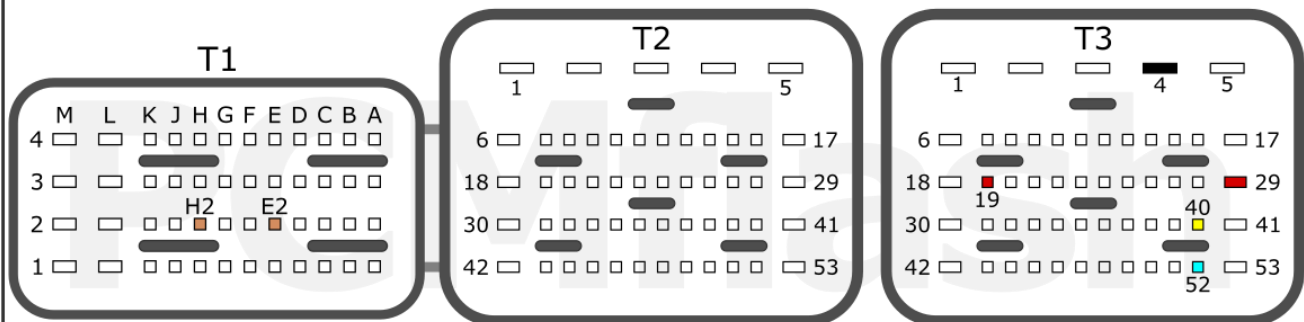

+12V	T3: 19, 29	CAN-L	T3: 52
GND	T3: 4	CAN-H	T3: 40
GPT	T1: H2, E2		

PSA

pcmflash.ru

v.1

2021-10-12

PCMflash

Engine Control Unit

ME(V)17.4.5 TC1796

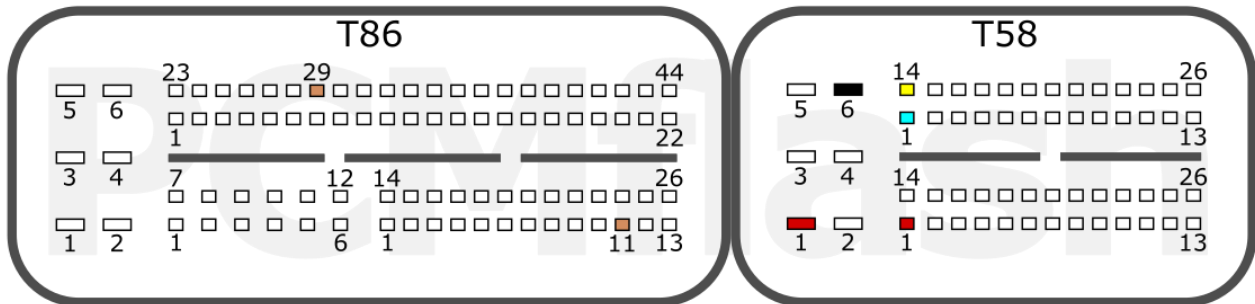

+12V	T58: 1, 1	CAN-L	T58: 1
GND	T58: 6	CAN-H	T58: 14
GPT	T86: 11, 29		

BMW

pcmflash.ru

v.2

2021-12-14

PCMflash

Engine Control Unit

MEV17.4.6 TC1796

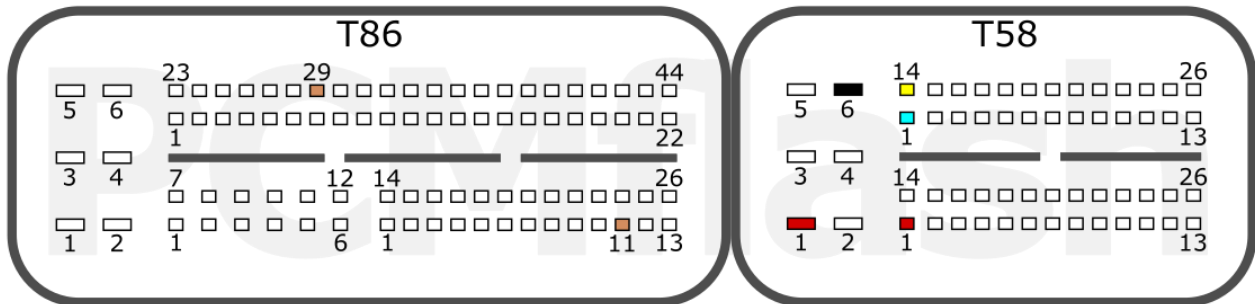

+12V	T58: 1, 1	CAN-L	T58: 1
GND	T58: 6	CAN-H	T58: 14
GPT	T86: 11, 29		

BMW

pcmflash.ru

v.2

2021-12-14

PCMflash

Engine Control Unit

ME17.5 TC1766

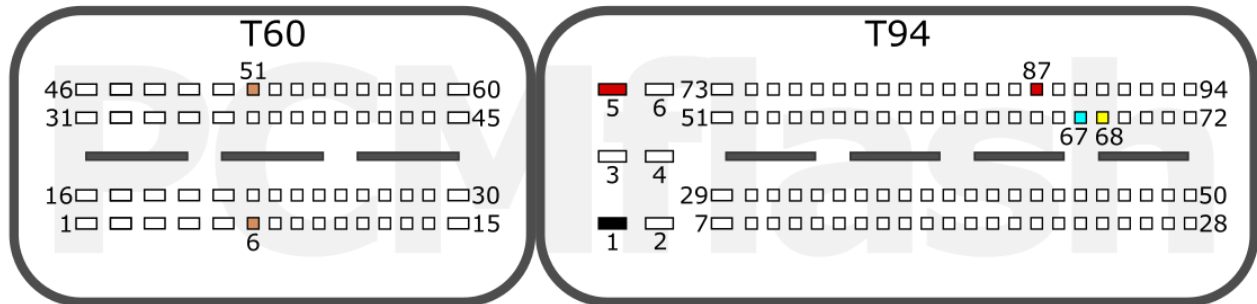

+12V	T94: 5, 87	CAN-L	T94: 67
GND	T94: 1	CAN-H	T94: 68
GPT	T60: 6, 51		

VAG

pcmflash.ru

v.1

2021-12-06

PCMflash

Engine Control Unit

MED17.5 TC1766

SKODA

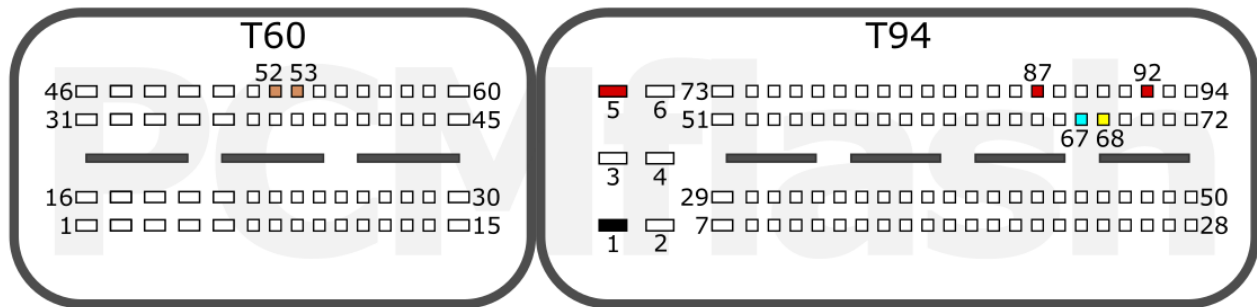

+12V	T94: 5, 87, 92	CAN-L	T94: 67
GND	T94: 1	CAN-H	T94: 68
GPT	T60: 52, 53		

VAG

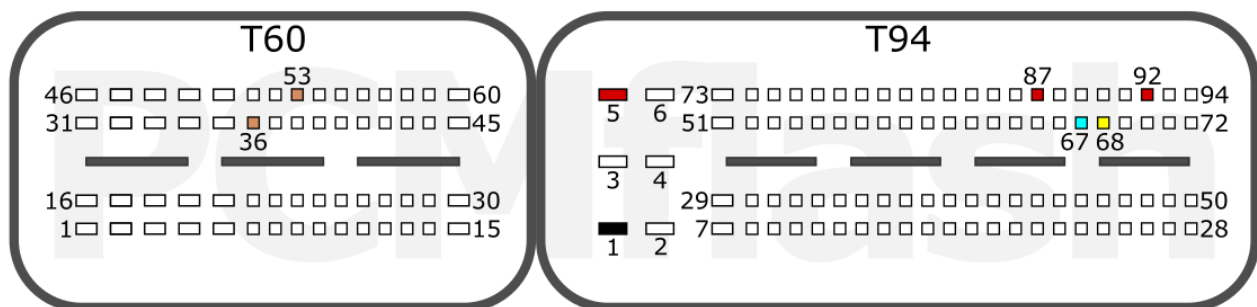

+12V	T94: 5, 87, 92	CAN-L	T94: 67
GND	T94: 1	CAN-H	T94: 68
GPT	T60: 53, 36		

SKODA

VAG

pcmflash.ru

v.2

2022-03-31

PCMflash

Engine Control Unit

MED17.5.1 TC1796

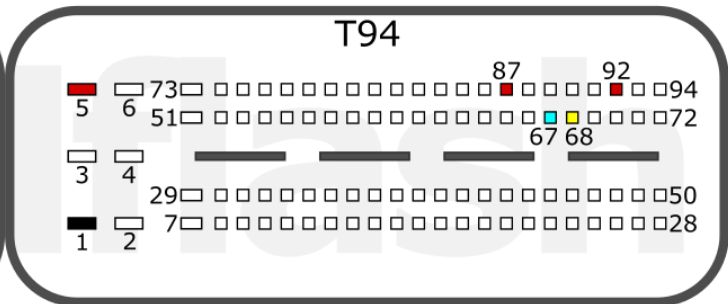

+12V	T94: 5, 87, 92	CAN-L	T94: 67
GND	T94: 1	CAN-H	T94: 68
GPT	T60: 36, 53		

VAG

pcmflash.ru

v.1

2021-10-11

PCMflash

Engine Control Unit

MED17.5.2 TC1767

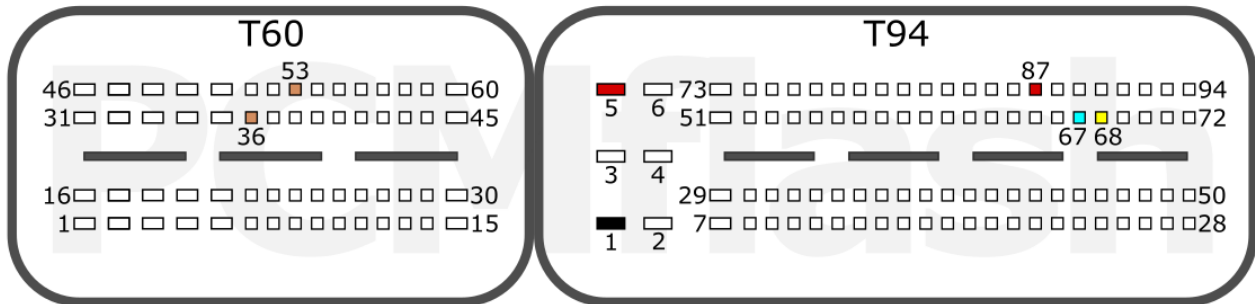

+12V	T94: 5, 87	CAN-L	T94: 67
GND	T94: 1	CAN-H	T94: 68
GPT	T60: 53, 36		

VAG

pcmflash.ru

v.1

2021-09-02

PCMflash

Engine Control Unit

MED17.5.5 TC1766

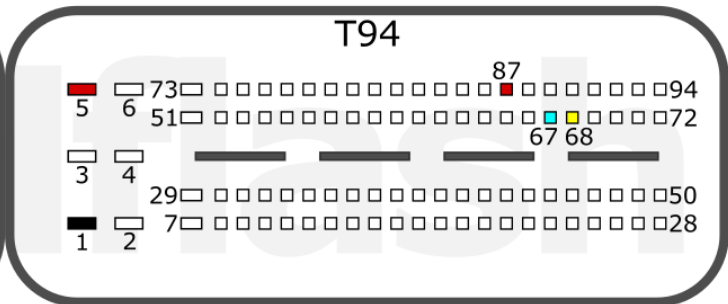
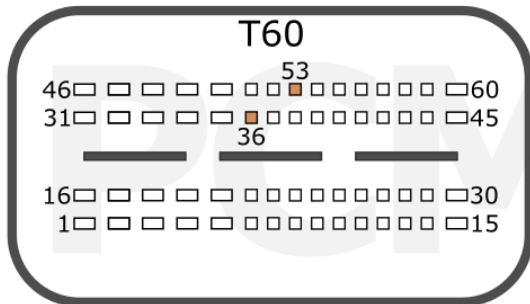

+12V	T94: 5, 87	CAN-L	T94: 67
GND	T94: 1	CAN-H	T94: 68
GPT	T60: 53, 36		

VAG

pcmflash.ru

v.1

2021-10-07

PCMflash

Engine Control Unit

ME17.5.6 TC1767

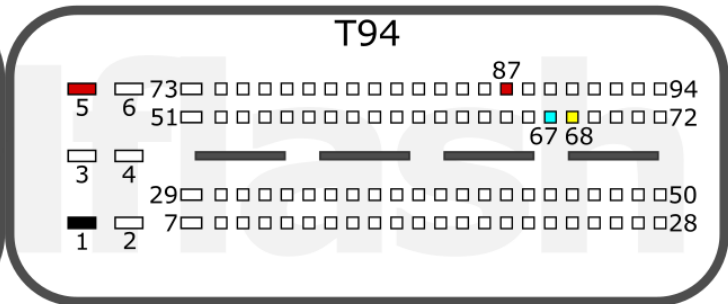
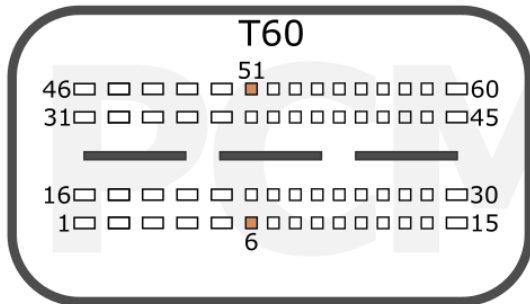

+12V	T94: 5, 87	CAN-L	T94: 67
GND	T94: 1	CAN-H	T94: 68
GPT	T60: 6, 51		

VAG

pcmflash.ru

v.2

2023-05-21

PCMflash

Engine Control Unit

MED17.5.20 TC1766

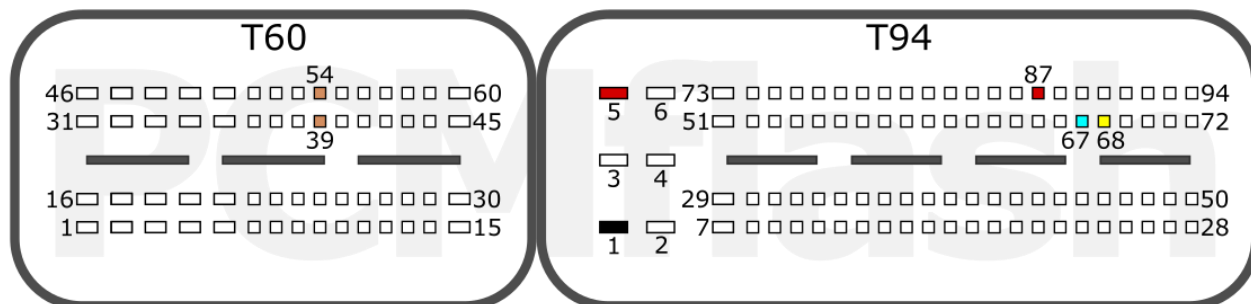

+12V	T94: 5, 87	CAN-L	T94: 67
GND	T94: 1	CAN-H	T94: 68
GPT	T60: 39, 54		

VAG

pcmflash.ru

v.1

2022-02-28

PCMflash

Engine Control Unit

MED17.5.21 TC1782

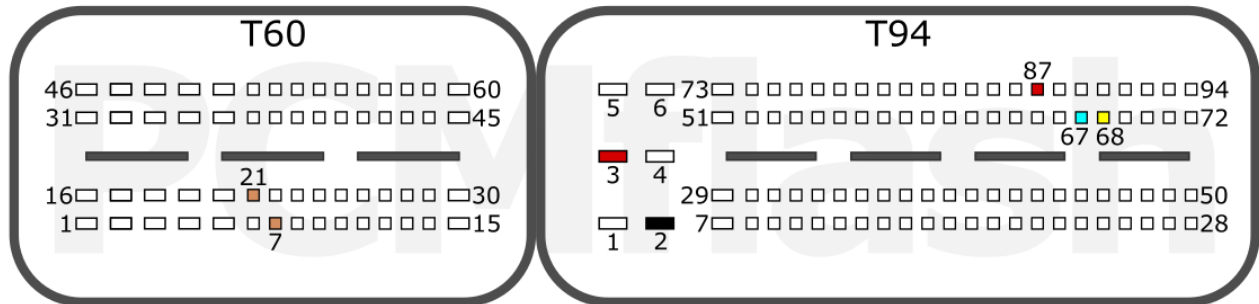

+12V	T94: 3, 87	CAN-L	T94: 67
GND	T94: 2	CAN-H	T94: 68
GPT	T60: 21, 7		

VAG

pcmflash.ru

v.1

2021-09-30

PCMflash

Engine Control Unit

MED17.5.25 TC1782

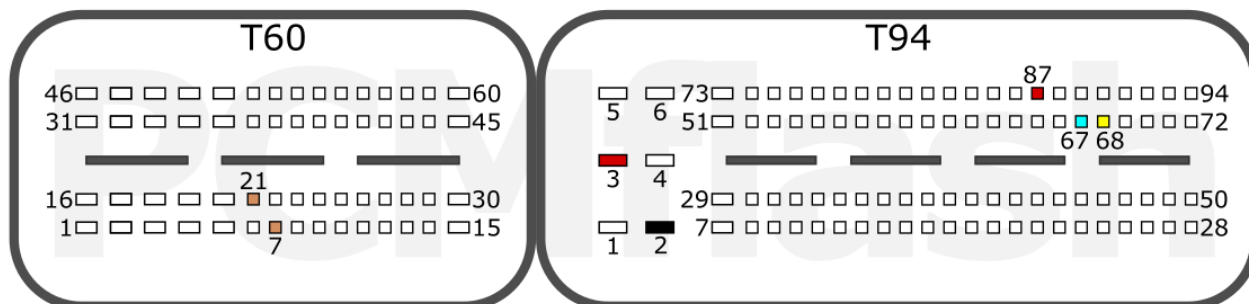

+12V	T94: 3, 87	CAN-L	T94: 67
GND	T94: 2	CAN-H	T94: 68
GPT	T60: 21, 7		

SKODA

pcmflash.ru

v.1

2021-09-26

PCMflash

Engine Control Unit

ME17.5.26 TC1724

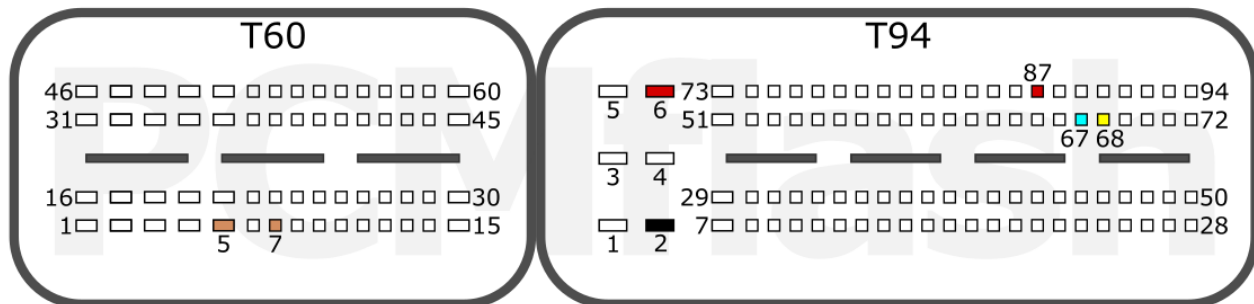

+12V	T94: 6, 87	CAN-L	T94: 67
GND	T94: 2	CAN-H	T94: 68
GPT	T60: 7, 5		

VAG

pcmflash.ru

v.1

2021-08-27

PCMflash

Engine Control Unit

ME17.7 TC1796

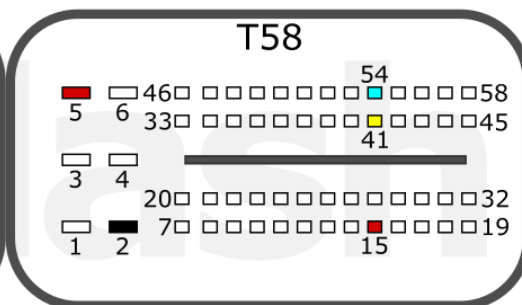
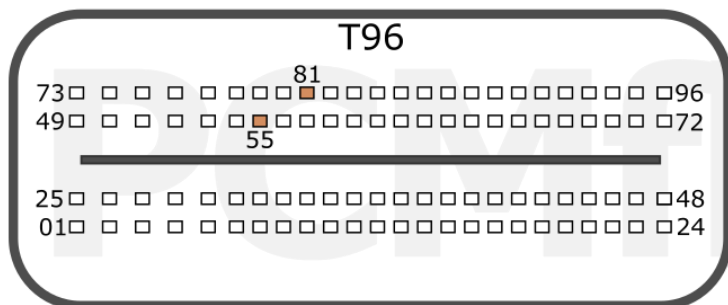

+12V	T58: 5, 15	CAN-L	T58: 54
GND	T58: 2	CAN-H	T58: 41
GPT	T96: 81, 55		

MB

pcmflash.ru

v.1

2021-10-13

PCMflash

Engine Control Unit

MED17.7.1 TC1797

Connection version 1

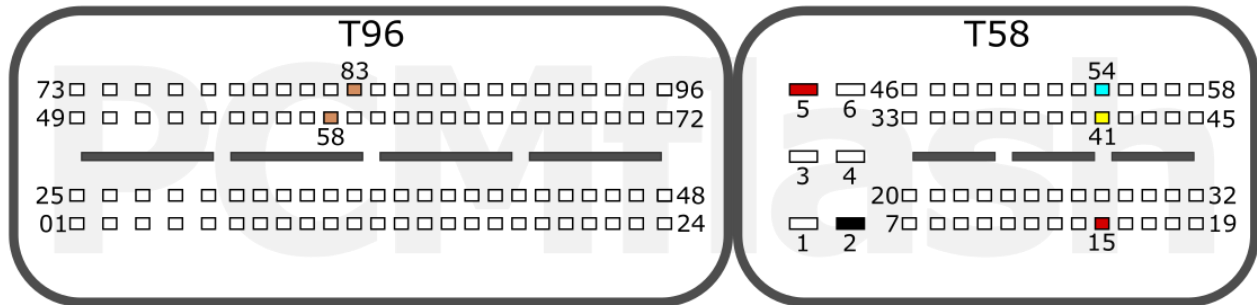

+12V	T58: 5, 15	CAN-L	T58: 54
GND	T58: 2	CAN-H	T58: 41
GPT	T96: 83, 58		

Connection version 2

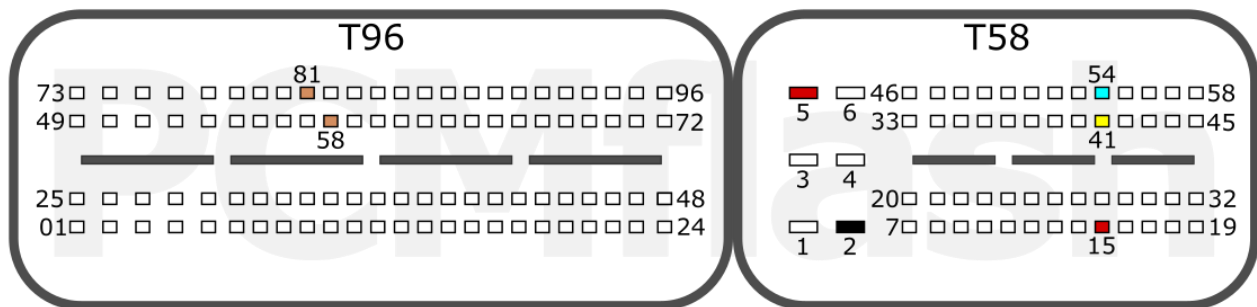

+12V	T58: 5, 15	CAN-L	T58: 54
GND	T58: 2	CAN-H	T58: 41
GPT	T96: 81, 58		

MB

pcmflash.ru

v.1

2021-11-01

PCMflash

Engine Control Unit
MED17.7.2 TC1797

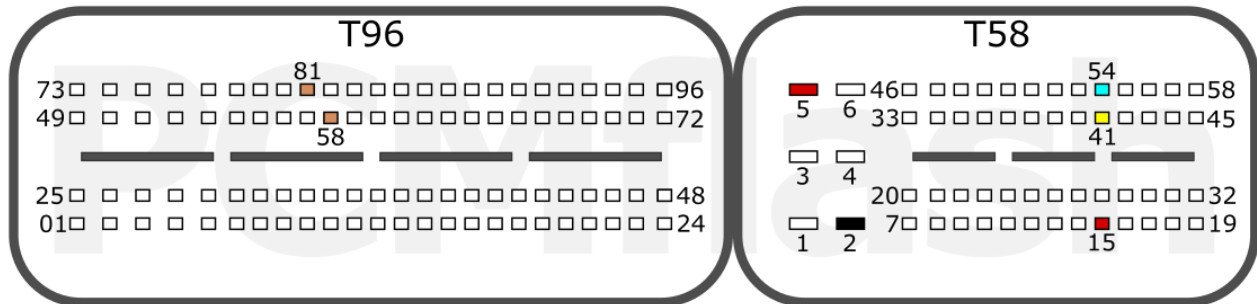

+12V	T58: 5, 15	CAN-L	T58: 54
GND	T58: 2	CAN-H	T58: 41
GPT	T96: 81, 58		

INFINITI

MB

pcmflash.ru

v.1

2021-09-08

PCMflash

Engine Control Unit

MED17.7.3 TC1797



+12V	T58: 5, 15	CAN-L	T58: 54
GND	T58: 2	CAN-H	T58: 41
GPT	T96: 83, 58		

MB

pcmflash.ru

v.1

2021-09-08

PCMflash

Engine Control Unit

MED17.7.3.1 TC1797



+12V	T58: 5, 15	CAN-L	T58: 54
GND	T58: 2	CAN-H	T58: 41
GPT	T96: 83, 58		

MB

pcmflash.ru

v.1

2021-11-01

PCMflash

Engine Control Unit

MED17.7.5 TC1793

T105

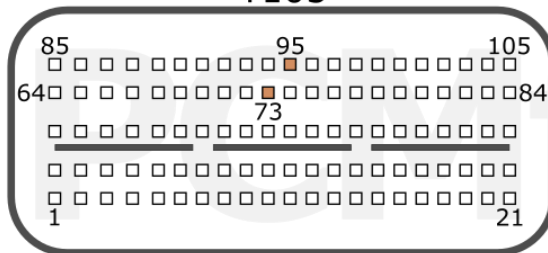

T91

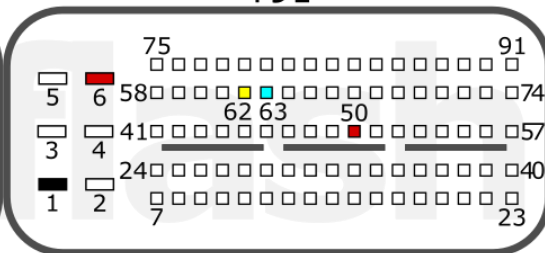

+12V	T91: 6, 50	CAN-L	T91: 63
GND	T91: 1	CAN-H	T91: 62
GPT	T105: 73, 95		

MB

pcmflash.ru

v.1

2021-10-06

PCMflash

Engine Control Unit

MED17.7.7 TC1793

Connection version 1



+12V	T58: 3, 15, 16	CAN-L	T58: 54
GND	T58: 4	CAN-H	T58: 41
GPT	T96: 58, 82		

Connection version 2

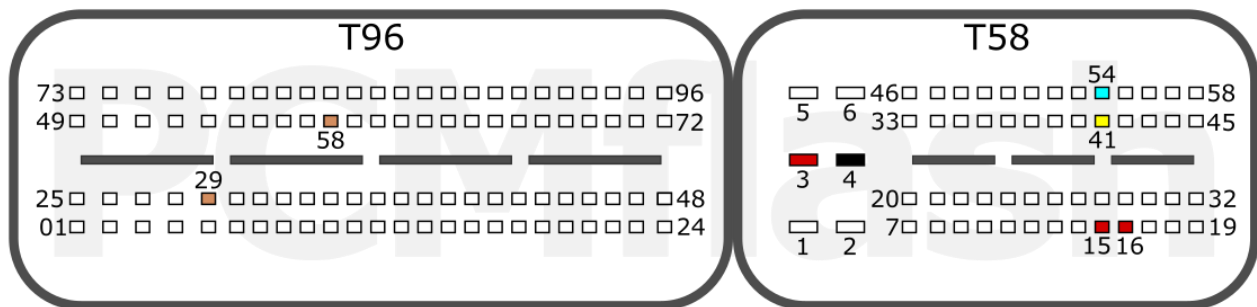

+12V	T58: 3, 15, 16	CAN-L	T58: 54
GND	T58: 4	CAN-H	T58: 41
GPT	T96: 29, 58		

MB

pcmflash.ru

v.1

2021-09-10

PCMflash

Engine Control Unit

MED17.8.2 TC1767

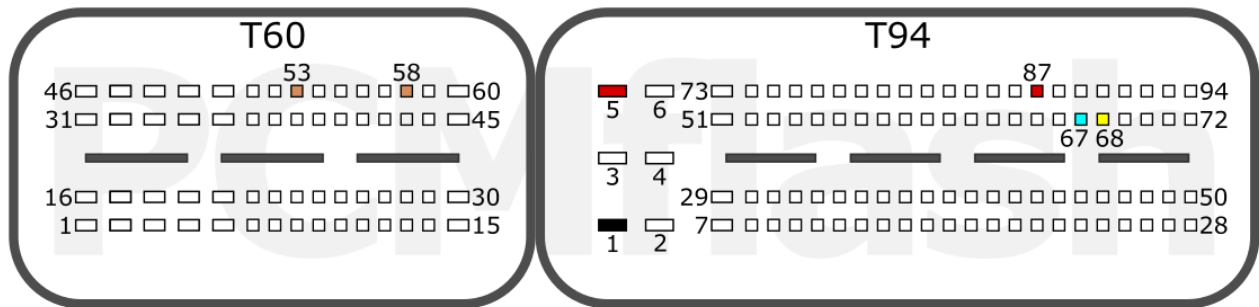

+12V	T94: 5, 87	CAN-L	T94: 67
GND	T94: 1	CAN-H	T94: 68
GPT	T60: 53, 58		

GEELY

pcmflash.ru

v.1

2021-11-01

PCMflash

Engine Control Unit

MEVD17.8.4 TC1797

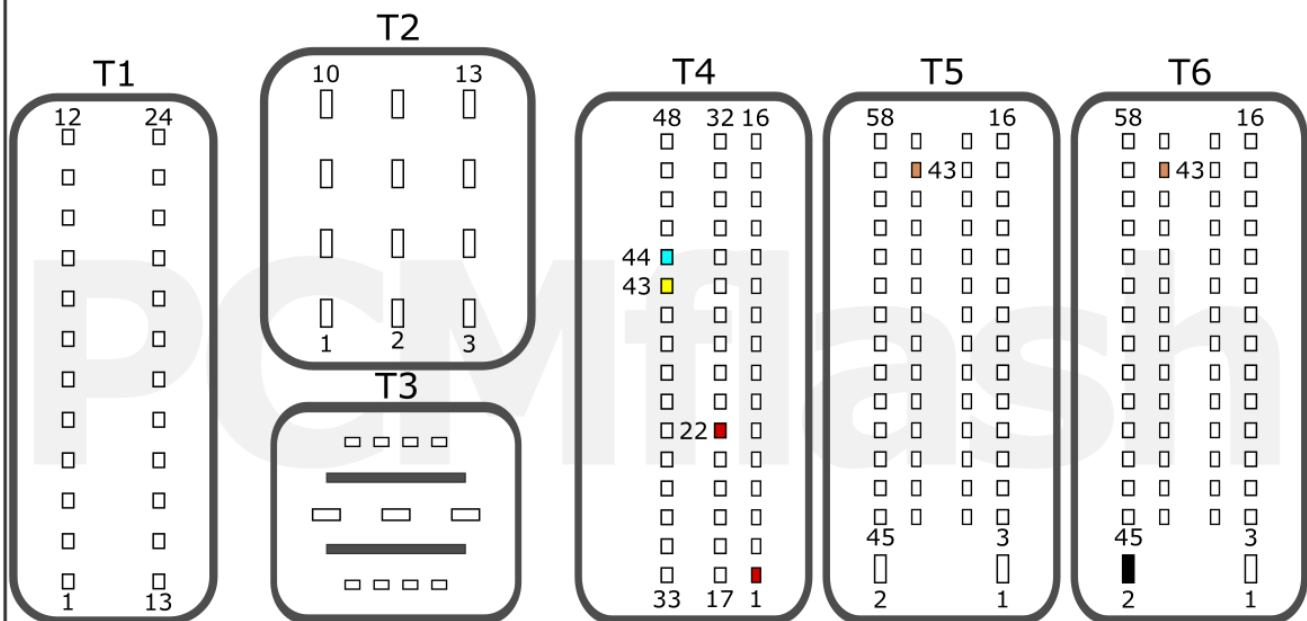

+12V	T4: 1, 22	CAN-L	T4: 44
GND	T6: 2	CAN-H	T4: 43
GPT	T5: 43, T6: 43		

BMW

pcmflash.ru

v.1

2021-11-01

PCMflash

Engine Control Unit

ME17.8.5 TC1762

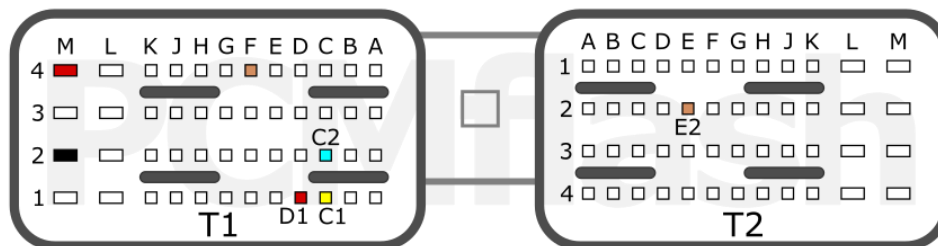

+12V	T1: M4, D1	CAN-L	T1: C2
GND	T1: M2	CAN-H	T1: C1
GPT	T1: F4, T2:E2		

ROTAX

pcmflash.ru

v.1

2021-09-28

PCMflash

Engine Control Unit

M17.8.7 TC1762

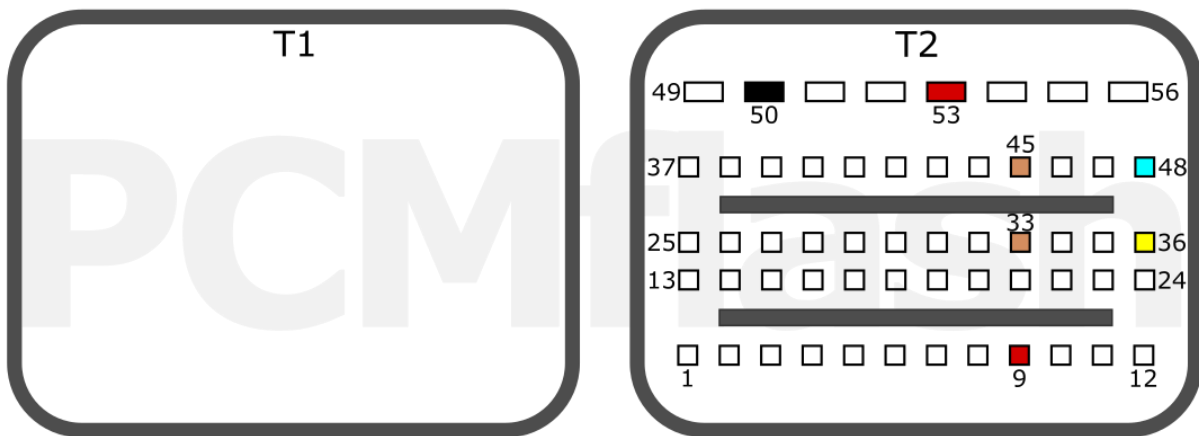

+12V	T2: 53, 9	CAN-L	T2: 48
GND	T2: 50	CAN-H	T2: 36
GPT	T2: 45, 33		

POLARIS ATV

pcmflash.ru

v.1

2021-12-09

PCMflash

Engine Control Unit

ME17.8.8/ME17.8.8.1/ME17U6 TC1728/TC1782

Connection version 1



+12V	T1: 20, 35	CAN-L	T1: 17
GND	T1: 64	CAN-H	T1: 1
GPT*	T2: 93, 96		

*Select "Use other GPT output pins" in the pcmflash settings or set GPT to EXT in case powerbox for PCMflash is used /
При использовании powerbox for PCMflash выбрать режим GPT EXT или использовать альтернативные пины

Connection version 2



+12V	T1: 20, 35	CAN-L	T1: 3
GND	T1: 64	CAN-H	T1: 4
GPT*	T2: 93, 96		

*Select "Use other GPT output pins" in the pcmflash settings or set GPT to EXT in case powerbox for PCMflash is used /
При использовании powerbox for PCMflash выбрать режим GPT EXT или использовать альтернативные пины

CHINA

pcmflash.ru

v.1

2023-07-01

PCMflash

Engine Control Unit

MED17.8.10 TC1728/TC1782

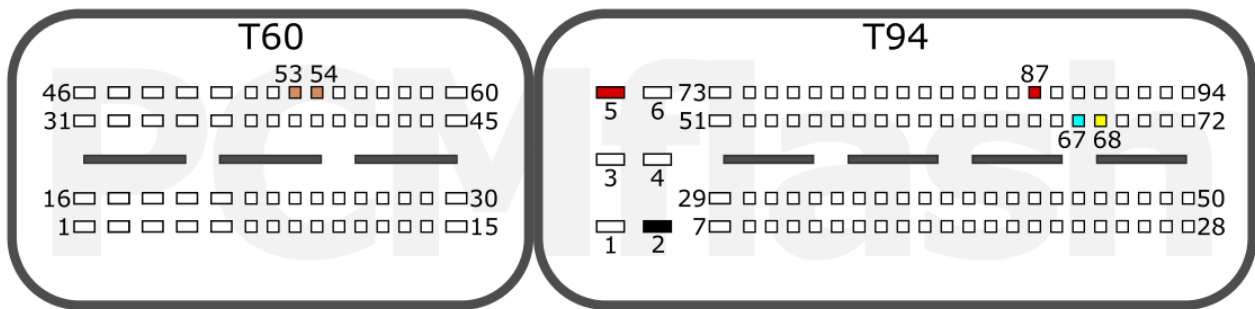

+12V	T94: 5, 87	CAN-L	T94: 67
GND	T94: 2	CAN-H	T94: 68
GPT	T60: 53, 54		

CHINA

pcmflash.ru

v.2

2023-07-30

PCMflash

Engine Control Unit

MED17.8.21 TC1767

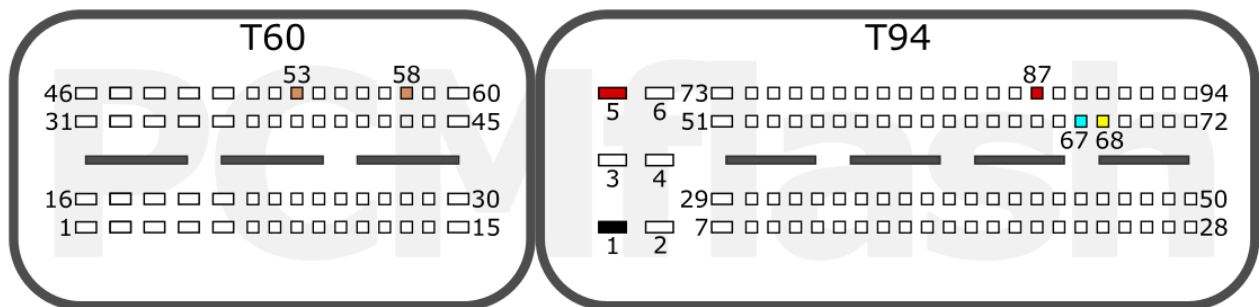

+12V	T94: 5, 87	CAN-L	T94: 67
GND	T94: 1	CAN-H	T94: 68
GPT	T60: 53, 58		

FOTON

pcmflash.ru

v.1

2021-10-31

PCMflash

Engine Control Unit

MED17.8.31 TC1797

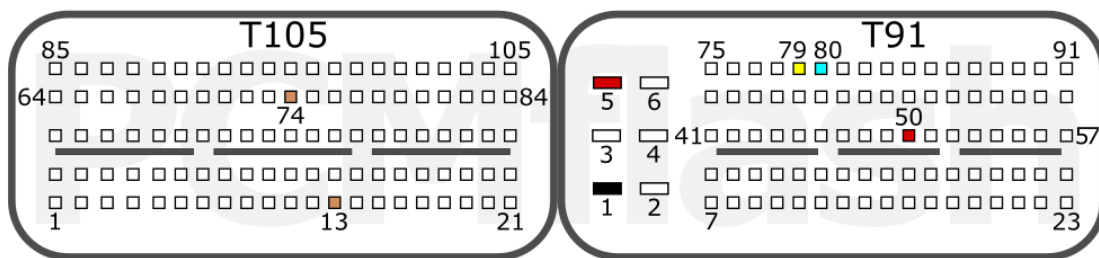

+12V	T91: 5, 50	CAN-L	T91: 80
GND	T91: 1	CAN-H	T91: 79
GPT	T105: 13, 74		

JLR

pcmflash.ru

v.1

2021-09-11

PCMflash

Engine Control Unit

ME17.8.32 TC1797

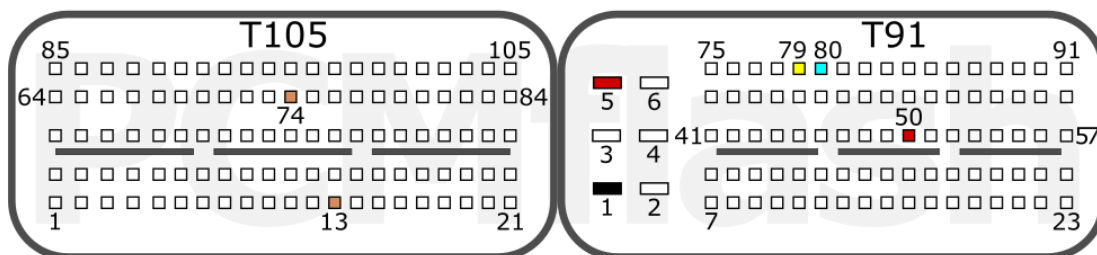

+12V	T91: 5, 50	CAN-L	T91: 80
GND	T91: 1	CAN-H	T91: 79
GPT	T105: 74, 13		

MCLAREN

pcmflash.ru

v.1

2021-10-14

PCMflash

Engine Control Unit

MED17.8.32 TC1793

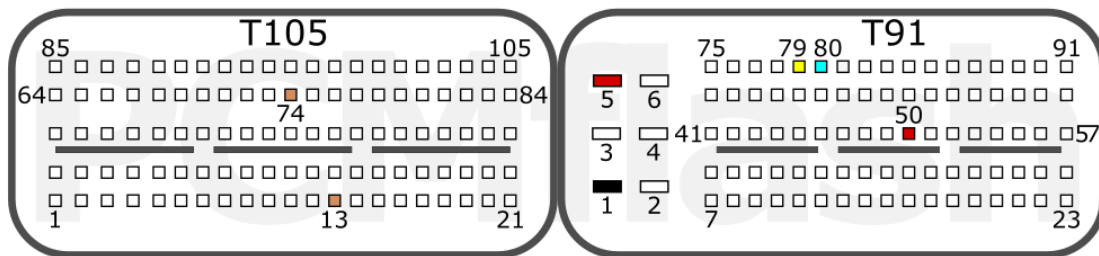

+12V	T91: 5, 50	CAN-L	T91: 80
GND	T91: 1	CAN-H	T91: 79
GPT	T105: 13, 74		

JLR

pcmflash.ru

v.1

2021-10-12

PCMflash

Engine Control Unit

MED17.8.34 TC1793

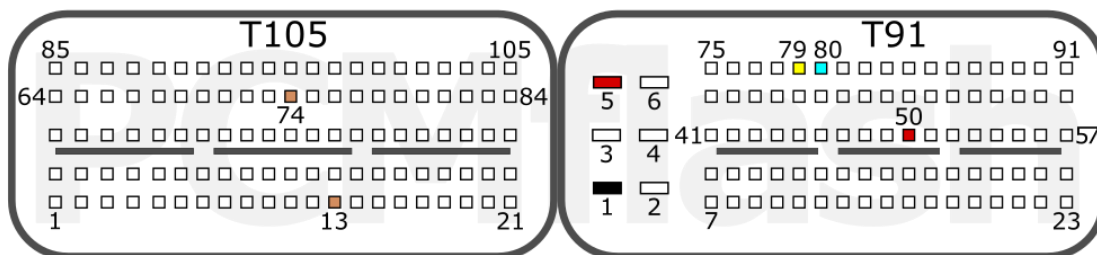

+12V	T91: 5, 50	CAN-L	T91: 80
GND	T91: 1	CAN-H	T91: 79
GPT	T105: 13, 74		

AURUS

pcmflash.ru

v.1

2023-08-03

PCMflash

Engine Control Unit

MEDC17.9 TC1793

T105

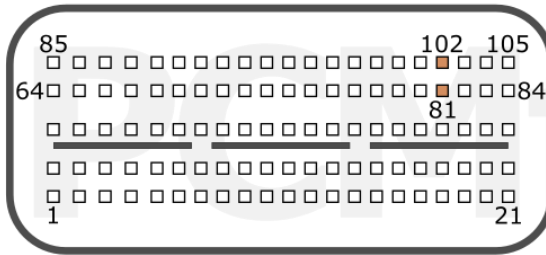

T91

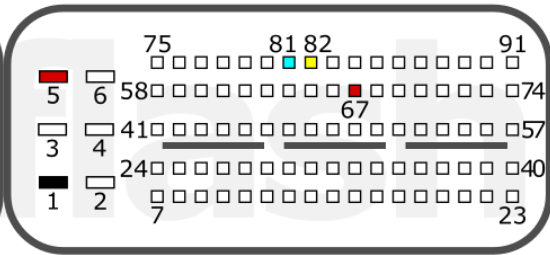

+12V	T91: 5, 67	CAN-L	T91: 81
GND	T91: 1	CAN-H	T91: 82
GPT	T105: 81, 102		

JLR

pcmflash.ru

v.1

2021-10-09

PCMflash

Engine Control Unit

MEG17.9.2 TC1767

T105



T91

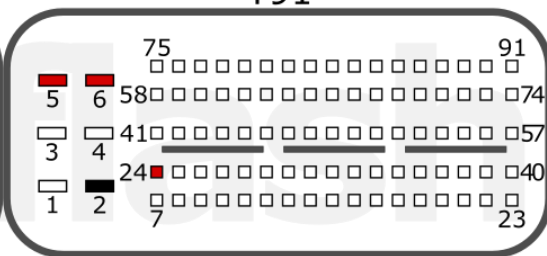

+12V	T91: 5, 6, 24	CAN-L	T105: 81
GND	T91: 2	CAN-H	T105: 102
GPT	T105: 54, 73		

K/H

pcmflash.ru

v.1

2022-03-04

PCMflash

Engine Control Unit

MED17.9.3 TC1793

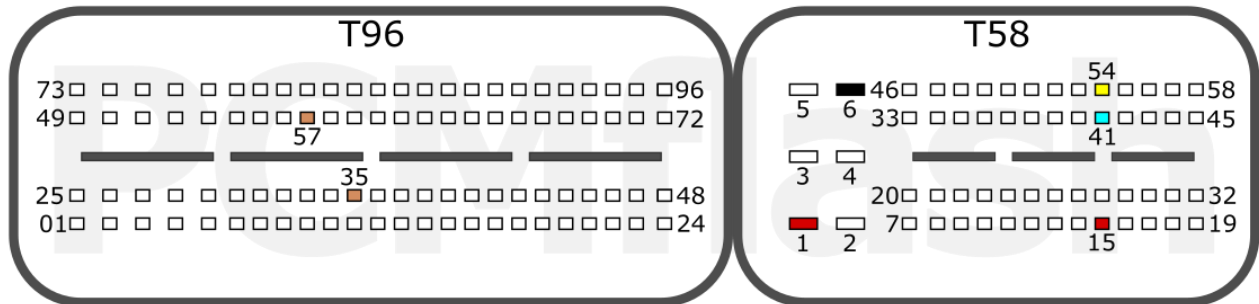

+12V	T58: 1, 15	CAN-L	T58: 41
GND	T58: 6	CAN-H	T58: 54
GPT	T96: 35, 57		

HONDA

PCMflash

Engine Control Unit

ME17.9.6 TC1767

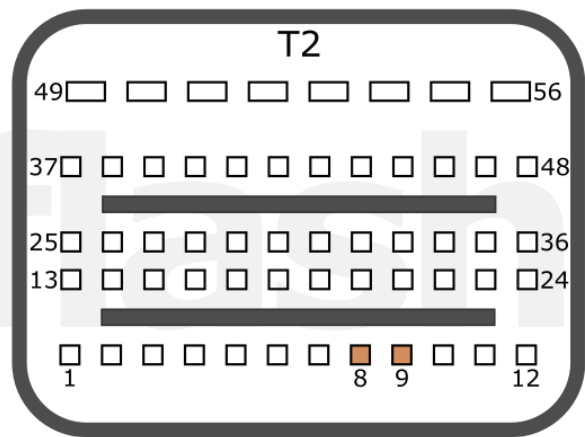
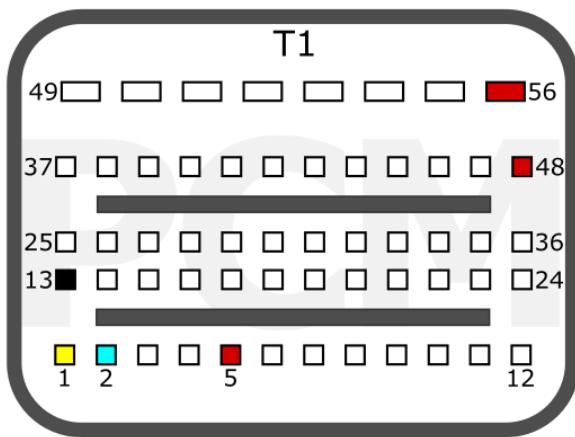

+12V	T1: 56, 48, 5	CAN-L	T1: 2
GND	T1: 13	CAN-H	T1: 1
GPT	T2: 8, 9		

SUZUKI

pcmflash.ru

v.1

2021-10-10

PCMflash

Engine Control Unit

ME17.9.7 TC1762

UAZ

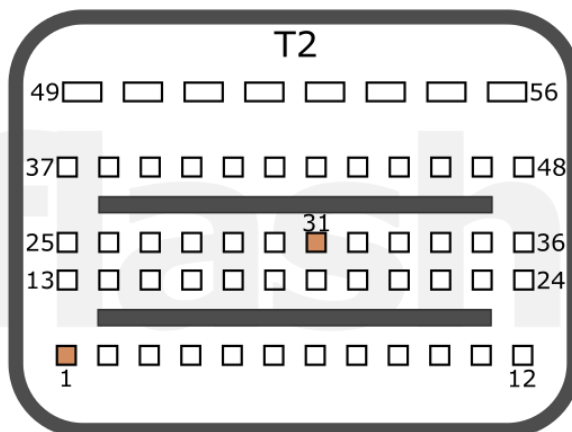
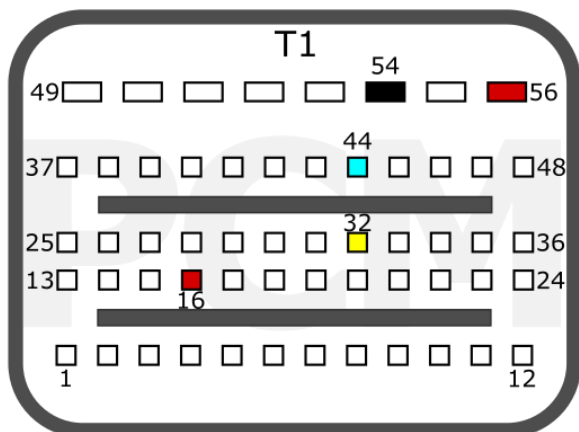

+12V	T1: 56, 16	CAN-L	T1: 44
GND	T1: 54	CAN-H	T1: 32
GPT	T2: 1, 31		

VAZ

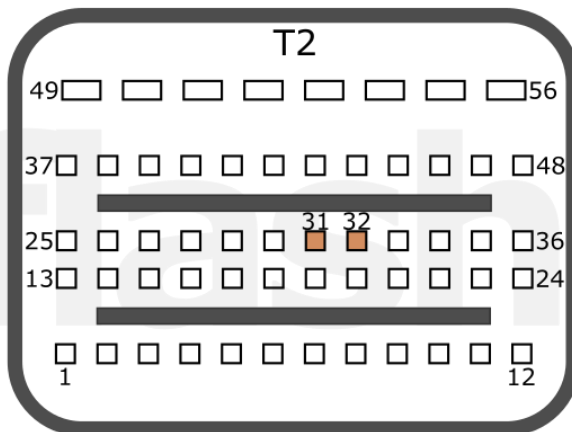
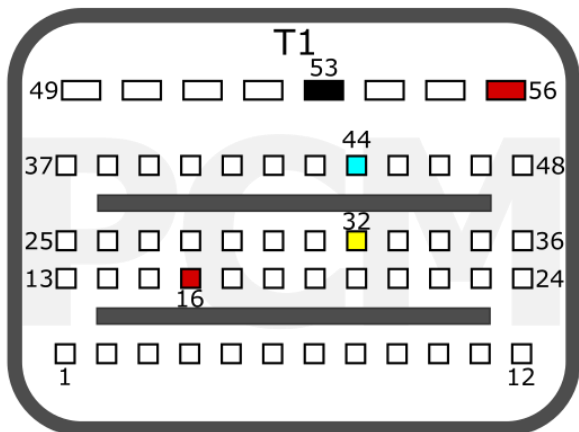

+12V	T1: 56, 16	CAN-L	T1: 44
GND	T1: 53	CAN-H	T1: 32
GPT	T2: 32, 31		

VAZ

UAZ

pcmflash.ru

v.1

2021-09-03

PCMflash

Engine Control Unit

MED17.9.7 TC1767

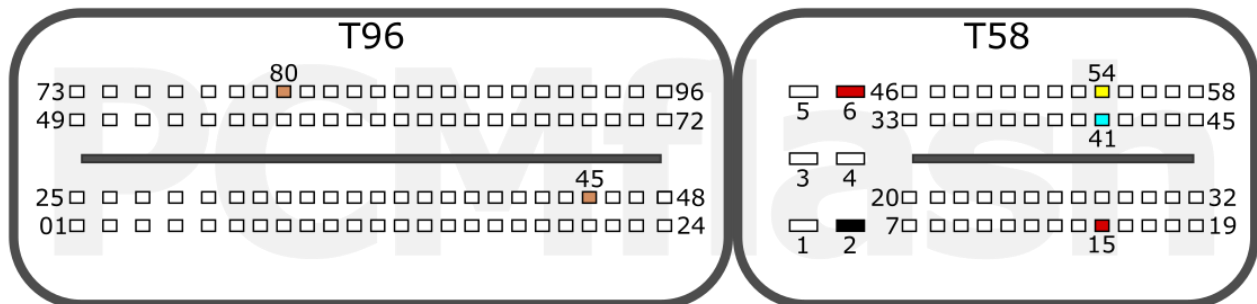

+12V	T58: 6, 15	CAN-L	T58: 41
GND	T58: 2	CAN-H	T58: 54
GPT	T96: 80, 45		

JLR

pcmflash.ru

v.1

2021-09-27

PCMflash

Engine Control Unit

ME(D)17.9.8 TC1767

Connection version 1

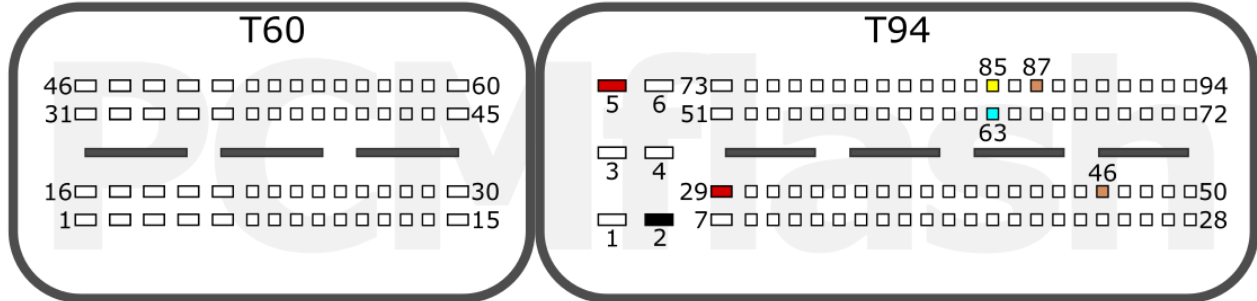

+12V	T94: 5, 29	CAN-L	T94: 63
GND	T94: 2	CAN-H	T94: 85
GPT	T94: 46, 87		

Connection version 2

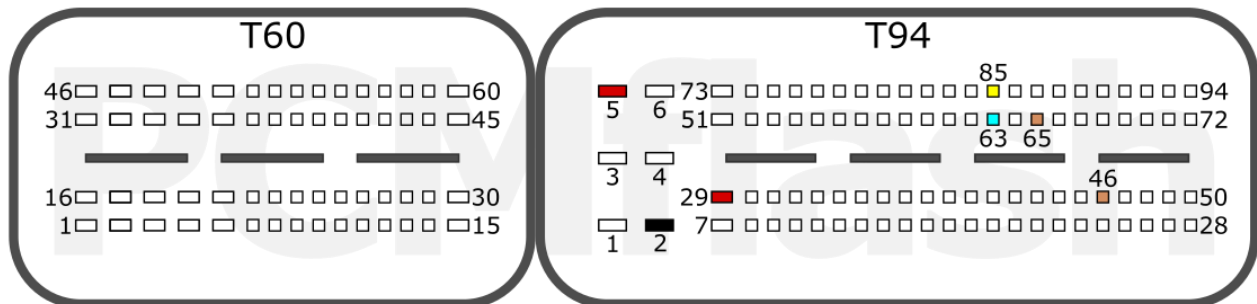

+12V	T94: 5, 29	CAN-L	T94: 63
GND	T94: 2	CAN-H	T94: 85
GPT	T94: 46, 65		

Connection version 3

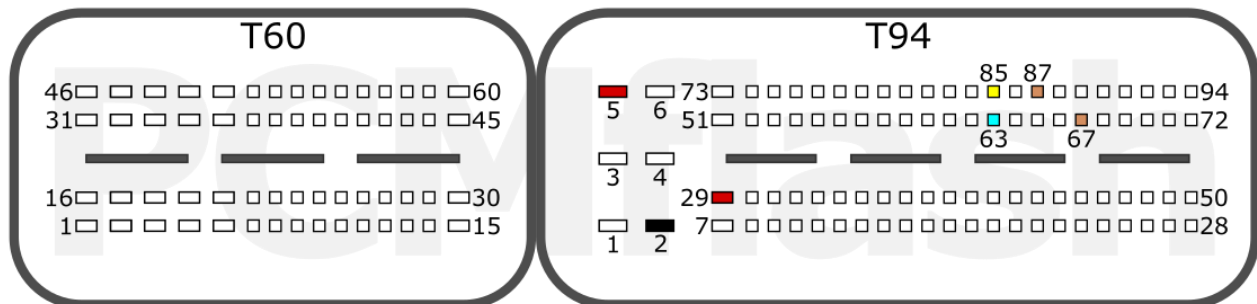

+12V	T94: 5, 29	CAN-L	T94: 63
GND	T94: 2	CAN-H	T94: 85
GPT	T94: 67, 87		

K/H

PCMflash

Engine Control Unit

MEG17.9.8 TC1767

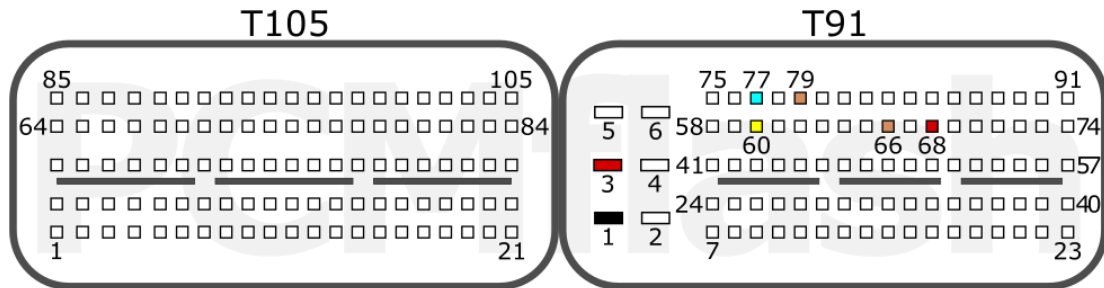

+12V	T91: 3, 68	CAN-L	T91: 77
GND	T91: 1	CAN-H	T91: 60
GPT	T91: 66, 79		

K/H

pcmflash.ru

v.1

2021-10-15

PCMflash

Engine Control Unit

MEDG17.9.8 TC1767

Connection version 1

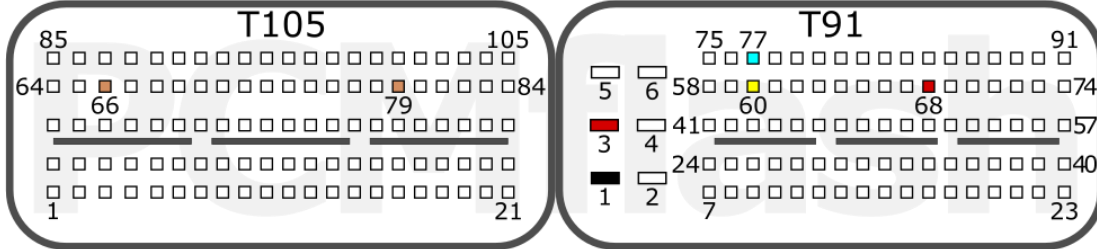

+12V	T91: 3, 68	CAN-L	T91: 77
GND	T91: 1	CAN-H	T91: 60
GPT	T105: 66, 79		

Connection version 2

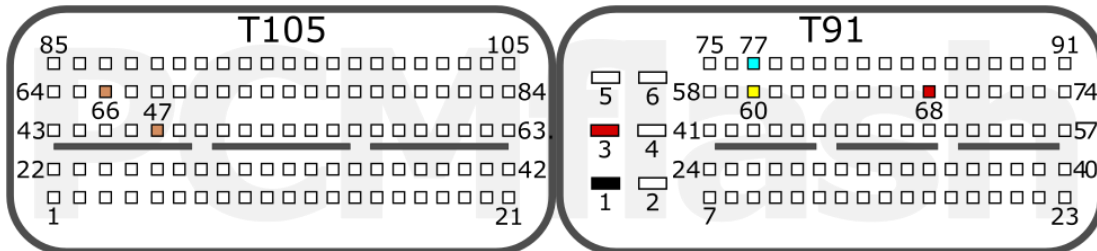

+12V	T91: 3, 68	CAN-L	T91: 77
GND	T91: 1	CAN-H	T91: 60
GPT	T105: 66, 47		

Connection version 3

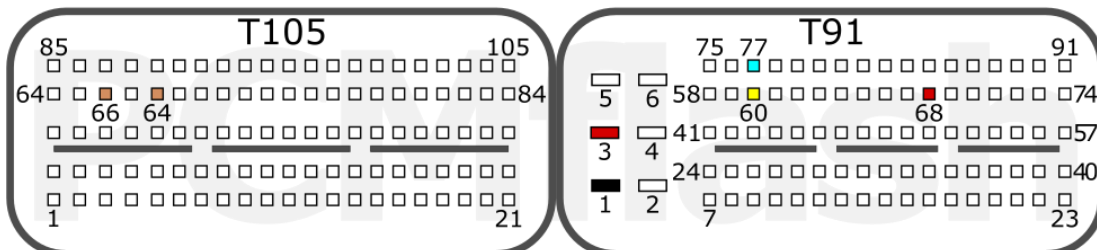

+12V	T91: 3, 68	CAN-L	T91: 77
GND	T91: 1	CAN-H	T91: 60
GPT	T105: 66, 64		

K/H

PCMflash

Engine Control Unit

MED17.9.9 TC1793

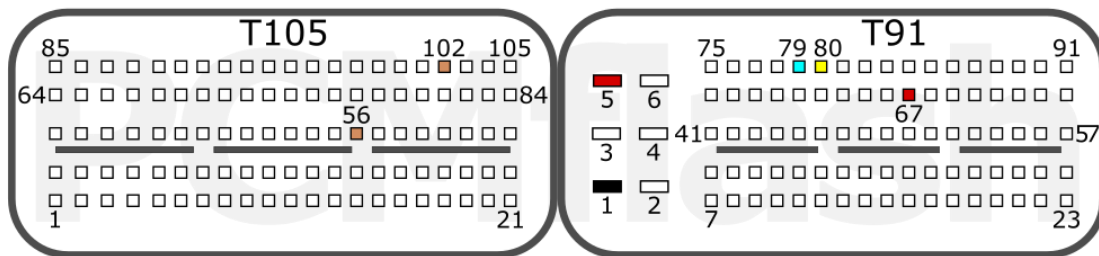

+12V	T91: 5, 67	CAN-L	T91: 79
GND	T91: 1	CAN-H	T91: 80
GPT	T105: 56, 102		

JLR

pcmflash.ru

v.1

2021-09-11

PCMflash

Engine Control Unit

M17.9.11 TC1762

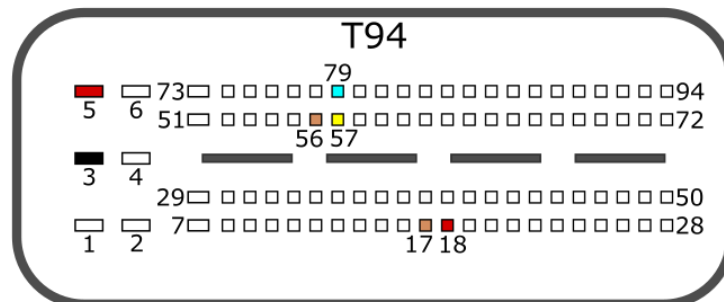

+12V	T94: 5, 18	CAN-L	T94: 79
GND	T94: 3	CAN-H	T94: 57
GPT	T94: 17, 56		

K/H

pcmflash.ru

v.1

2024-06-02

PCMflash

Engine Control Unit

ME17.9.11 TC1762

Connection version 1

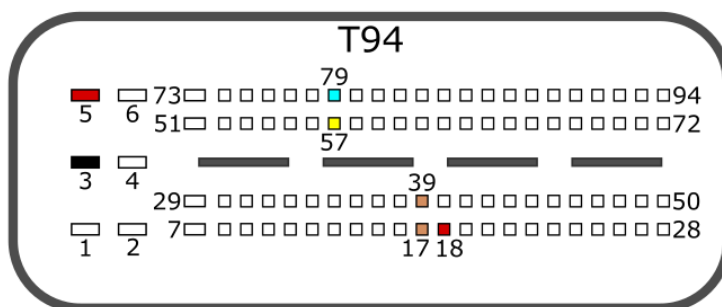

+12V	T94: 5, 18	CAN-L	T94: 79
GND	T94: 3	CAN-H	T94: 57
GPT	T94: 17, 39		

Connection version 2

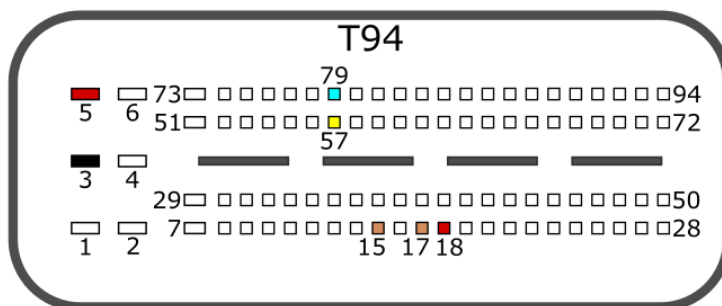

+12V	T94: 5, 18	CAN-L	T94: 79
GND	T94: 3	CAN-H	T94: 57
GPT	T94: 17, 15		

K/H

PCMflash

Engine Control Unit

MEG17.9.12/17.9.13 TC1762

Connection version 1

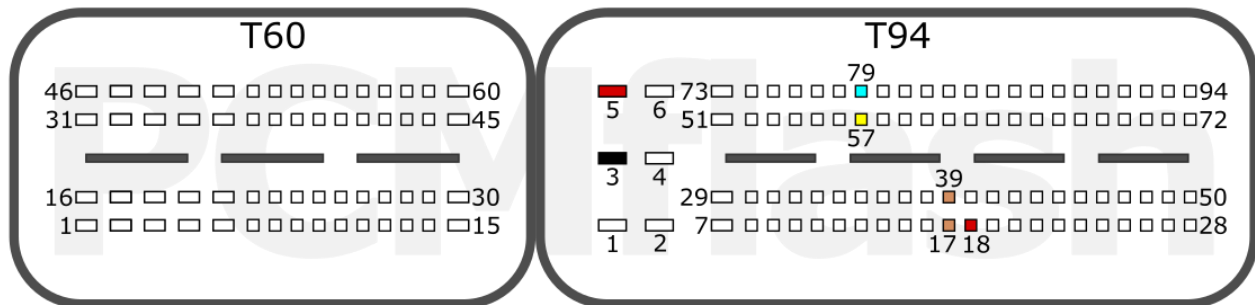

+12V	T94: 5, 18	CAN-L	T94: 79
GND	T94: 3	CAN-H	T94: 57
GPT	T94: 17, 39		

Connection version 2

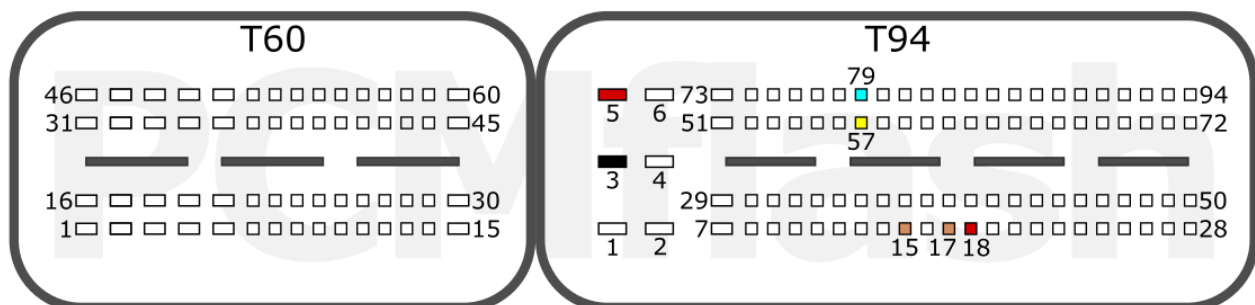

+12V	T94: 5, 18	CAN-L	T94: 79
GND	T94: 3	CAN-H	T94: 57
GPT	T94: 17, 15		

K/H

pcmflash.ru

v.2

2023-12-08

PCMflash

Engine Control Unit

ME17.9.20 TC1782

BRABUS, SMART

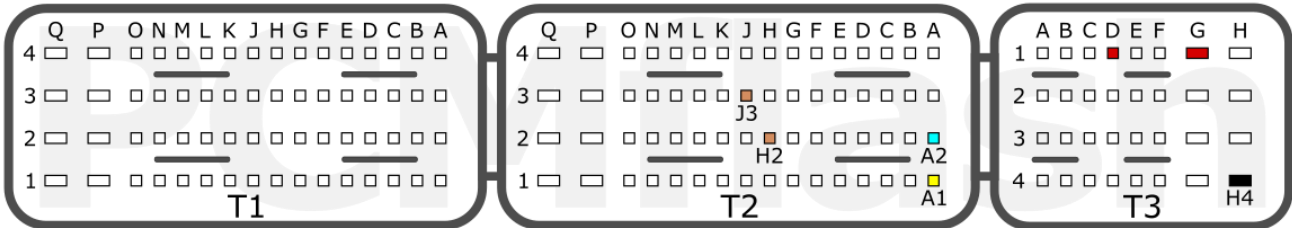

+12V	T3: D1, G1	CAN-L	T2: A2
GND	T3: H4	CAN-H	T2: A1
GPT	T2: H2, J3		

RENAULT

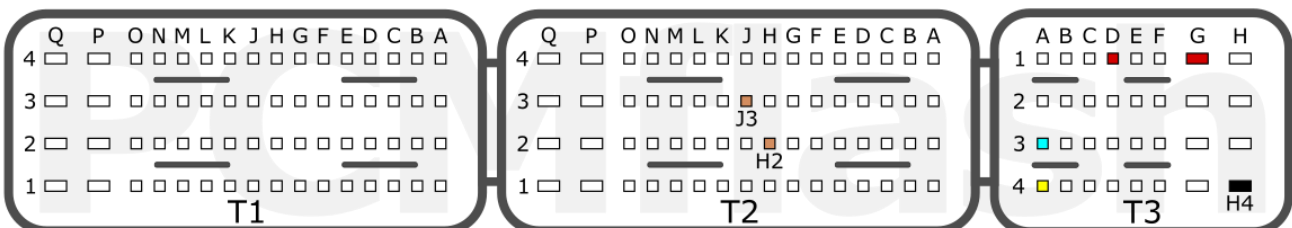

+12V	T3: D1, G1	CAN-L	T3: A3
GND	T3: H4	CAN-H	T3: A4
GPT	T2: H2, J3		

BRABUS

RENAULT

SMART

pcmflash.ru

v.1

2021-10-31

PCMflash

Engine Control Unit

MEG17.9.21 TC1724

Connection version 1

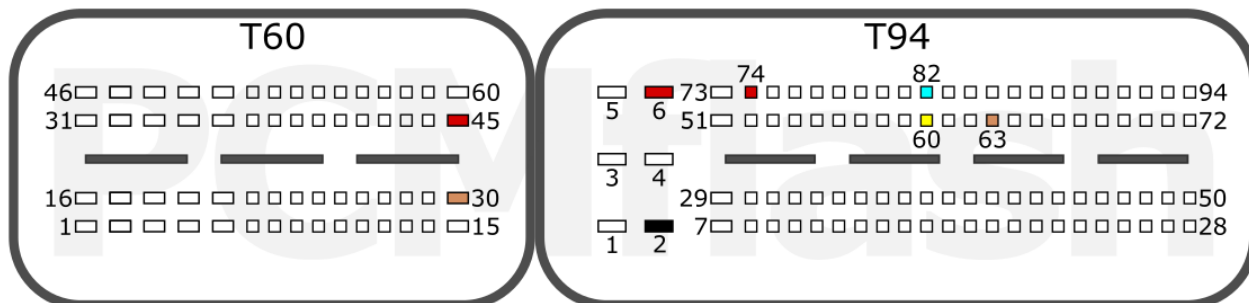

+12V	T60: 45, T94: 6, 74	CAN-L	T94: 82
GND	T94: 2	CAN-H	T94: 60
GPT	T60: 30, T94: 63		

Connection version 2

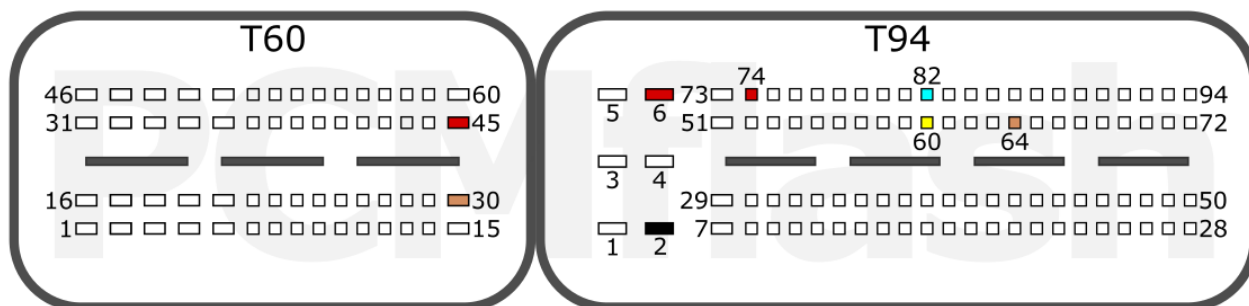

+12V	T60: 45, T94: 6, 74	CAN-L	T94: 82
GND	T94: 2	CAN-H	T94: 60
GPT	T60: 30, T94: 64		

Connection version 3

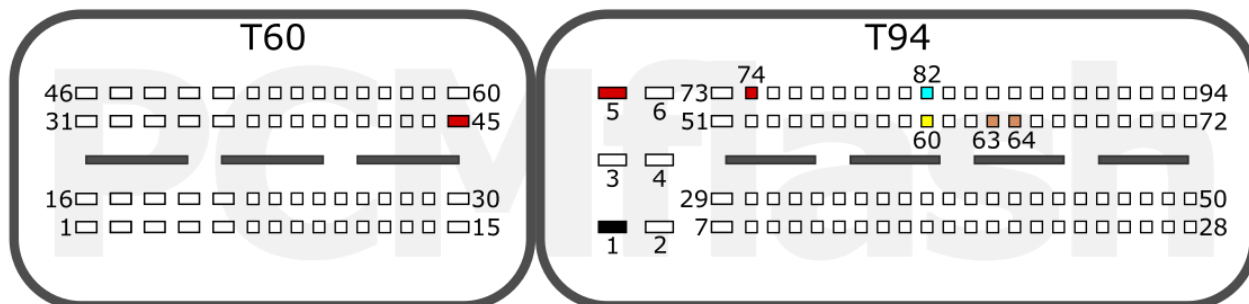

+12V	T60: 45, T94: 5, 74	CAN-L	T94: 82
GND	T94: 1	CAN-H	T94: 60
GPT	T94: 63, 64		

K/H

PCMflash

Engine Control Unit

ME17.9.21.1 TC1724

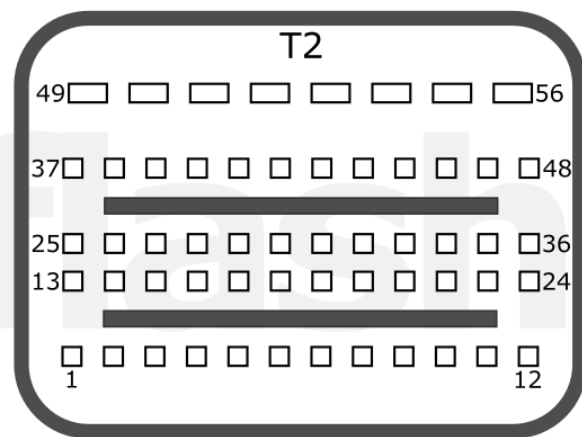
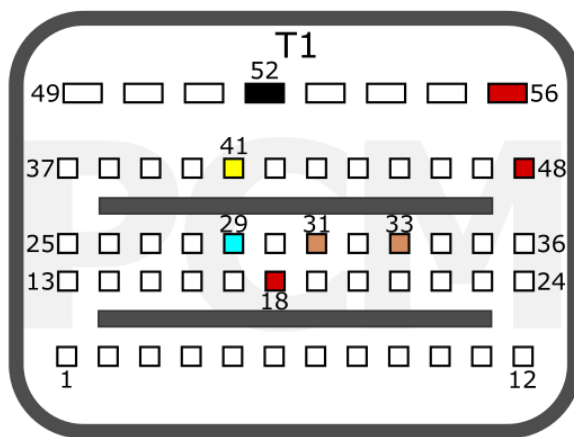

+12V	T1: 56, 48, 18	CAN-L	T1: 29
GND	T1: 52	CAN-H	T1: 41
GPT	T1: 31, 33		

K/H

pcmflash.ru

v.2

2023-12-16

PCMflash

Engine Control Unit

MED17.9.30 TC1793

Connection version 1

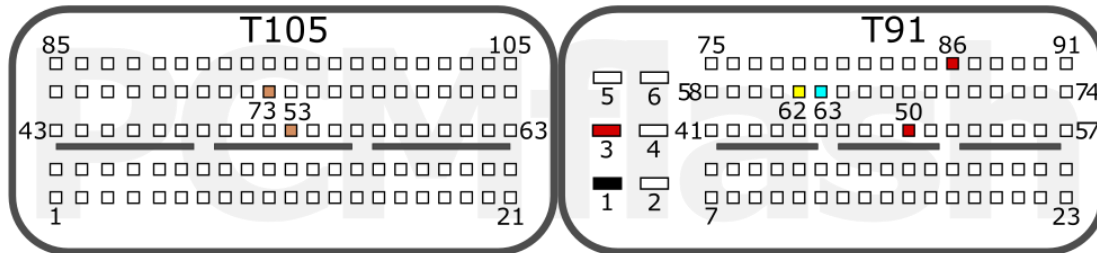

+12V	T91: 3, 50, 86	CAN-L	T91: 63
GND	T91: 1	CAN-H	T91: 62
GPT	T105: 73, 53		

Connection version 2

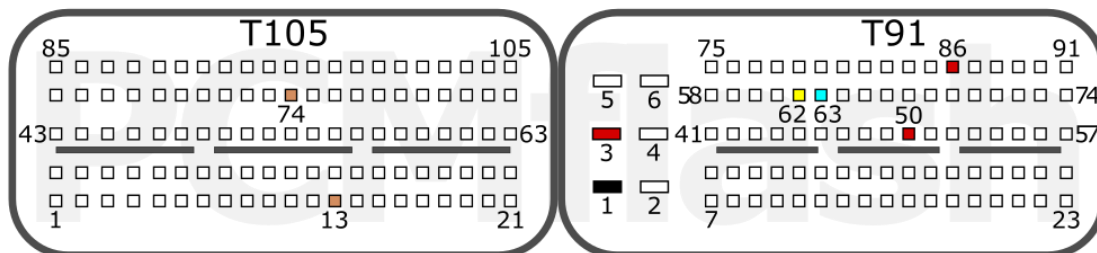

+12V	T91: 3, 50, 86	CAN-L	T91: 63
GND	T91: 1	CAN-H	T91: 62
GPT	T105: 74, 13		

K/H

pcmflash.ru

v.2

2024-05-17

PCMflash

Engine Control Unit

ME17.9.51 TC1762

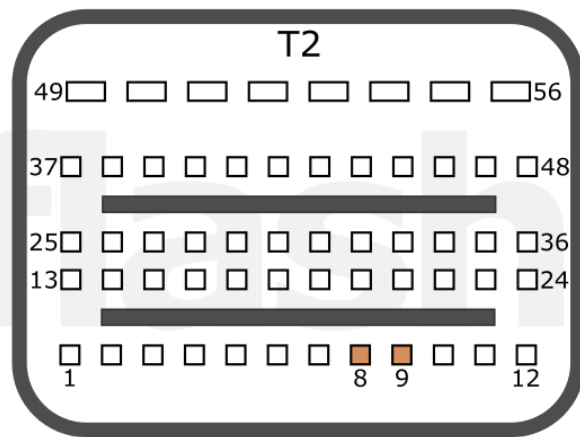
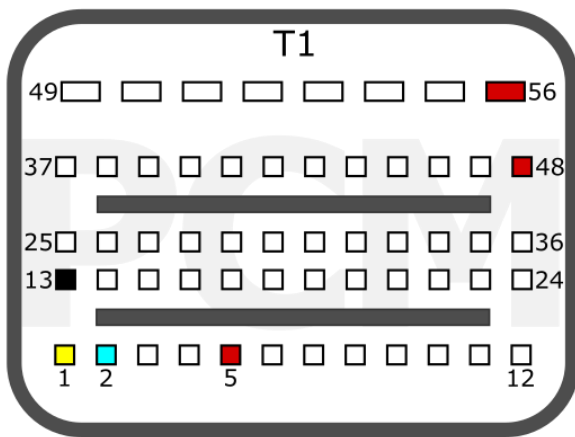

+12V	T1: 56, 48, 5	CAN-L	T1: 2
GND	T1: 13	CAN-H	T1: 1
GPT	T2: 9, 8		

SUZUKI

pcmflash.ru

v.1

2021-09-06

PCMflash

Engine Control Unit

ME17.9.52 TC1782

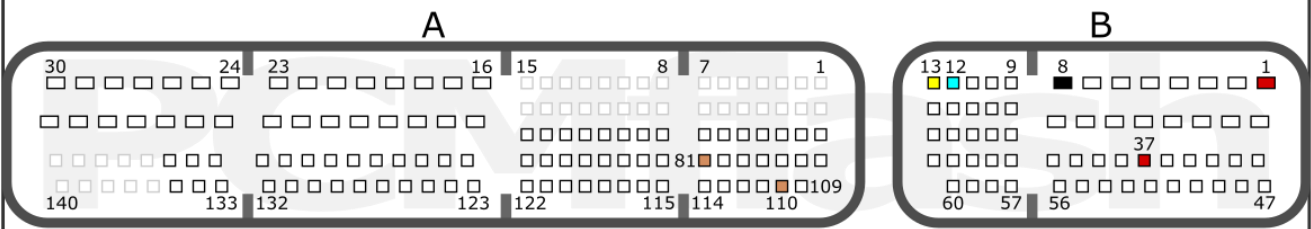

+12V	B: 1, 37	CAN-L	B: 12
GND	B: 8	CAN-H	B: 13
GPT	A: 110, 81		

TOYOTA

pcmflash.ru

v.1

2023-11-06

PCMflash

Engine Control Unit

ME17.9.55 TC1724

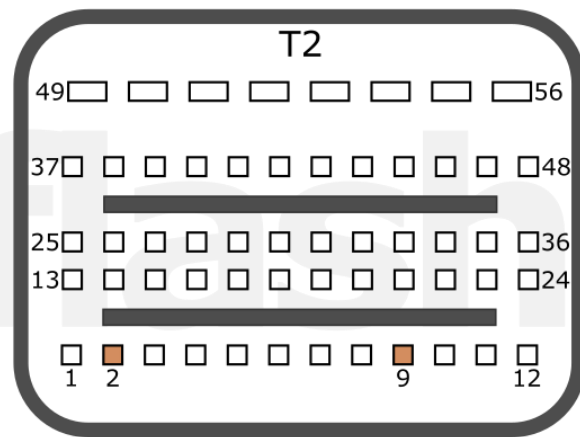
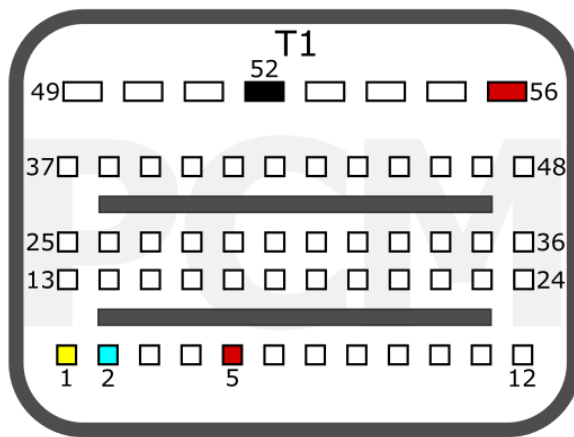

+12V	T1: 56, 5	CAN-L	T1: 2
GND	T1: 52	CAN-H	T1: 1
GPT	T2: 9, 2		

HONDA

PERODUA

pcmflash.ru

v.1

2022-09-01

PCMflash

Engine Control Unit

ME17.9.61 TC1724

Connection version 1

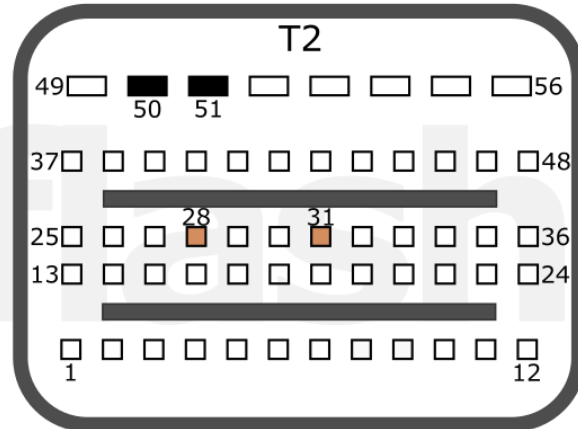
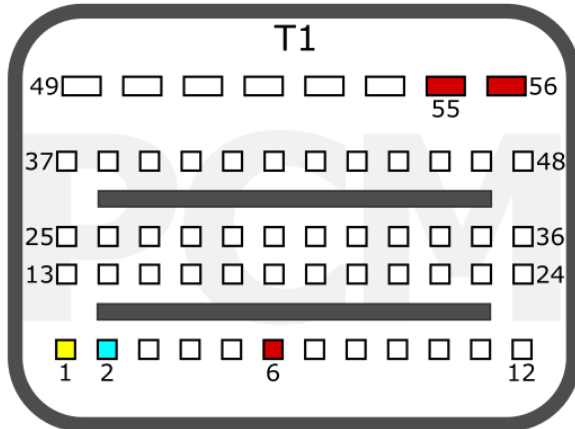

+12V	T1: 55, 56, 6	CAN-L	T1: 2
GND	T2: 50, 51	CAN-H	T1: 1
GPT	T2: 28, 31		

Connection version 2

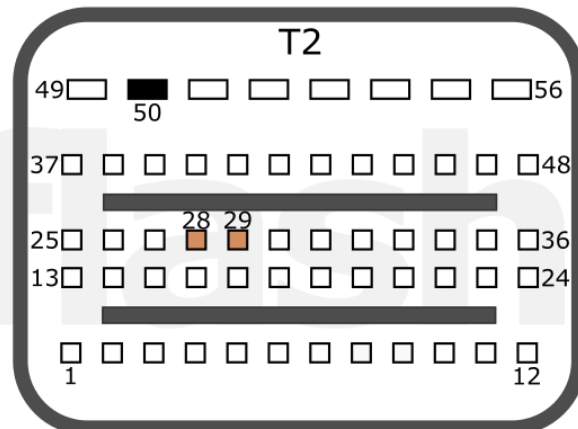
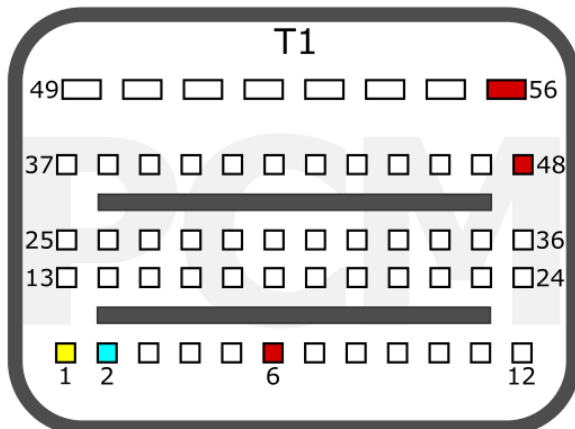

+12V	T1: 56, 48, 6	CAN-L	T1: 2
GND	T2: 50	CAN-H	T1: 1
GPT	T2: 29, 28		

SUZUKI

pcmflash.ru

v.1

2021-09-28

PCMflash

Engine Control Unit

MED17.9.63 TC1793

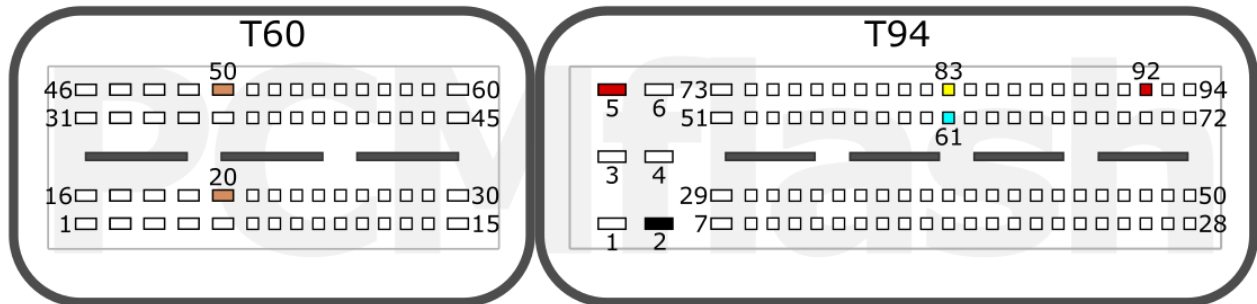

+12V	T94: 5, 92	CAN-L	T94: 61
GND	T94: 2	CAN-H	T94: 83
GPT	T60: 20, 50		

SUZUKI

pcmflash.ru

v.1

2021-12-03

PCMflash

Engine Control Unit

ME17.9.64 TC1724

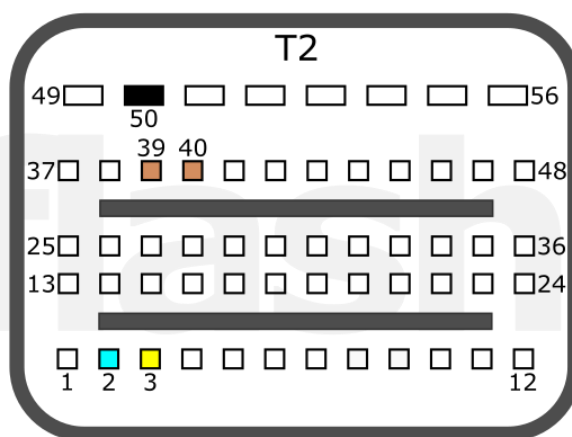
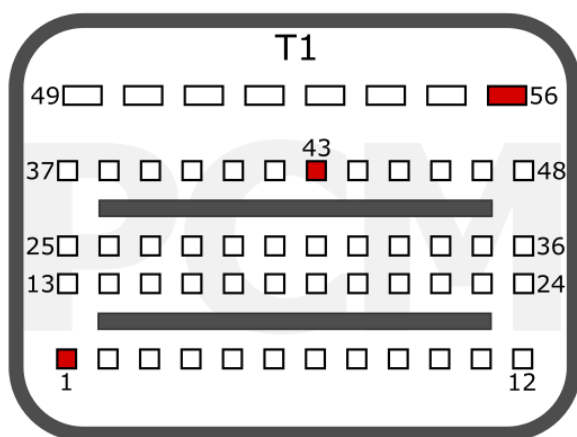

+12V	T1: 1, 43, 56	CAN-L	T2: 2
GND	T2: 50	CAN-H	T2: 3
GPT	T2: 39, 40		

SUZUKI

pcmflash.ru

v.1

2021-12-06

PCMflash

Engine Control Unit

ME17.9.71 TC1724

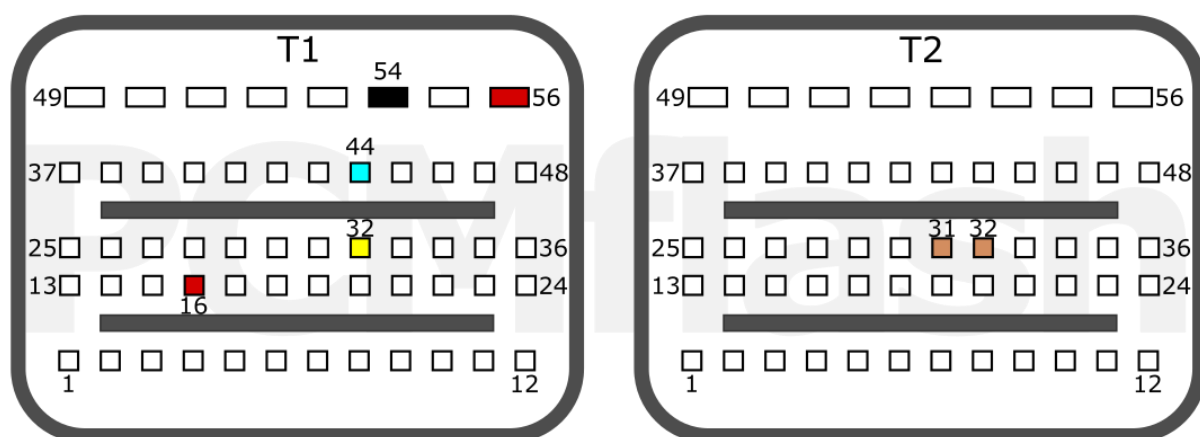

+12V	T1: 56, 16	CAN-L	T1: 44
GND	T1: 54	CAN-H	T1: 32
GPT	T2: 31, 32		

To unlock, read the stock and write it down.
When recording, check the "unlock" box.

NIVA

UAZ

pcmflash.ru

v.1

2021-08-29

PCMflash

Engine Control Unit

ME17.9.74 TC1762

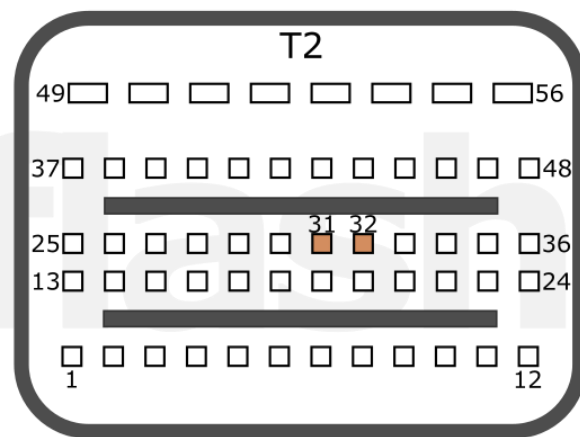
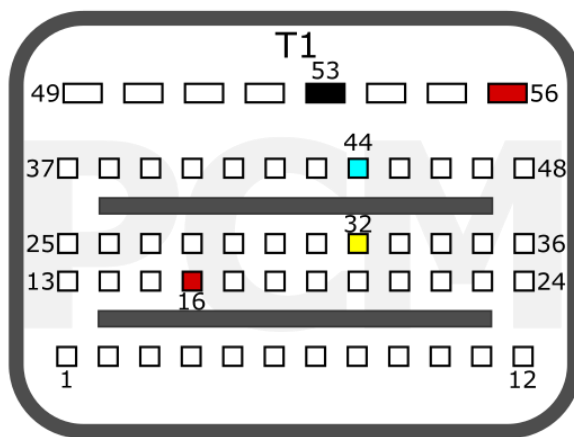

+12V	T1: 56, 16	CAN-L	T1: 44
GND	T1: 53	CAN-H	T1: 32
GPT	T2: 32, 31		

POLARIS

pcmflash.ru

v.1

2023-08-12

PCMflash

Engine Control Unit

EDC17C06 TC1766

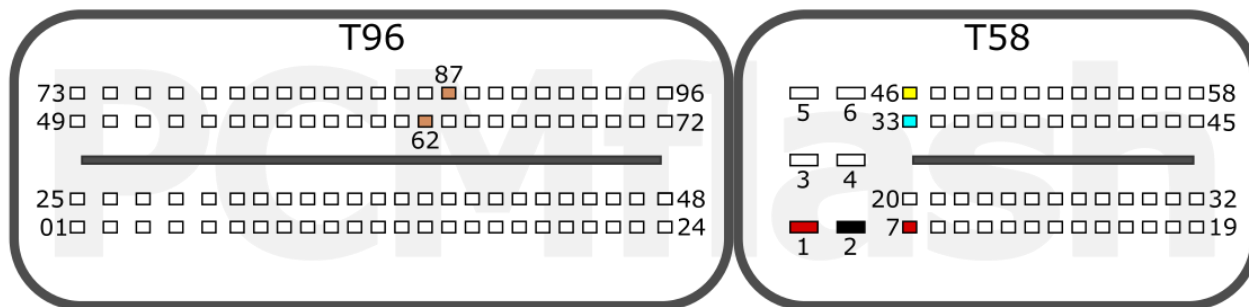

+12V	T58: 1, 7	CAN-L	T58: 33
GND	T58: 2	CAN-H	T58: 46
GPT	T96: 62, 87		

BMW

pcmflash.ru

v.1

2021-09-25

PCMflash

Engine Control Unit

EDC17C08 TC1766

Connection version 1

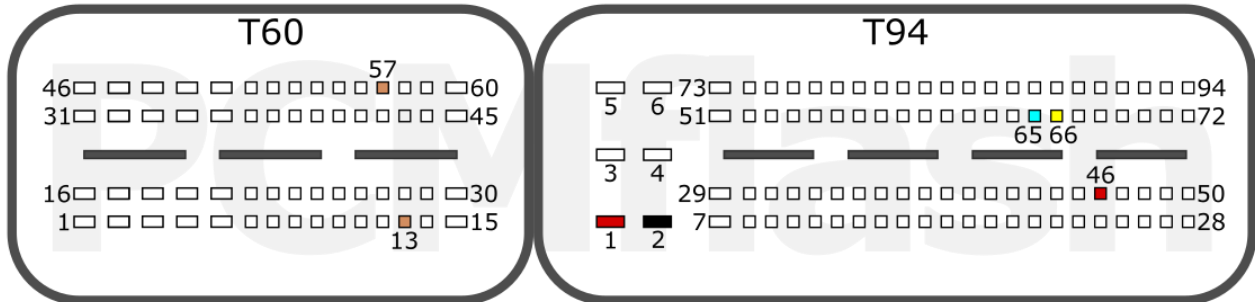

+12V	T94: 1, 46	CAN-L	T94: 65
GND	T94: 2	CAN-H	T94: 66
GPT	T60: 13, 57		

Connection version 2

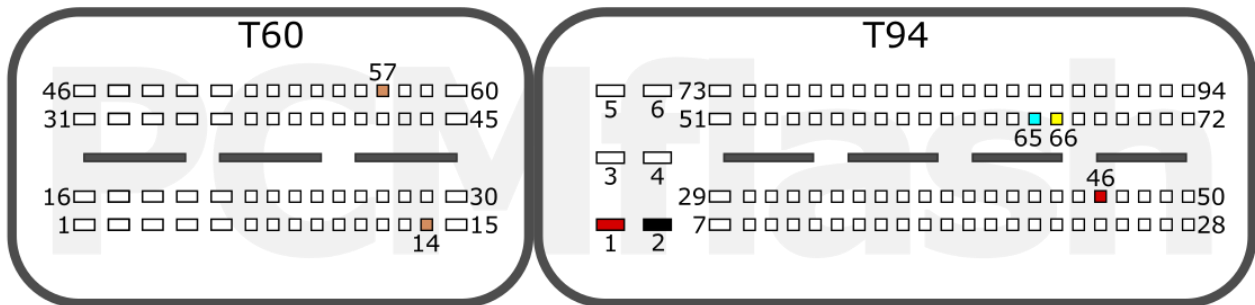

+12V	T94: 1, 46	CAN-L	T94: 65
GND	T94: 2	CAN-H	T94: 66
GPT	T60: 14, 57		

K/H

PCMflash

Engine Control Unit

EDC17C10 TC1797

PSA

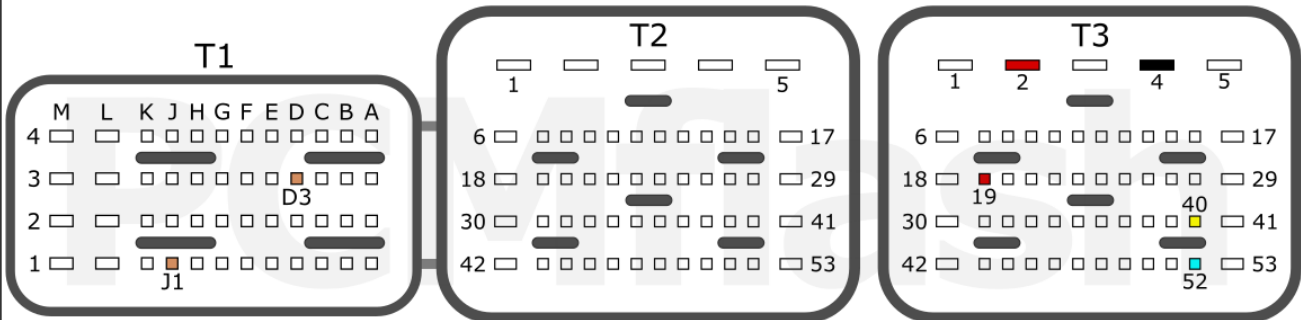

+12V	T3: 2, 19	CAN-L	T3: 52
GND	T3: 4	CAN-H	T3: 40
GPT	T1: J1, D3		

FORD

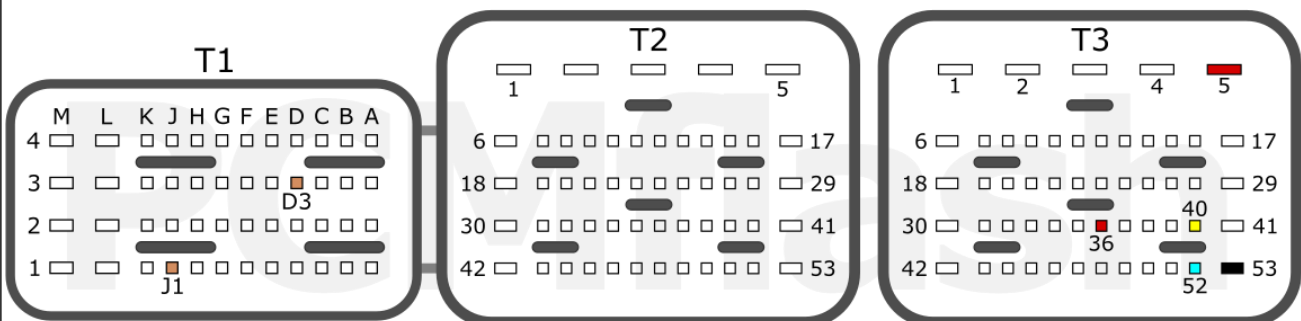

+12V	T3: 5, 36	CAN-L	T3: 52
GND	T3: 53	CAN-H	T3: 40
GPT	T1: J1, D3		

FORD

PSA

pcmflash.ru

v.2

2021-10-11

PCMflash

Engine Control Unit

EDC17C11 TC1766

Connection version 1

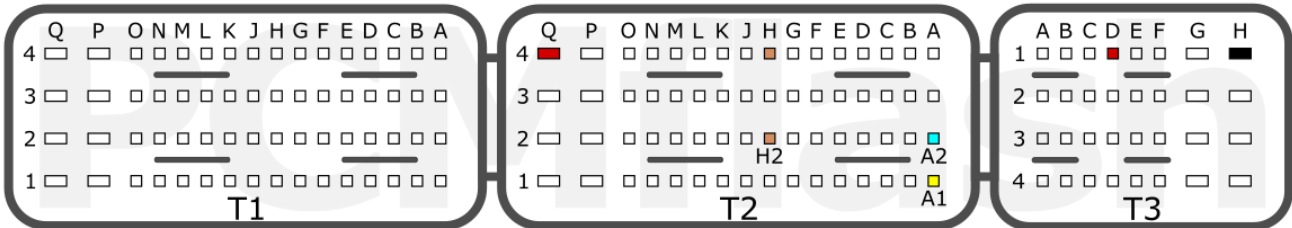

+12V	T2: Q4, T3:D1	CAN-L	T2: A2
GND	T3: H1	CAN-H	T2: A1
GPT	T2: H2, H4		

Connection version 2

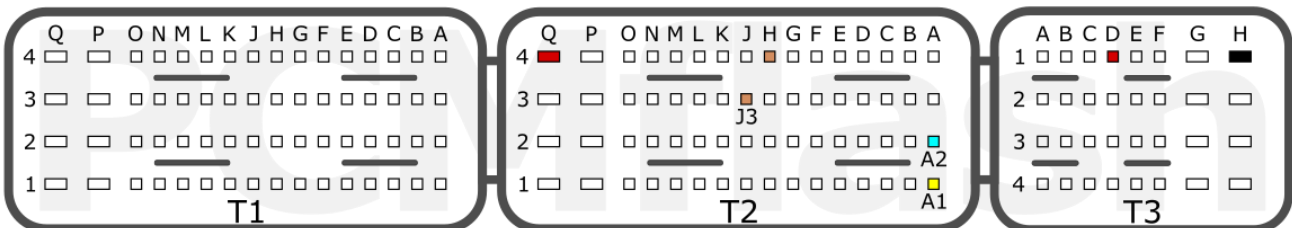

+12V	T2: Q4, T3:D1	CAN-L	T2: A2
GND	T3: H1	CAN-H	T2: A1
GPT	T2: H4, J3		

NISSAN

OPEL

RENAULT

pcmflash.ru

v.1

2021-09-29

PCMflash

Engine Control Unit

EDC17C18 TC1766

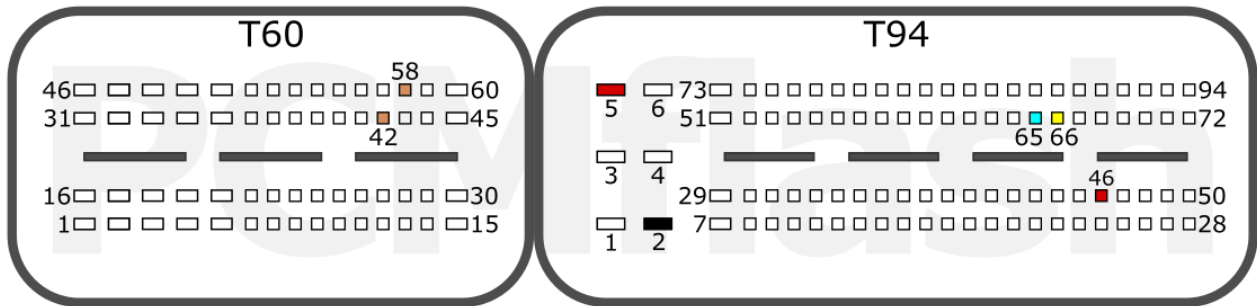

+12V	T94: 5, 46	CAN-L	T94: 65
GND	T94: 2	CAN-H	T94: 66
GPT	T60: 42, 58		

OPEL

pcmflash.ru

v.1

2021-09-30

PCMflash

Engine Control Unit

EDC17C19 TC1792

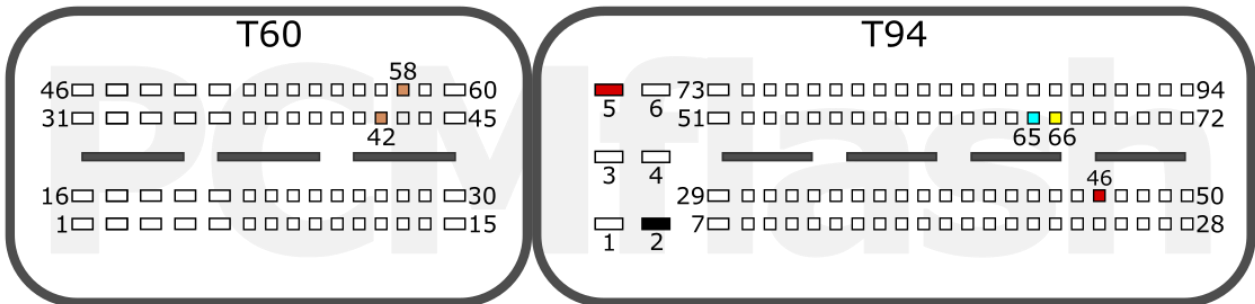

+12V	T94: 5, 46	CAN-L	T94: 65
GND	T94: 2	CAN-H	T94: 66
GPT	T60: 42, 58		

OPEL

pcmflash.ru

v.1

2021-09-25

PCMflash

Engine Control Unit

EDC17C41 TC1797

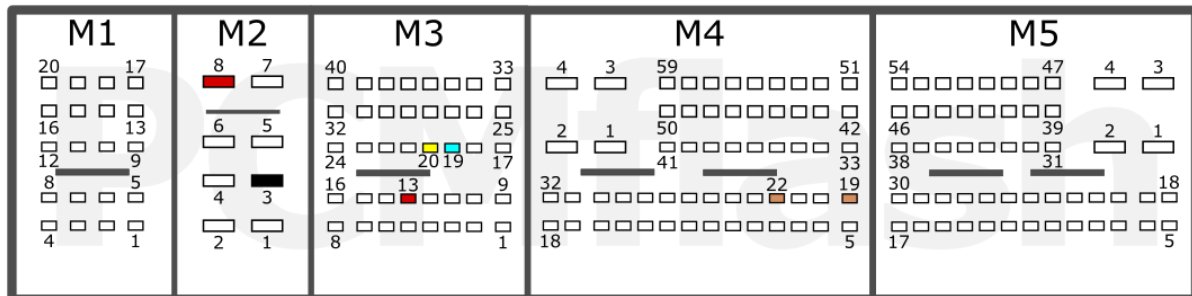

+12V	M2: 8; M3: 13	CAN-L	M3: 19
GND	M2: 3	CAN-H	M3: 20
GPT	M4: 22, 19		

BMW

pcmflash.ru

v.1

2022-01-24

PCMflash

Engine Control Unit

EDC17C42 TC1767

Connection version 1

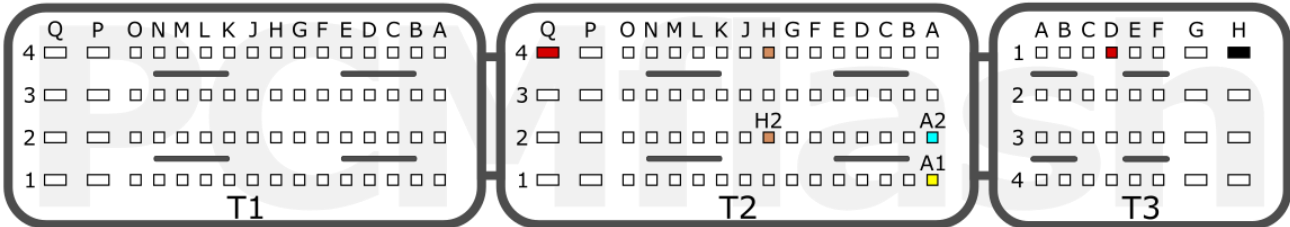

+12V	T2: Q4, T3:D1	CAN-L	T2: A2
GND	T3: H1	CAN-H	T2: A1
GPT	T2: H2, H4		

Connection version 2

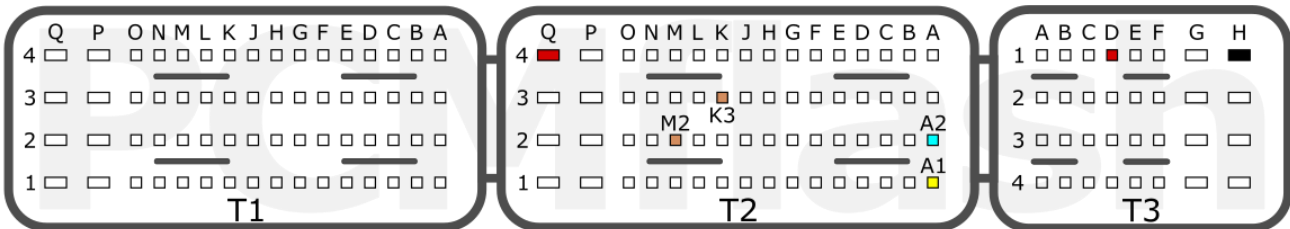

+12V	T2: Q4, T3:D1	CAN-L	T2: A2
GND	T3: H1	CAN-H	T2: A1
GPT	T2: M2, K3		

Connection version 3

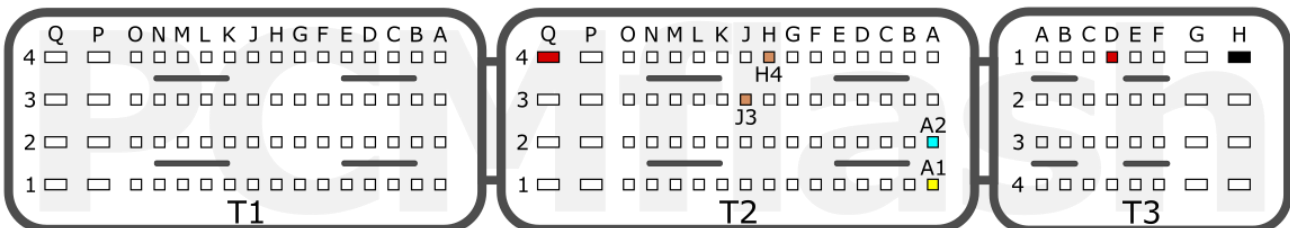

+12V	T2: Q4, T3:D1	CAN-L	T2: A2
GND	T3: H1	CAN-H	T2: A1
GPT	T2: H4, J3		

RENAULT

pcmflash.ru

v.3

2024-03-06

PCMflash

Engine Control Unit

EDC17C43 TC1797

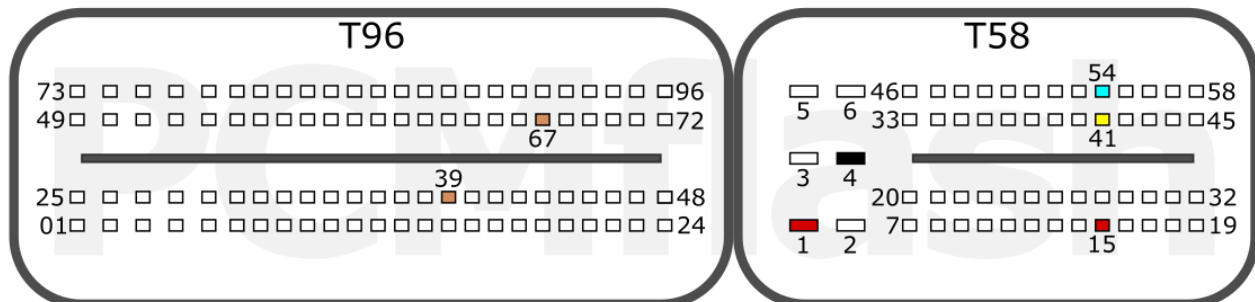

+12V	T58: 1, 15	CAN-L	T58: 54
GND	T58: 4	CAN-H	T58: 41
GPT	T96: 39, 67		

MB

pcmflash.ru

v.1

2022-31-03

PCMflash

Engine Control Unit

EDC17C45 TC1767

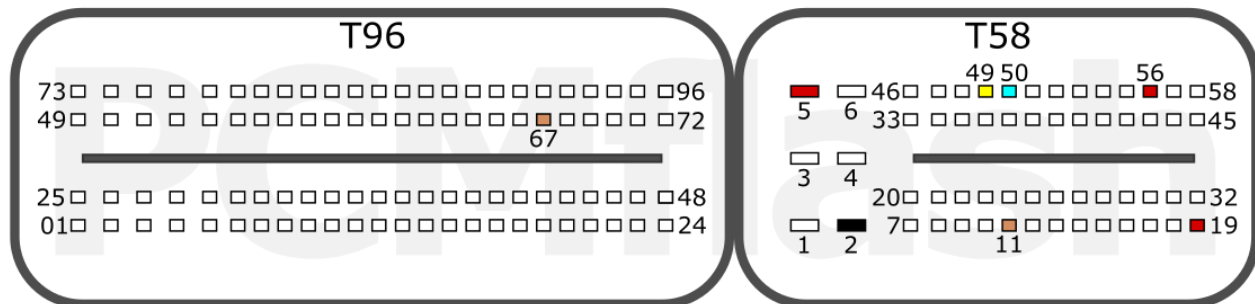

+12V	T58: 5, 56, 19	CAN-L	T58: 50
GND	T58: 2	CAN-H	T58: 49
GPT	T96: 67, T58:11		

NISSAN

pcmflash.ru

v.1

2021-12-08

PCMflash

Engine Control Unit

EDC17C46 TC1767

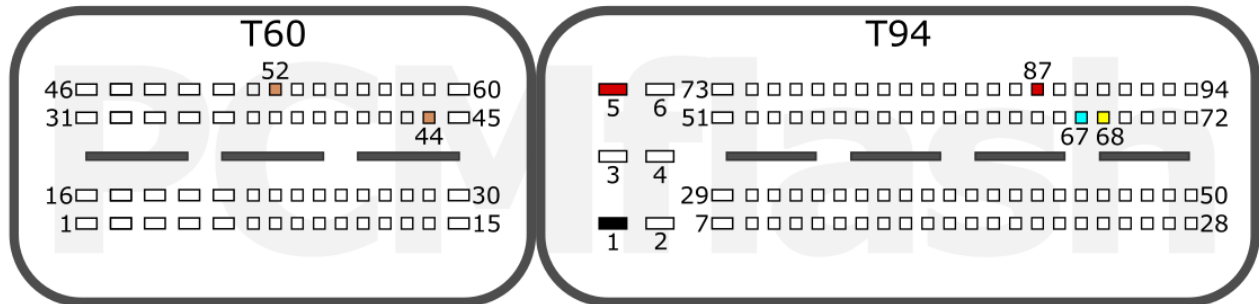

+12V	T94: 5, 87	CAN-L	T94: 67
GND	T94: 1	CAN-H	T94: 68
GPT	T60: 44, 52		

VAG

pcmflash.ru

v.1

2021-08-25

PCMflash

Engine Control Unit

EDC17C47 TC1782

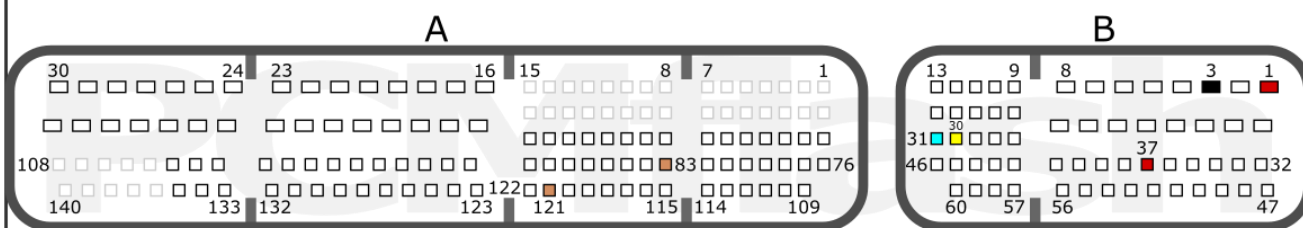

+12V	B: 1, 37	CAN-L	B: 31
GND	B: 3	CAN-H	B: 30
GPT	A: 83, 121		

TOYOTA

pcmflash.ru

v.1

2022-06-15

PCMflash

Engine Control Unit

EDC17C49 TC1797

Connection version 1

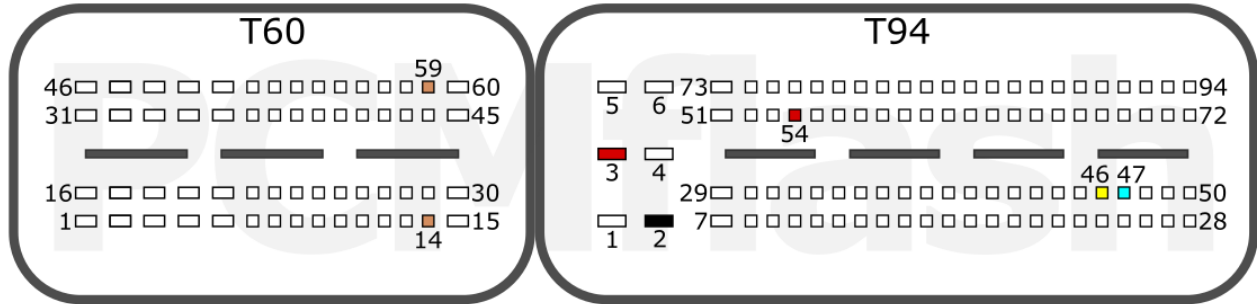

+12V	T94: 3, 54	CAN-L	T94: 47
GND	T94: 2	CAN-H	T94: 46
GPT	T60: 14, 59		

Connection version 2

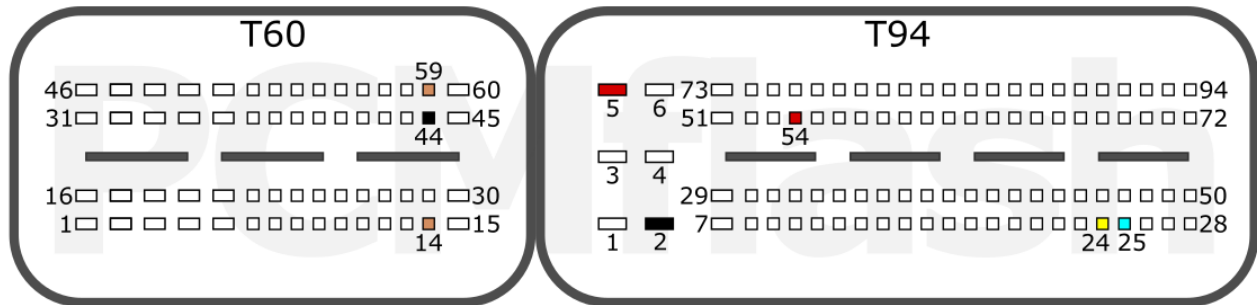

+12V	T94: 5, 54	CAN-L	T94: 25
GND	T60: 44, T94: 2	CAN-H	T94: 24
GPT	T60: 14, 59*		

*10-47 uF 50v capacitor required on 59 GPT line /
Подключить сигнал 59 GPT к ЭБУ через конденсатор 10-47 мкФ

Connection version 3

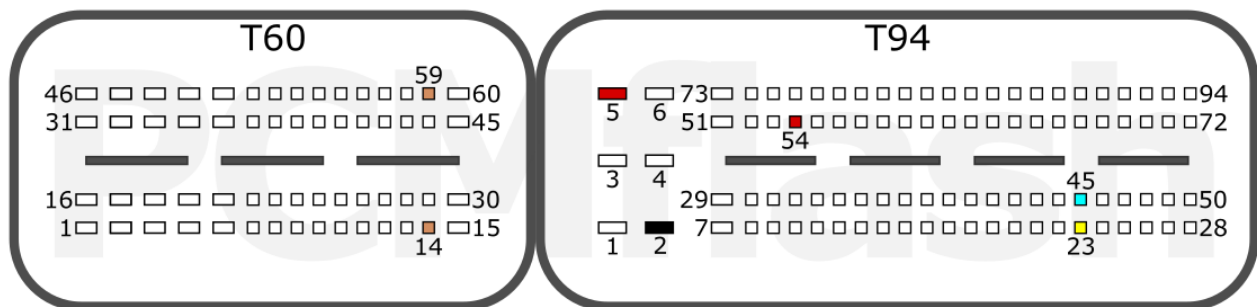

+12V	T94: 5, 54	CAN-L	T94: 45
GND	T94: 2	CAN-H	T94: 23
GPT	T60: 59, 14		

FIAT

JEEP

IVECO

OPEL

pcmflash.ru

v.3

2023-03-27

PCMflash

Engine Control Unit

EDC17C50 TC1797

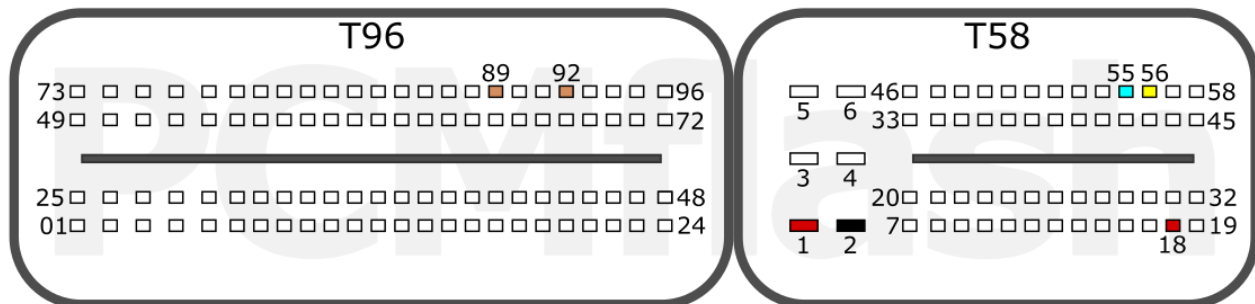

+12V	T58: 1, 18	CAN-L	T58: 55
GND	T58: 2	CAN-H	T58: 56
GPT	T96: 89, 92		

BMW

pcmflash.ru

v.1

2021-09-11

PCMflash

Engine Control Unit

EDC17C53 TC1767

Connection version 1

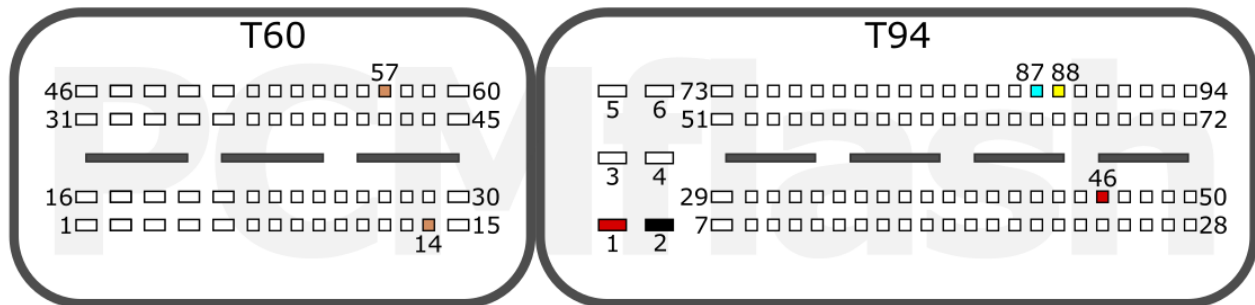

+12V	T94: 1, 46	CAN-L	T94: 87
GND	T94: 2	CAN-H	T94: 88
GPT	T60: 14, 57		

Connection version 2

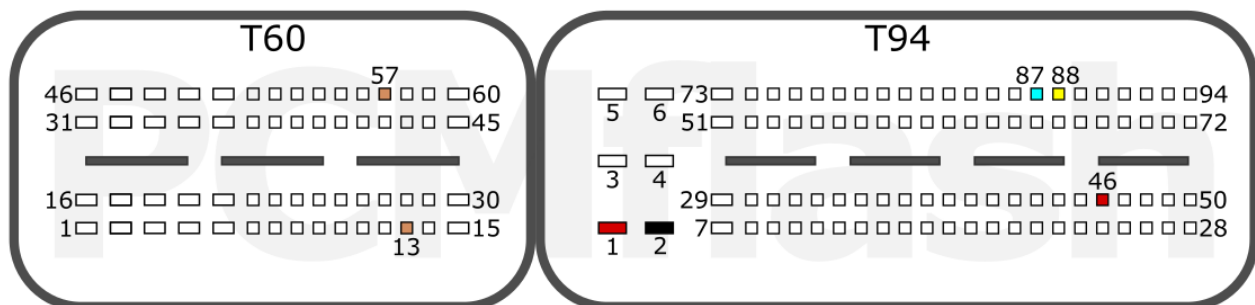

+12V	T94: 1, 46	CAN-L	T94: 87
GND	T94: 2	CAN-H	T94: 88
GPT	T60: 13, 57		

HAVAL

JAC

K/H

pcmflash.ru

v.2

2022-12-20

PCMflash

Engine Control Unit

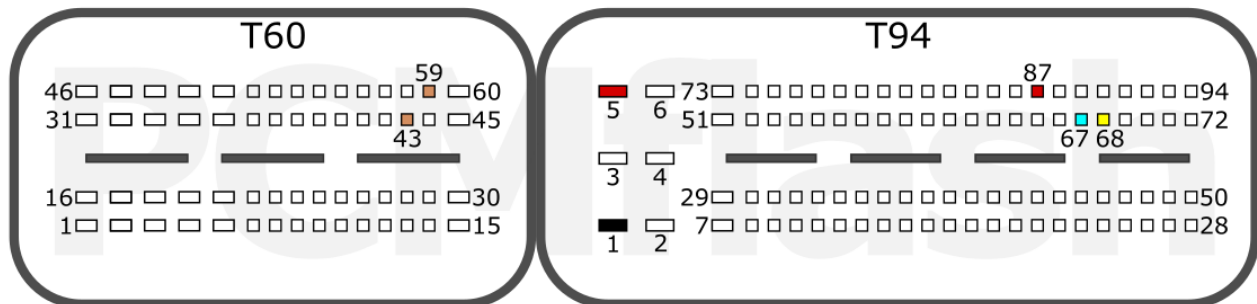
EDC17C54 TC1797

+12V	T94: 5, 87	CAN-L	T94: 67
GND	T94: 1	CAN-H	T94: 68
GPT	T60: 43, 59		

VAG

pcmflash.ru

v.1

2021-08-29

PCMflash

Engine Control Unit

EDC17C55 TC1767

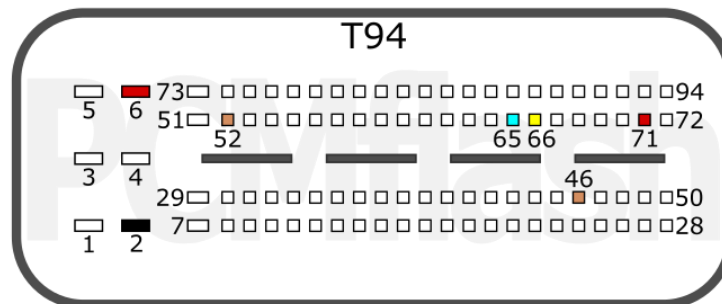

+12V	6, 71	CAN-L	65
GND	2	CAN-H	66
GPT	46, 52		

ALL

pcmflash.ru

v.1

2024-08-05

PCMflash

Engine Control Unit

EDC17C56 TC1797

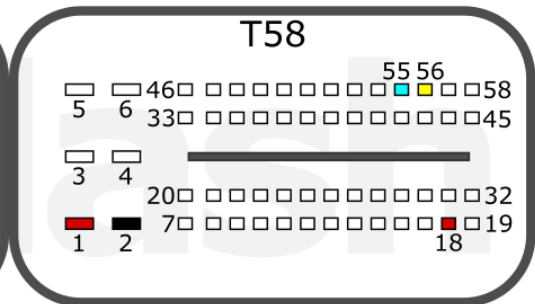

+12V	T58: 1, 18	CAN-L	T58: 55
GND	T58: 2	CAN-H	T58: 56
GPT	T96: 92, 89		

BMW

pcmflash.ru

v.1

2021-08-25

PCMflash

Engine Control Unit

EDC17C57 TC1793

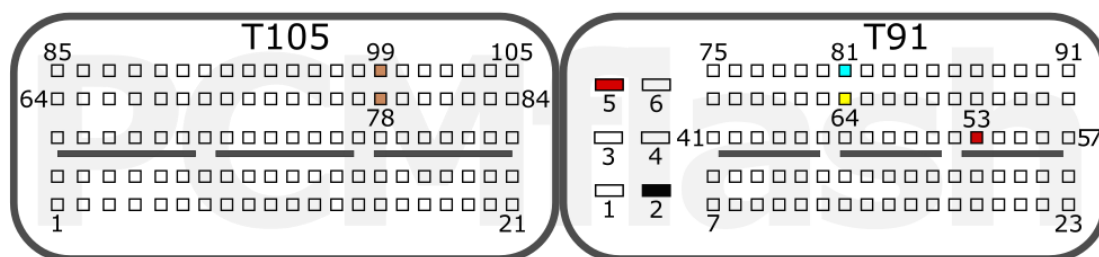

+12V	T91: 5, 53	CAN-L	T91: 81
GND	T91: 2	CAN-H	T91: 64
GPT	T105: 99, 78		

K/H

pcmflash.ru

v.1

2021-08-26

PCMflash

Engine Control Unit

EDC17C59 TC1767

1.3-LITRE ENGINE

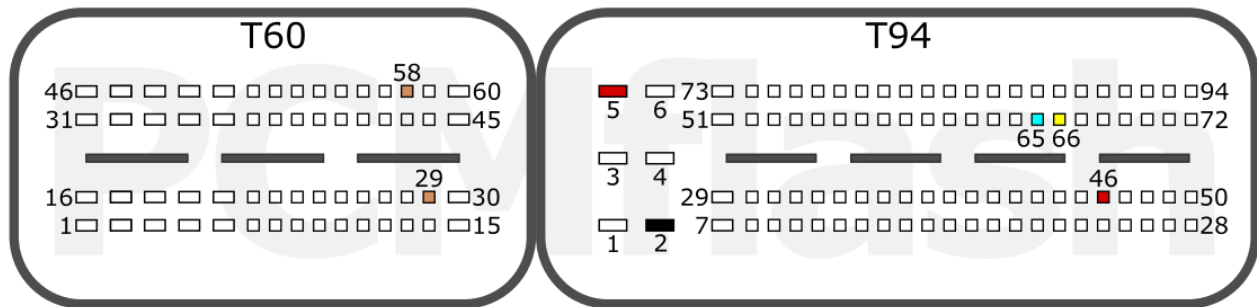

+12V	T94: 5, 46	CAN-L	T94: 65
GND	T94: 2	CAN-H	T94: 66
GPT	T60: 29, 58		

2.0-LITRE ENGINE

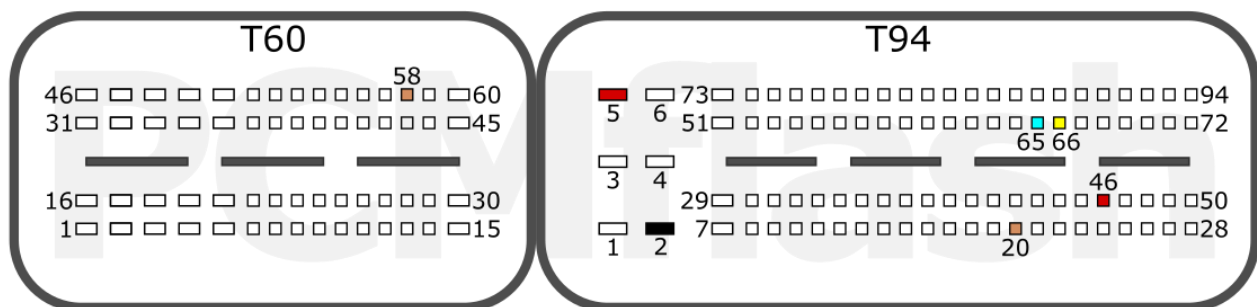

+12V	T94: 5, 46	CAN-L	T94: 65
GND	T94: 2	CAN-H	T94: 66
GPT	T60: 58, T94: 20		

OPEL

pcmflash.ru

v.1

2021-09-11

PCMflash

Engine Control Unit

EDC17C60 TC1793

Connection version 1

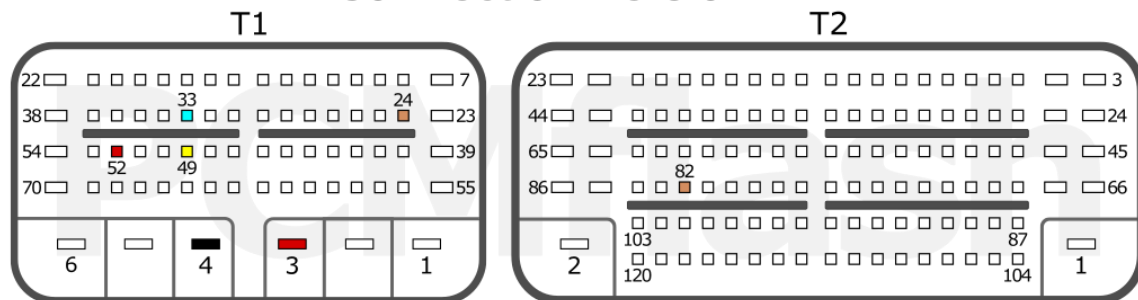

+12V	T1: 52, 3	CAN-L	T1: 33
GND	T1: 4	CAN-H	T1: 49
GPT	T1: 24, T2:82		

Connection version 2

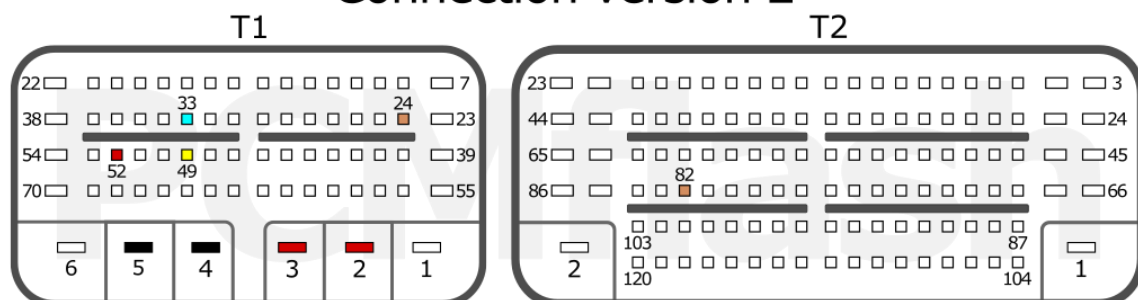

+12V	T1: 52, 3, 2	CAN-L	T1: 33
GND	T1: 4, 5	CAN-H	T1: 49
GPT	T1: 24, T2:82		

PSA

pcmflash.ru

v.1

2021-11-01

PCMflash

Engine Control Unit

EDC17C63 TC1724

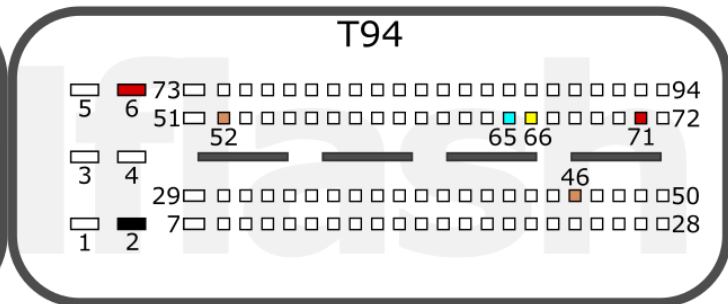
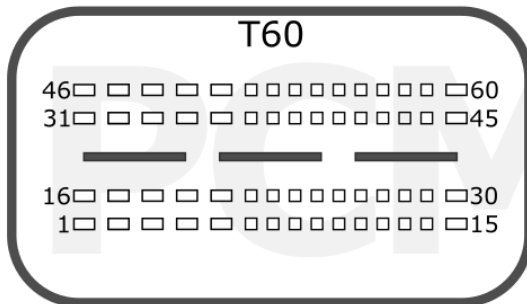

+12V	T94: 6, 71	CAN-L	T94: 65
GND	T94: 2	CAN-H	T94: 66
GPT	T94: 46, 52		

ISUZU

pcmflash.ru

v.1

2021-10-07

PCMflash

Engine Control Unit

EDC17C69 TC1793

Connection version 1

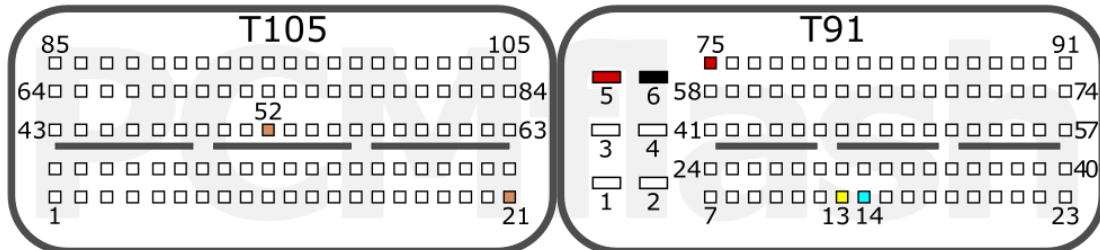

+12V	T91: 5, 75	CAN-L	T91: 14
GND	T91: 6	CAN-H	T91: 13
GPT	T105: 52, 21		

Connection version 2

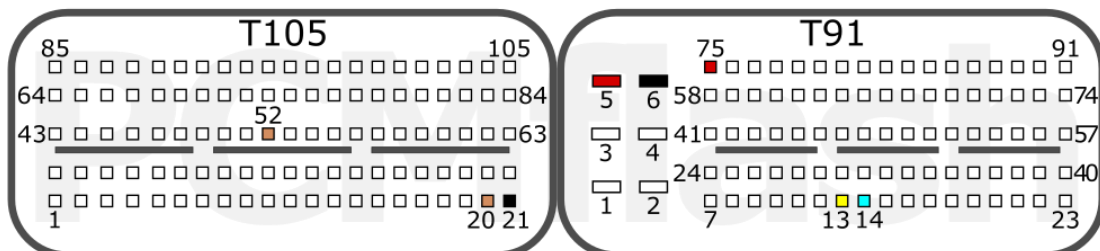

+12V	T91: 5, 75	CAN-L	T91: 14
GND	T105: 21, T91: 6	CAN-H	T91: 13
GPT	T105: 52, 20*		

*Install 10uF capacitor on 20 GPT line

JEEP

IVECO

pcmflash.ru

v.2

2023-11-06

PCMflash

Engine Control Unit

EDC17C70 TC1793

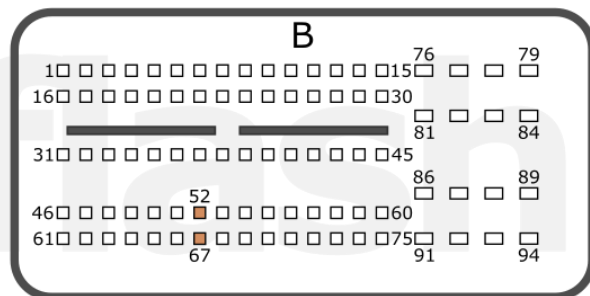
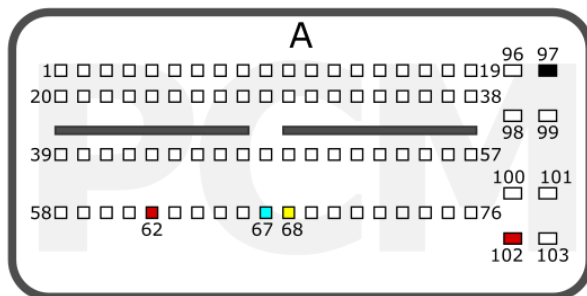

+12V	A: 62, 102	CAN-L	A: 67
GND	A: 97	CAN-H	A: 68
GPT	B: 67, 52		

FORD

pcmflash.ru

v.1

2021-09-08

PCMflash

Engine Control Unit

EDC17C73 TC1793

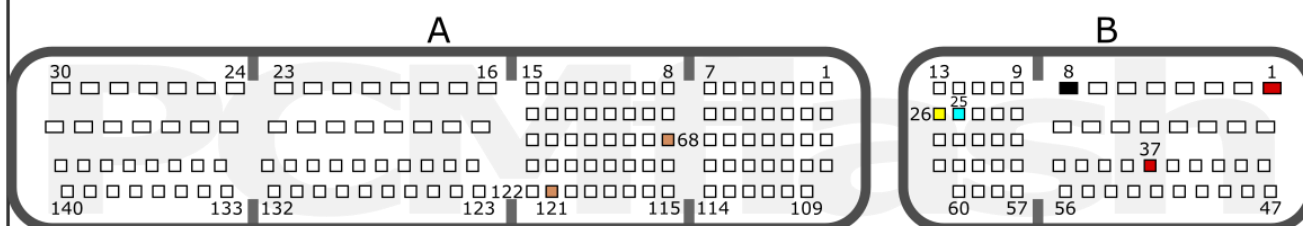

+12V	B: 1, 37	CAN-L	B: 25
GND	B: 8	CAN-H	B: 26
GPT	A: 68, 121		

TOYOTA

pcmflash.ru

v.1

2021-10-08

PCMflash

Engine Control Unit

EDC17C74 TC1793

Connection version 1

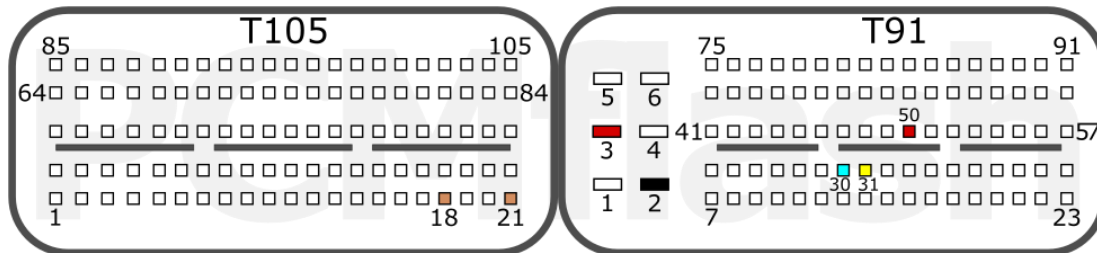

+12V	T91: 3, 50	CAN-L	T91: 30
GND	T91: 2	CAN-H	T91: 31
GPT	T105: 18, 21		

Connection version 2

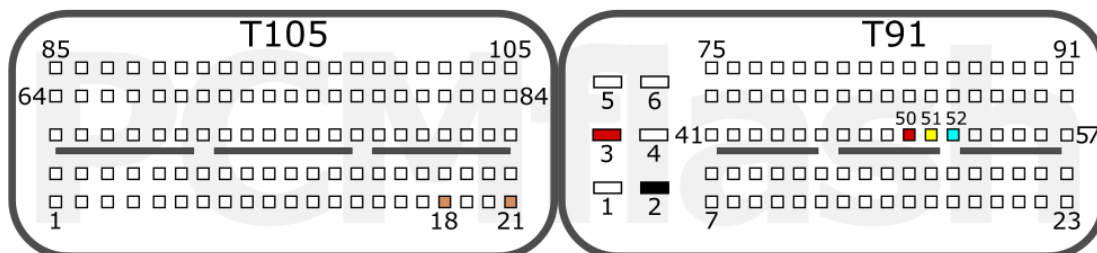

+12V	T91: 3, 50	CAN-L	T91: 52
GND	T91: 2	CAN-H	T91: 51
GPT	T105: 18, 21		

VAG

pcmflash.ru

v.1

2021-10-13

PCMflash

Engine Control Unit

EDC17C76 TC1793

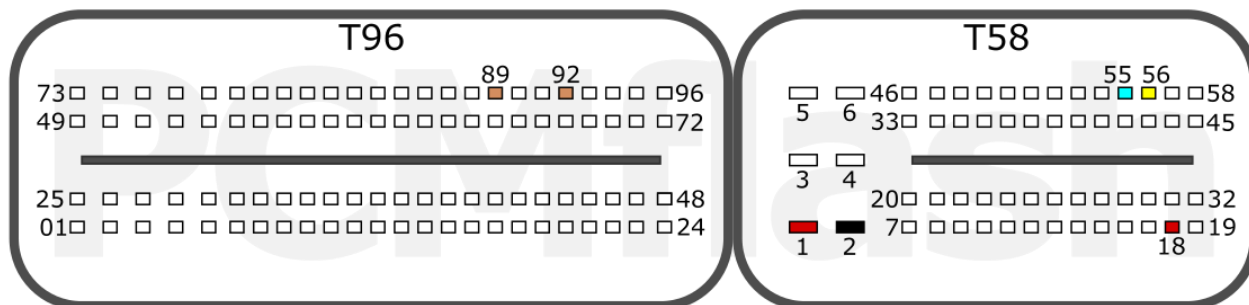

+12V	T58: 1, 18	CAN-L	T58: 55
GND	T58: 2	CAN-H	T58: 56
GPT	T96: 92, 89		

BMW

pcmflash.ru

v.1

2023-04-01

PCMflash

Engine Control Unit

EDC17C79 TC1797

Connection version 1

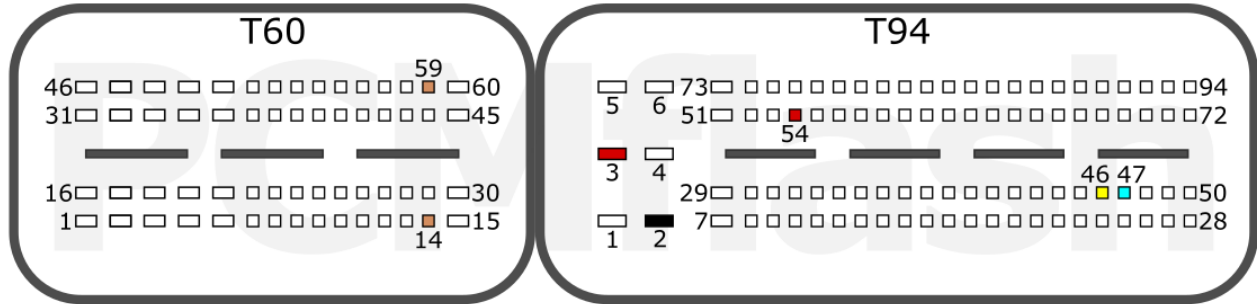

+12V	T94: 3, 54	CAN-L	T94: 47
GND	T94: 2	CAN-H	T94: 46
GPT	T60: 14, 59		

Connection version 2

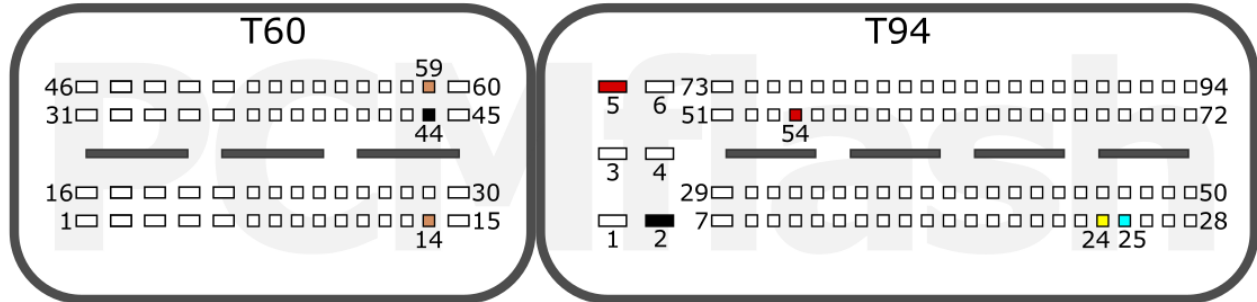

+12V	T94: 5, 54	CAN-L	T94: 25
GND	T60: 44, T94: 2	CAN-H	T94: 24
GPT	T60: 14, 59*		

*10-47 uF 50v capacitor required on 59 GPT line /
Подключить сигнал 59 GPT к ЭБУ через конденсатор 10-47 мкФ

Connection version 3

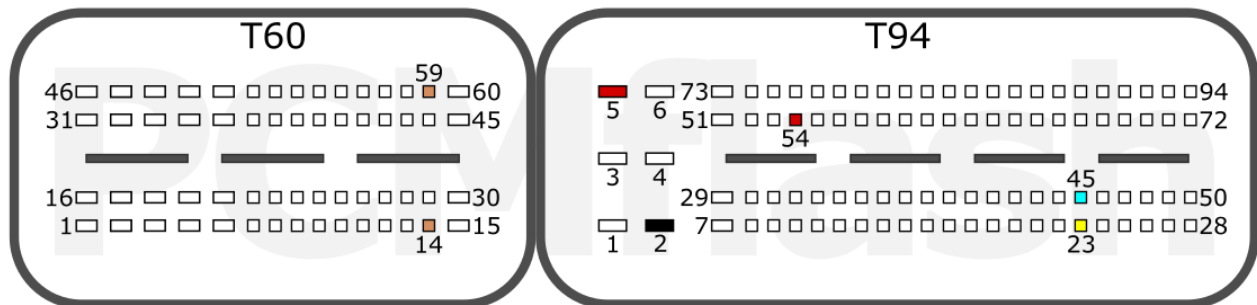

+12V	T94: 5, 54	CAN-L	T94: 45
GND	T94: 2	CAN-H	T94: 23
GPT	T60: 59, 14		

DODGE

JEEP

IVECO

MASERATI

pcmflash.ru

v.4

2023-03-23

PCMflash

Engine Control Unit

EDC17C81 TC1782

Connection version 1

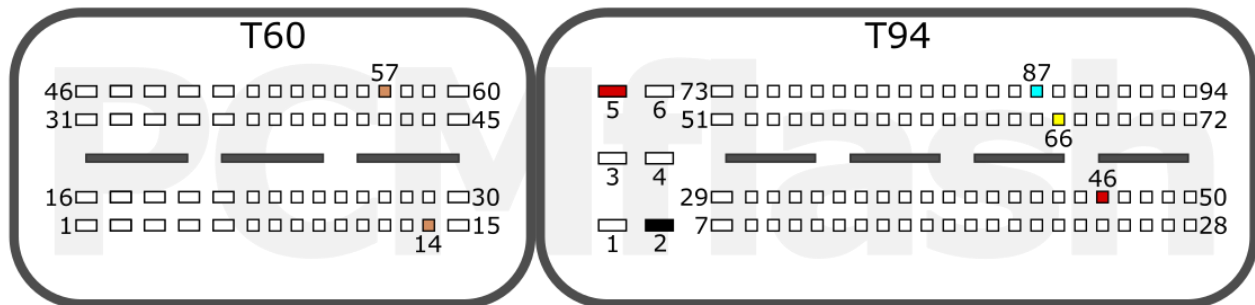

+12V	T94: 5, 46	CAN-L	T94: 87
GND	T94: 2	CAN-H	T94: 66
GPT	T60: 14, 57		

Connection version 2

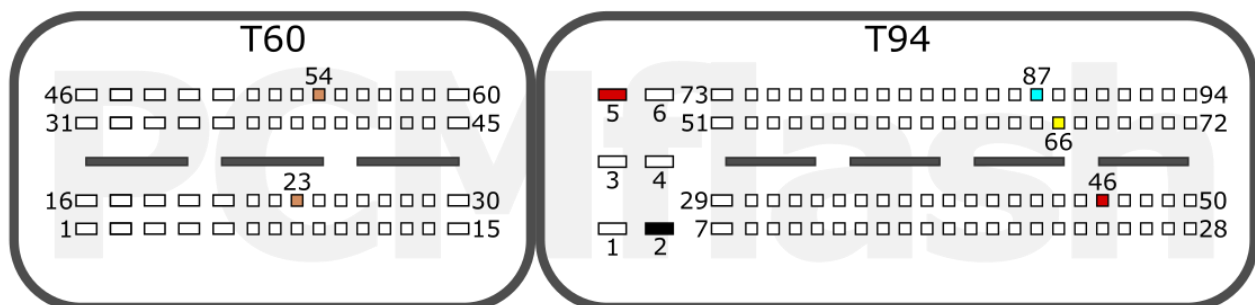

+12V	T94: 5, 46	CAN-L	T94: 87
GND	T94: 2	CAN-H	T94: 66
GPT	T60: 23, 54		

TRUCKS

pcmflash.ru

v.2

2024-04-10

PCMflash

Engine Control Unit

EDC17C83 TC1793

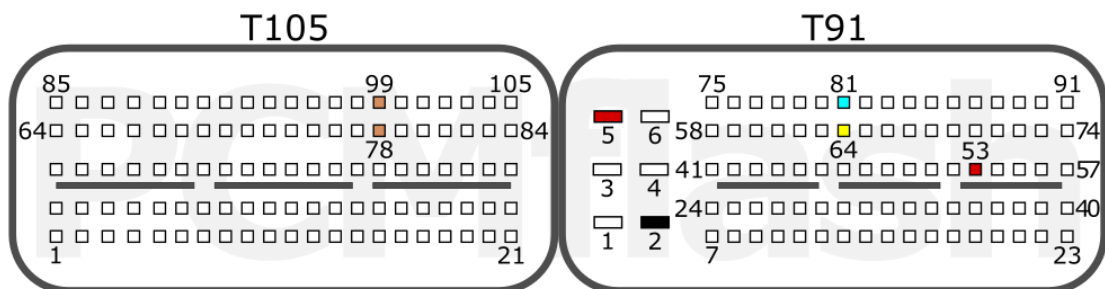

+12V	T91: 5, 53	CAN-L	T91: 81
GND	T91: 2	CAN-H	T91: 64
GPT	T105: 78, 99		

ISUZU

pcmflash.ru

v.1

2021-10-16

PCMflash

Engine Control Unit

EDC17C84 TC1782

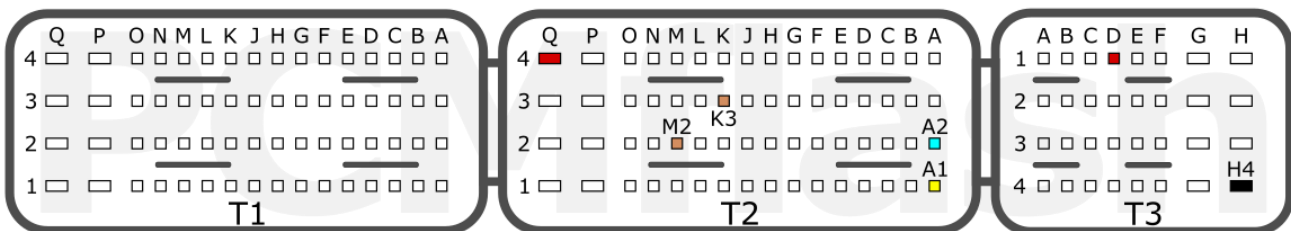

+12V	T2: Q4, T3: D1	CAN-L	T2: A2
GND	T3: H4	CAN-H	T2: A1
GPT	T2: M2, K3		

NISSAN

OPEL

RENAULT

pcmflash.ru

v.1

2021-10-15

PCMflash

Engine Control Unit

EDC17CP04 TC1796

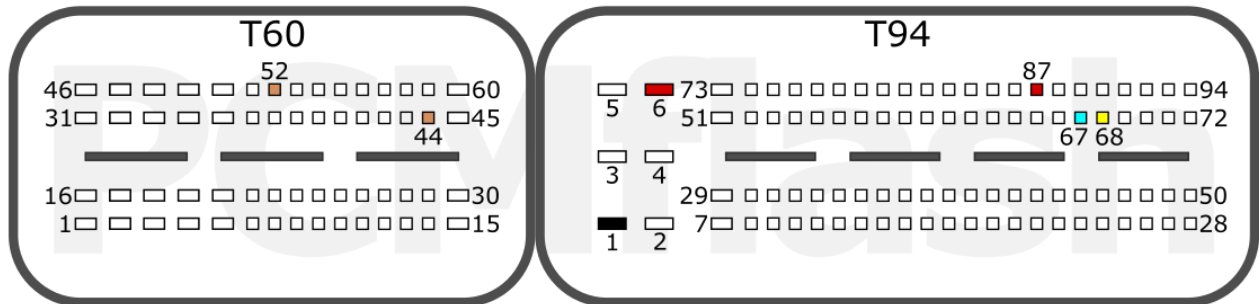

+12V	T94: 6, 87	CAN-L	T94: 67
GND	T94: 1	CAN-H	T94: 68
GPT	T60: 52, 44		

AUDI

pcmflash.ru

v.1

2021-09-09

PCMflash

Engine Control Unit

EDC17CP05 TC1796/TC1797

T1

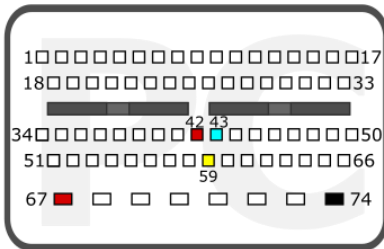

T2

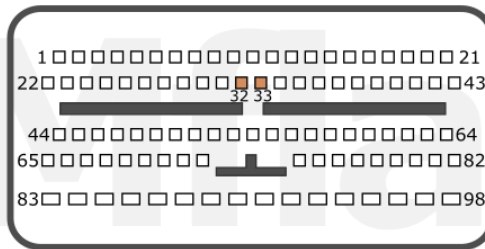

T3

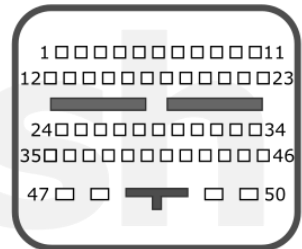

+12V	T1: 42, 67	CAN-L	T1: 43
GND	T1: 74	CAN-H	T1: 59
GPT	T2: 32, 33		

FORD

pcmflash.ru

v.2

2022-08-09

PCMflash

Engine Control Unit

EDC17CP06 TC1796

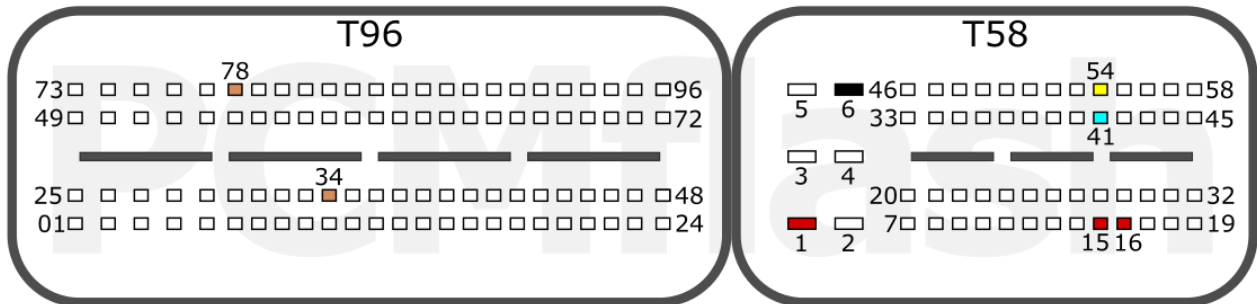

+12V	T58: 1, 15, 16	CAN-L	T58: 41
GND	T58: 6	CAN-H	T58: 54
GPT	T96: 34, 78		

HONDA

pcmflash.ru

v.1

2021-10-10

PCMflash

Engine Control Unit

EDC17CP07 TC1766

T1

T2

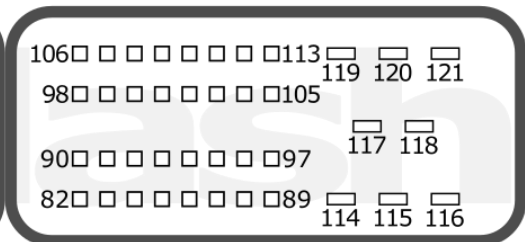
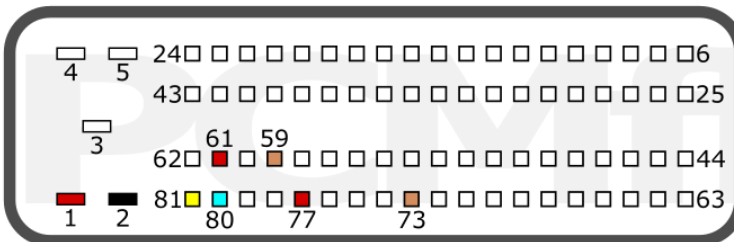

+12V	T1: 1, 61, 77	CAN-L	T1: 80
GND	T1: 2	CAN-H	T1: 81
GPT	T1: 59, 73		

TOYOTA

pcmflash.ru

v.1

2021-09-06

PCMflash

Engine Control Unit

EDC17CP09 TC1796

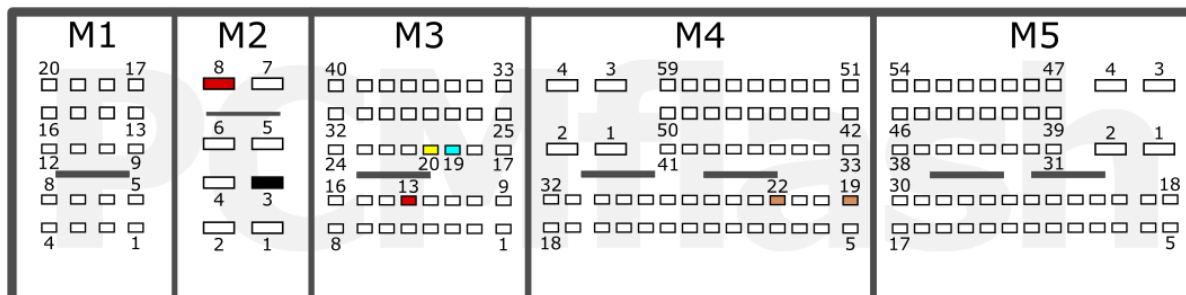

+12V	M2: 8, M3:13	CAN-L	M3: 19
GND	M2: 3	CAN-H	M3: 20
GPT	M4: 22, 19		

BMW

pcmflash.ru

v.1

2021-10-12

PCMflash

Engine Control Unit

EDC17CP10 TC1796

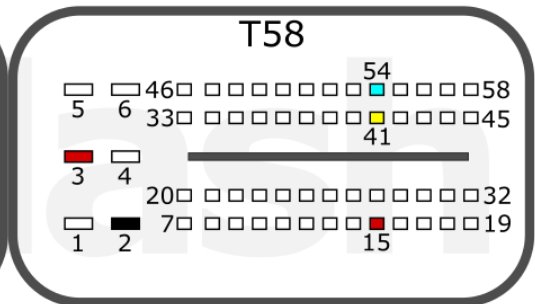
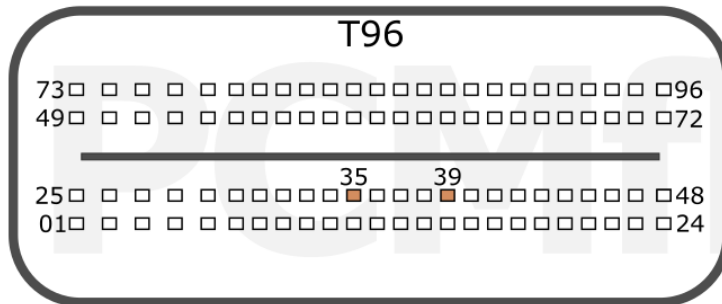

+12V	T58: 3, 15	CAN-L	T58: 54
GND	T58: 2	CAN-H	T58: 41
GPT	T96: 35, 39		

MB

pcmflash.ru

v.2

2024-05-29

PCMflash

Engine Control Unit

EDC17CP14 TC1796

Connection version 1

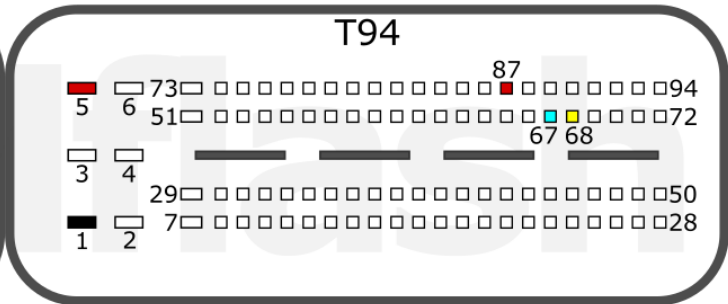
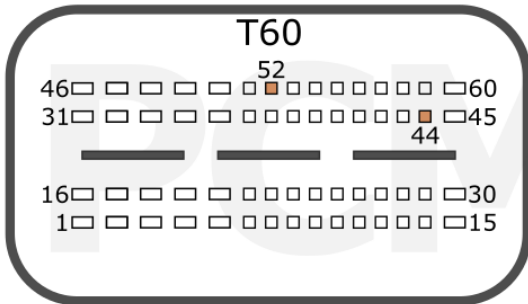

+12V	T94: 5, 87	CAN-L	T94: 67
GND	T94: 1	CAN-H	T94: 68
GPT	T60: 52, 44		

Connection version 2

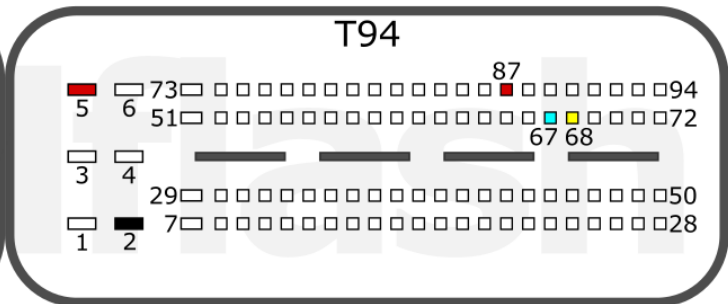
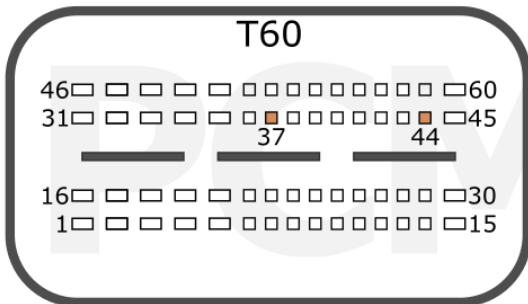

+12V	T94: 5, 87	CAN-L	T94: 67
GND	T94: 2	CAN-H	T94: 68
GPT	T60: 37, 44		

K/H

VAG

pcmflash.ru

v.1

2021-10-12

PCMflash

Engine Control Unit

EDC17CP15 TC1796

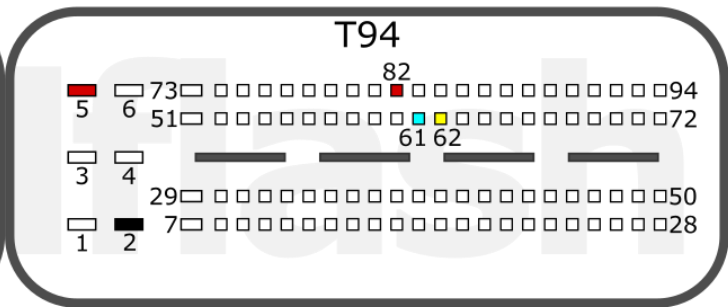
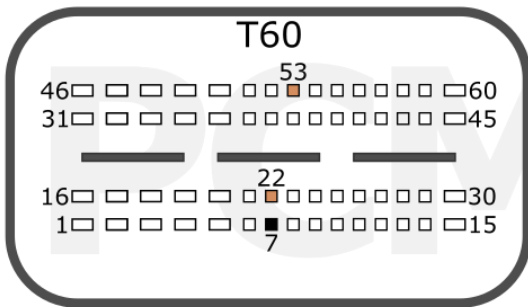

+12V	T94: 5, 82	CAN-L	T94: 61
GND	T60: 7, T94: 2	CAN-H	T94: 62
GPT	T60: 53, 22*		
* 10-50uF capacitor may be required			

MITSUBISHI

pcmflash.ru

v.1

2021-10-14

PCMflash

Engine Control Unit

EDC17CP16 TC1796

Connection version 1

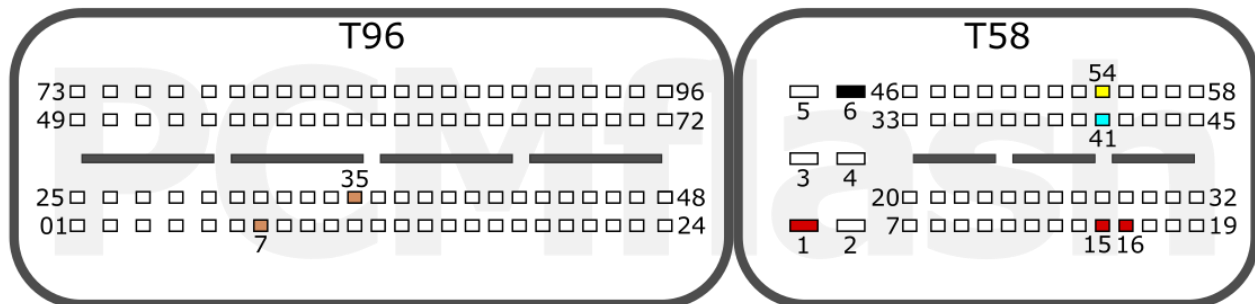

+12V	T58: 1, 15, 16	CAN-L	T58: 41
GND	T58: 6	CAN-H	T58: 54
GPT	T96: 7, 35		

Connection version 2



+12V	T58: 1, 15, 16	CAN-L	T58: 41
GND	T58: 4, 6	CAN-H	T58: 54
GPT	T96: 39, 35		

HONDA

pcmflash.ru

v.2

2021-02-28

PCMflash

Engine Control Unit

EDC17CP18 TC1796

J2

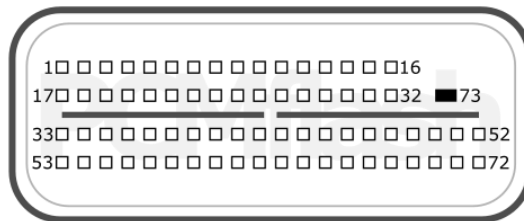

J1

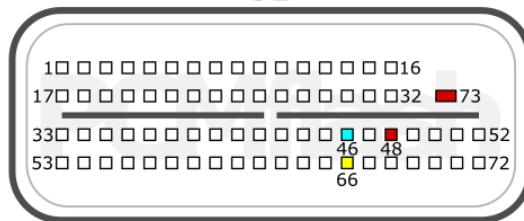

J3

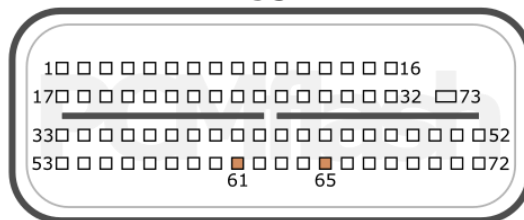

+12V	J1: 73, 48	CAN-L	J1: 46
GND	J2: 73	CAN-H	J1: 66
GPT	J3: 61, 65		

GM

pcmflash.ru

v.1

2021-11-26

PCMflash

Engine Control Unit

EDC17CP19 TC1766

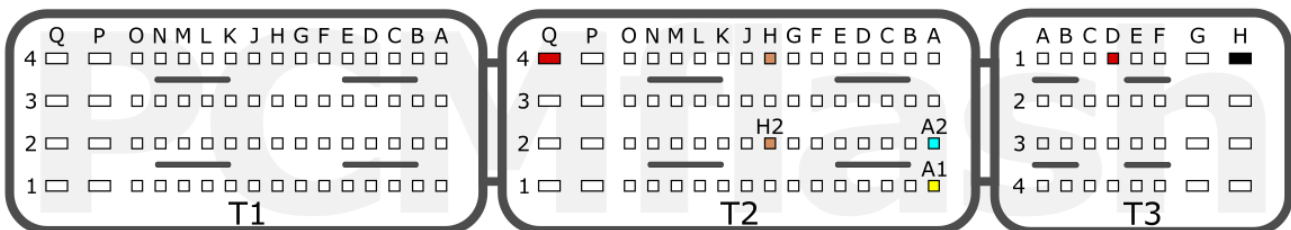

+12V	T2: Q4, T3:D1	CAN-L	T2: A2
GND	T3: H1	CAN-H	T2: A1
GPT	T2: H2, H4		

RENAULT

pcmflash.ru

v.2

2023-01-22

PCMflash

Engine Control Unit

EDC17CP22 TC1796

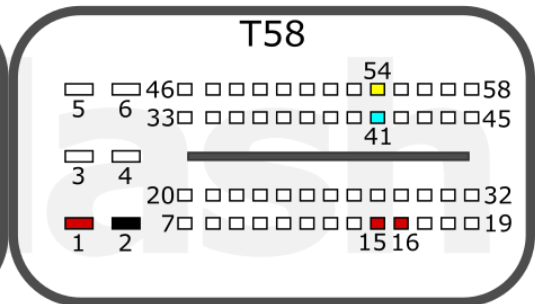
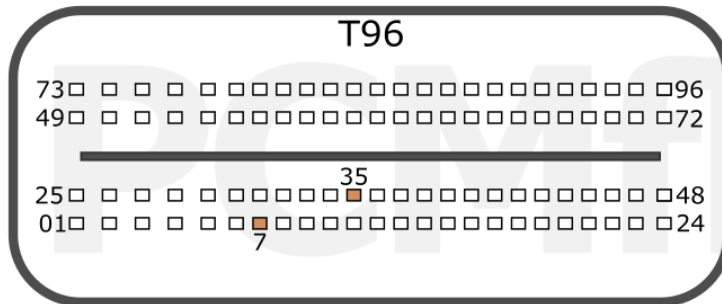

+12V	T58: 1, 15, 16	CAN-L	T58: 41
GND	T58: 2	CAN-H	T58: 54
GPT	T96: 35, 7		

VOLVO

pcmflash.ru

v.1

2021-09-09

PCMflash

Engine Control Unit

EDC17CP27 TC1796

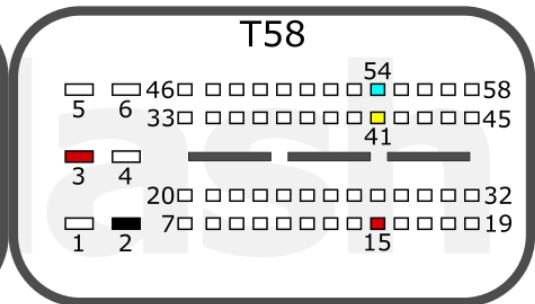
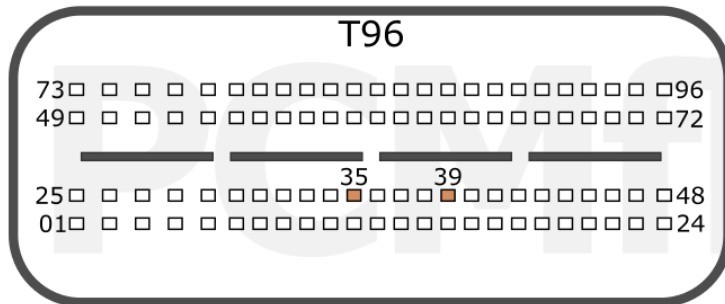

+12V	T58: 3, 15	CAN-L	T58: 54
GND	T58: 2	CAN-H	T58: 41
GPT	T96: 35, 39		

JEEP

pcmflash.ru

v.1

2021-10-13

PCMflash

Engine Control Unit

EDC17CP37 TC1766

Connection version 1



+12V	T1: 4, 61, 77	CAN-L	T1: 80
GND	T1: 2	CAN-H	T1: 81
GPT	T2: 98, 106		

Connection version 2



+12V	T1: 4, 61, 77	CAN-L	T1: 80
GND	T1: 2	CAN-H	T1: 81
GPT	T1: 59, 73		

TOYOTA

pcmflash.ru

v.2

2023-02-18

PCMflash

Engine Control Unit

EDC17CP42 TC1797

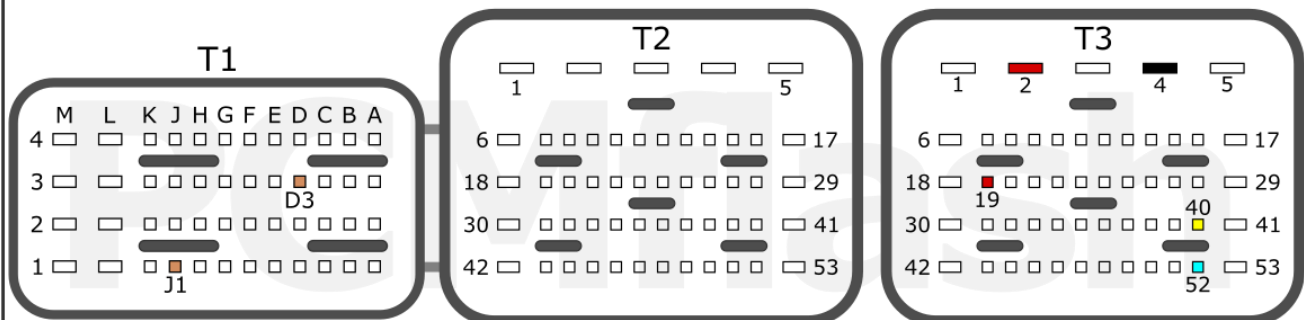

+12V	T3: 2, 19	CAN-L	T3: 52
GND	T3: 4	CAN-H	T3: 40
GPT	T1: D3, J1		

JLR

pcmflash.ru

v.1

2021-09-09

PCMflash

Engine Control Unit

EDC17CP44 TC1797

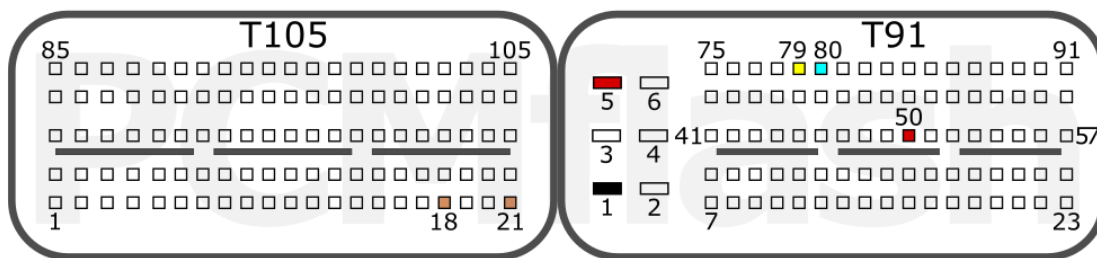

+12V	T91: 5, 50	CAN-L	T91: 80
GND	T91: 1	CAN-H	T91: 79
GPT	T105: 18, 21		

VAG

pcmflash.ru

v.1

2021-08-25

PCMflash

Engine Control Unit

EDC17CP45 TC1797

DME8 E71

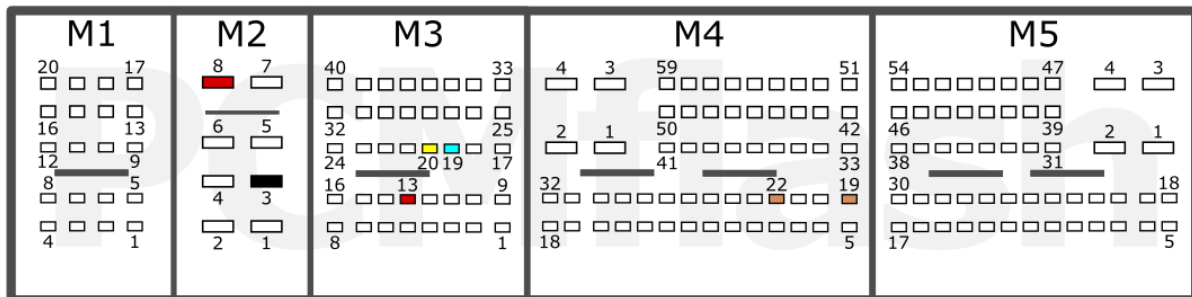

+12V	M2: 8, M3: 13	CAN-L	M3: 19
GND	M2: 3	CAN-H	M3: 20
GPT	M4: 22, 19		

F10

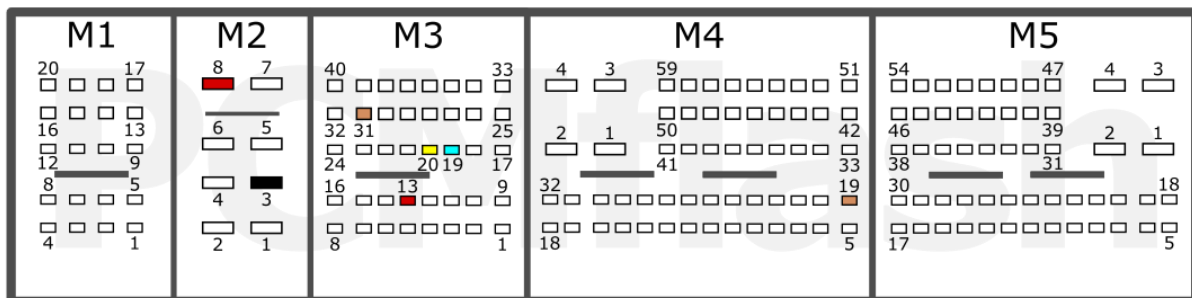

+12V	M2: 8, M3: 13	CAN-L	M3: 19
GND	M2: 3	CAN-H	M3: 20
GPT	M3: 31, M4: 19		

BMW

pcmflash.ru

v.1

2021-08-26

PCMflash

Engine Control Unit

EDC17CP48 TC1797

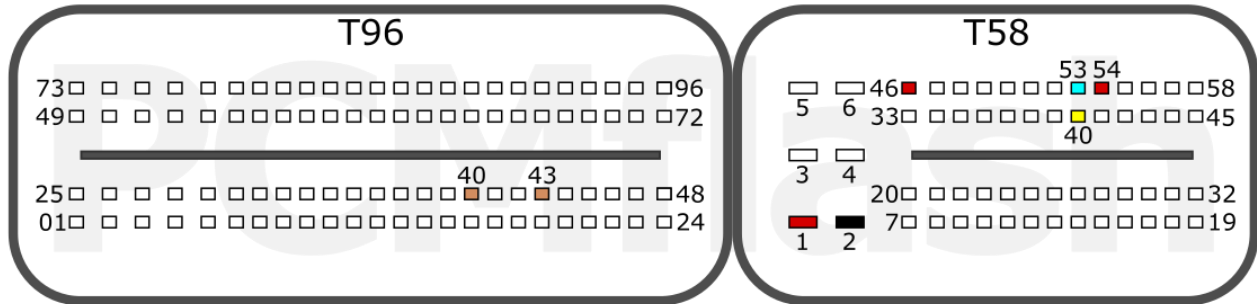

+12V	T58: 1, 46, 54	CAN-L	T58: 53
GND	T58: 2	CAN-H	T58: 40
GPT	T96: 43, 40		

VOLVO

pcmflash.ru

v.1

2021-10-09

PCMflash

Engine Control Unit

EDC17CP49 TC1797



+12V	T58: 1, 18	CAN-L	T58: 55
GND	T58: 2	CAN-H	T58: 56
GPT	T96: 92, 89		

BMW

pcmflash.ru

v.1

2021-10-03

PCMflash

Engine Control Unit

EDC17CP52 TC1797

Connection version 1

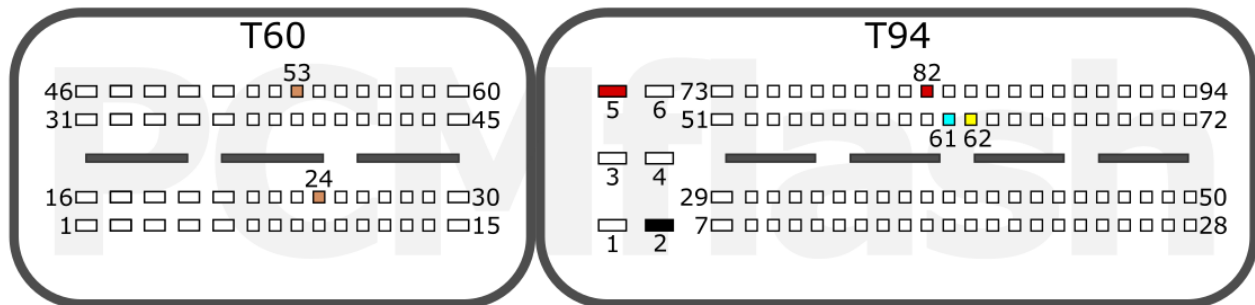

+12V	T94: 5, 82	CAN-L	T94: 61
GND	T94: 2	CAN-H	T94: 62
GPT	T60: 24, 53		

Connection version 2

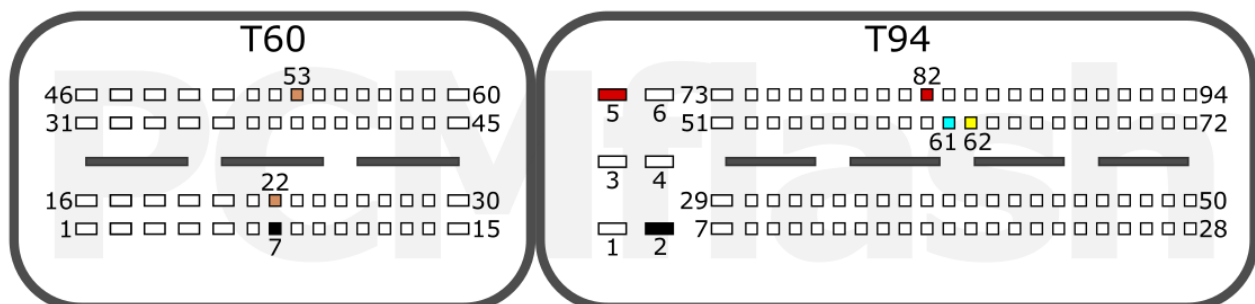

+12V	T94: 5, 82	CAN-L	T94: 61
GND	T60: 7, T94: 2	CAN-H	T94: 62
GPT	T60: 53, 22*		

*10-47 uF 50v capacitor required on 22 GPT line /
Подключить сигнал 22 GPT к ЭБУ через конденсатор 10-47 мкФ

FIAT

IVECO

MITSUBISHI

pcmflash.ru

v.3

2023-03-27

PCMflash

Engine Control Unit

EDC17CP54 TC1793

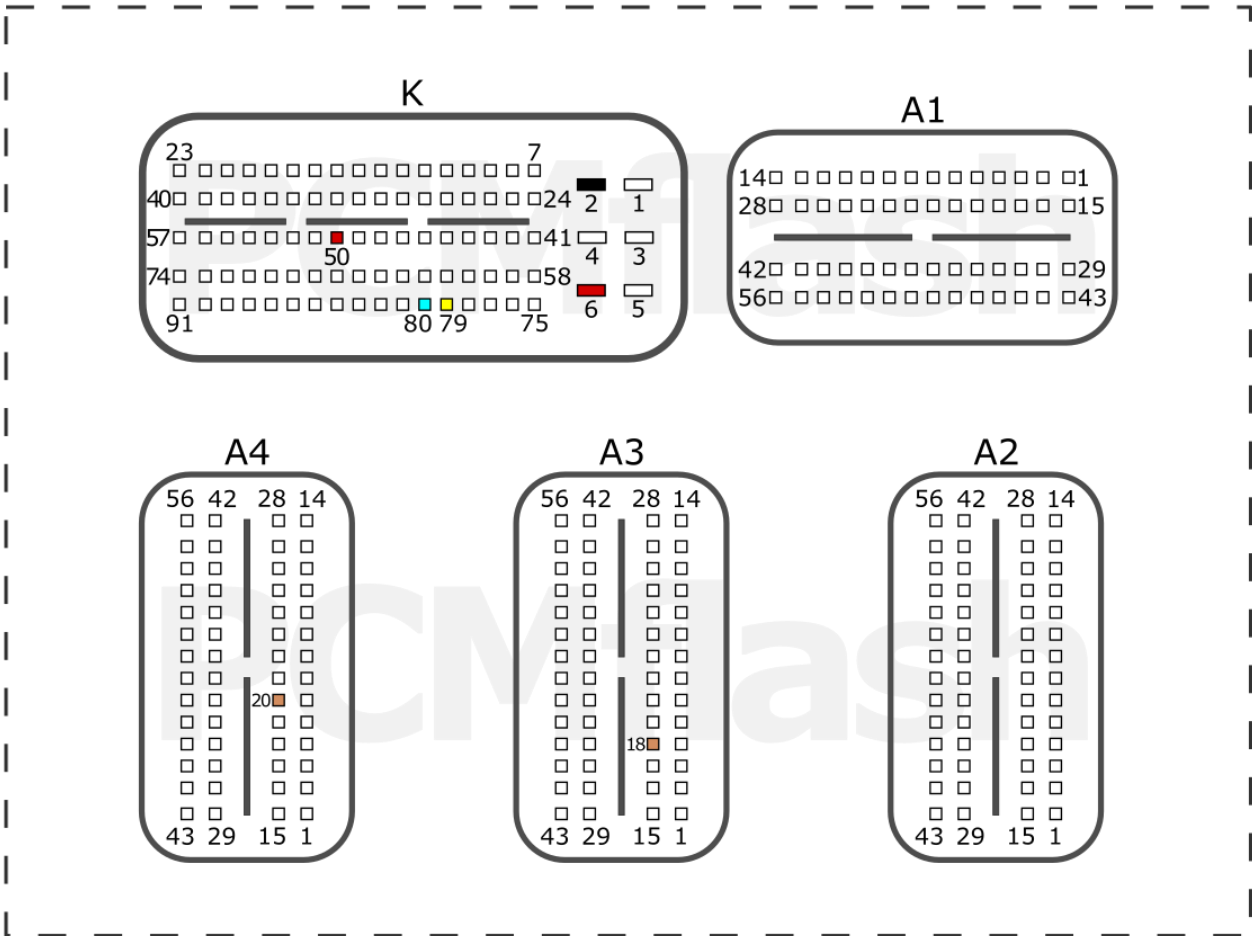

+12V	K: 6, 50	CAN-L	K: 80
GND	K: 2	CAN-H	K: 79
GPT	A3: 18, A4: 20		

AMAROK

pcmflash.ru

v.1

2022-12-21

PCMflash

Engine Control Unit

EDC17CP54 TC1793

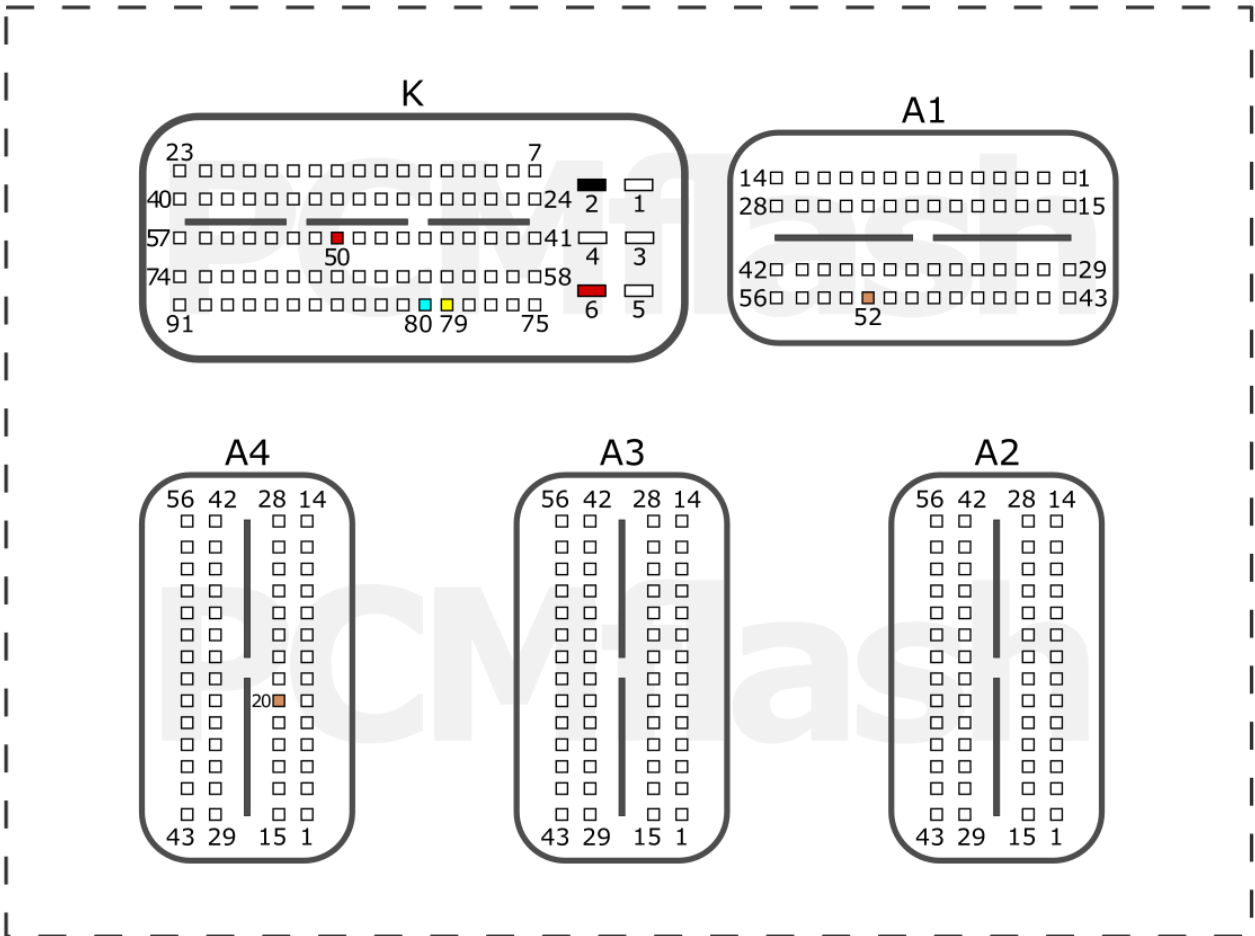

+12V	K: 6, 50	CAN-L	K: 80
GND	K: 2	CAN-H	K: 79
GPT	A4: 20, A1: 52		

AUDI

pcmflash.ru

v.1

2021-10-09

PCMflash

Engine Control Unit

EDC17CP55 TC1793

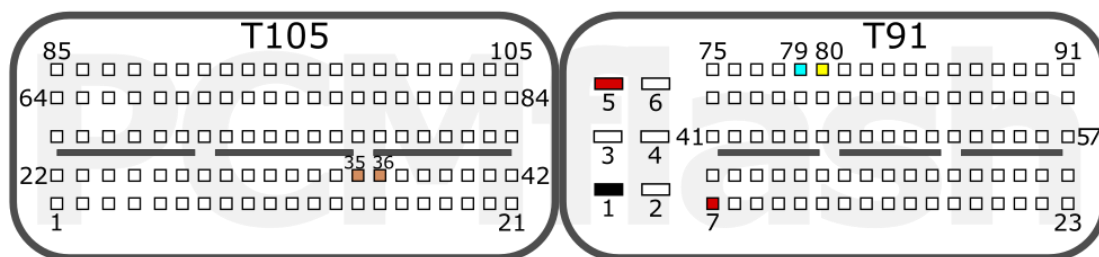

+12V	T91: 5, 7	CAN-L	T91: 79
GND	T91: 1	CAN-H	T91: 80
GPT	T105: 35, 36		

LAND ROVER

pcmflash.ru

v.2

2022-06-08

PCMflash

Engine Control Unit

EDC17CP57 TC1793

Connection version 1



+12V	T58: 3, 15	CAN-L	T58: 54
GND	T58: 2	CAN-H	T58: 41
GPT	T96: 35, 39		

Connection version 2

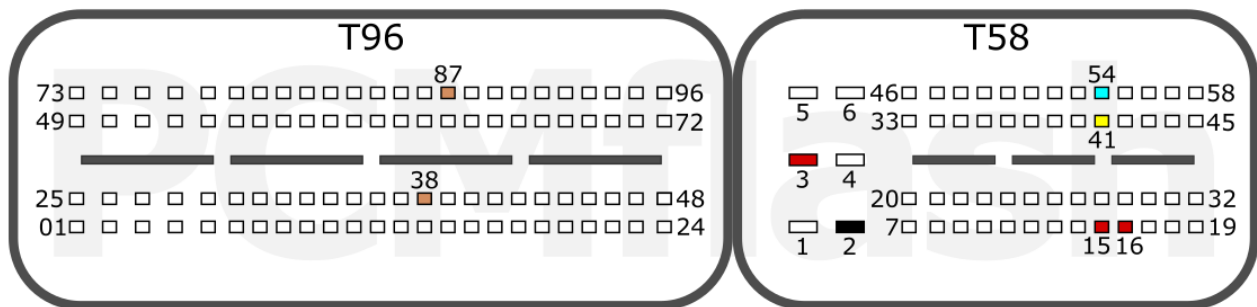

+12V	T58: 3, 15, 16	CAN-L	T58: 54
GND	T58: 2	CAN-H	T58: 41
GPT	T96: 87, 38		

MB

pcmflash.ru

v.1

2021-10-11

PCMflash

Engine Control Unit

EDC17CP58 TC1767

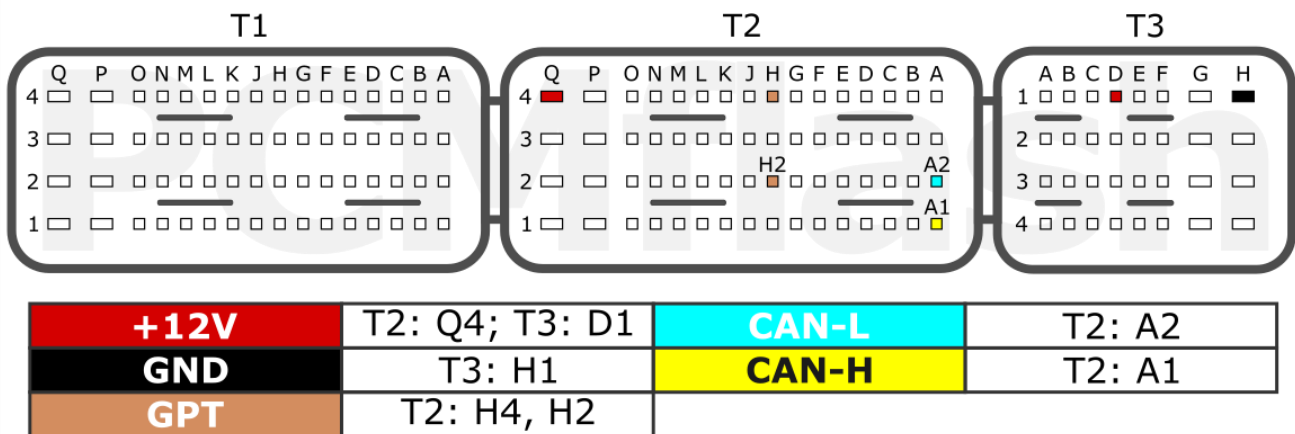

RENAULT

pcmflash.ru

v.1

2023-09-10

PCMflash

Engine Control Unit

EDC17CP60 TC1793

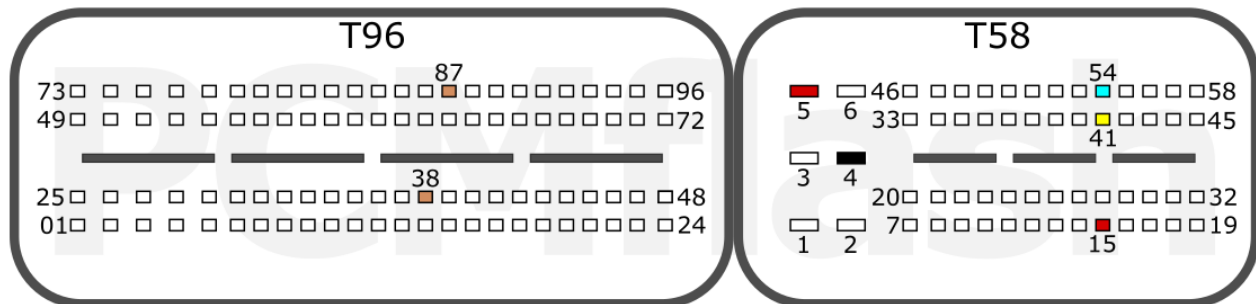

+12V	T58: 5, 15	CAN-L	T58: 54
GND	T58: 4	CAN-H	T58: 41
GPT	T96: 87, 38		

MB

pcmflash.ru

v.1

2023-05-21

PCMflash

Engine Control Unit

EDC17CP62 TC1793

T105

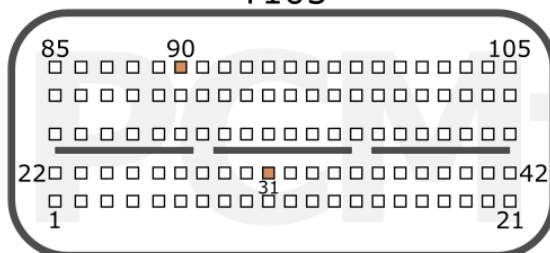

T91

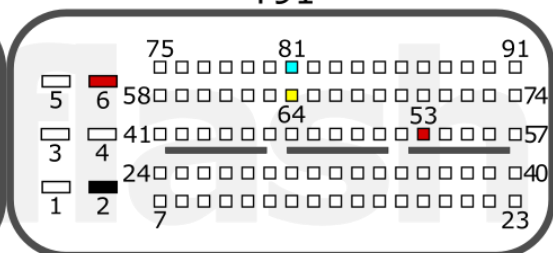

+12V	T91: 6, 53	CAN-L	T91: 81
GND	T91: 2	CAN-H	T91: 64
GPT	T105: 31, 90		

K/H

pcmflash.ru

v.1

2022-02-03

PCMflash

Engine Control Unit

EDC17CP65 TC1793

T1

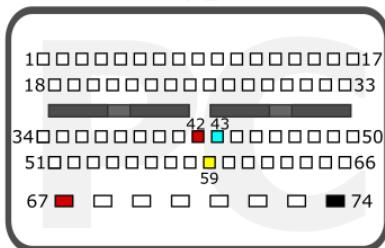

T2

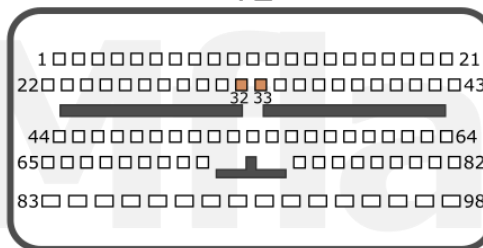

T3

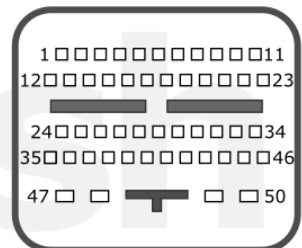

+12V	T1: 42, 67	CAN-L	T1: 43
GND	T1: 74	CAN-H	T1: 59
GPT	T2: 32, 33		

FORD

pcmflash.ru

v.2

2022-08-09

PCMflash

Engine Control Unit

EDC17CP74 TC1793

T105

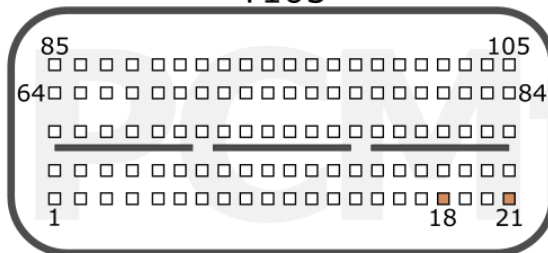

T91

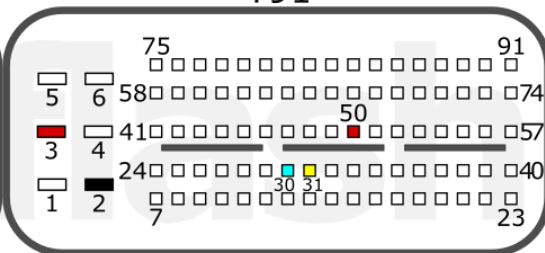

+12V	T91: 3, 50	CAN-L	T91: 30
GND	T91: 2	CAN-H	T91: 31
GPT	T105: 21, 18		

VAG

pcmflash.ru

v.1

2022-01-24

PCMflash

Engine Control Unit

EDC17CV41 TC1797

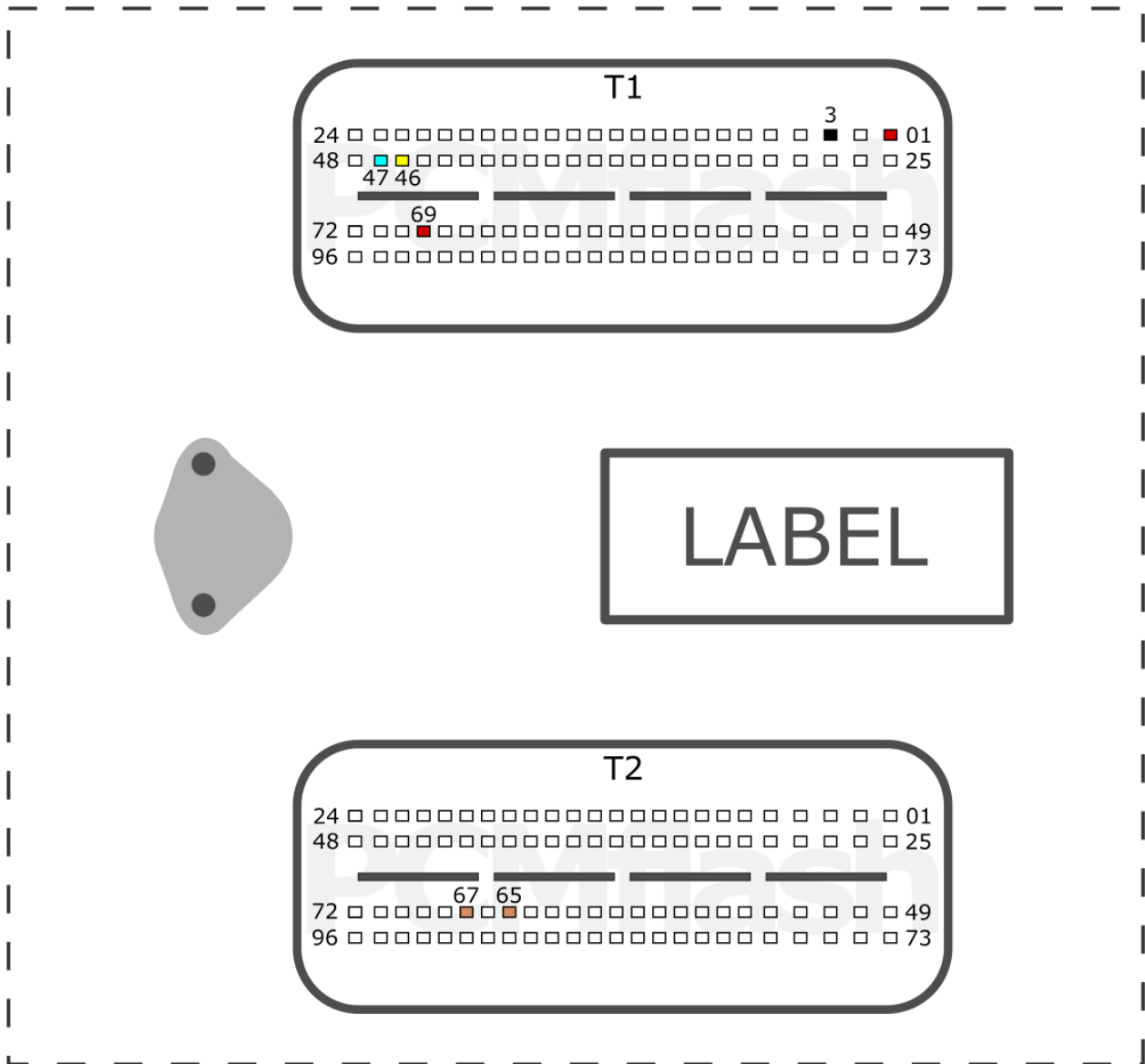

+12V	T1: 1, 69	CAN-L	T1: 47
GND	T1: 3	CAN-H	T1: 46
GPT	T2: 67, 65		

See next page/смотри следующую страницу

COMMERCIAL

PCMflash

Engine Control Unit

EDC17CV41 TC1797

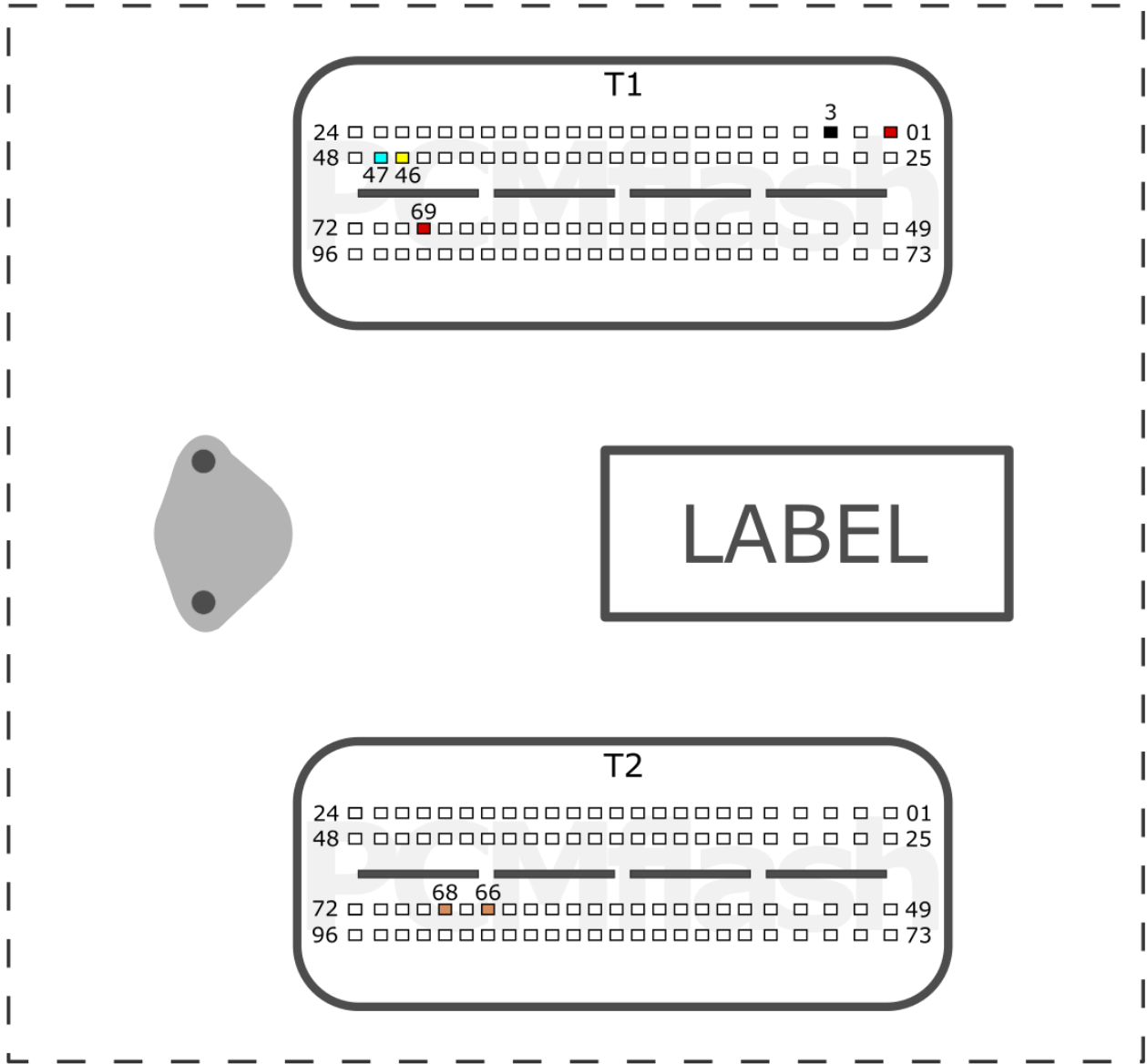

+12V	T1: 1, 69	CAN-L	T1: 47
GND	T1: 3	CAN-H	T1: 46
GPT	T2: 66, 68		

COMMERCIAL

pcmflash.ru

v.1

2023-04-22

PCMflash

Engine Control Unit

EDC17CV43/CV44 TC1767

Connection version 1

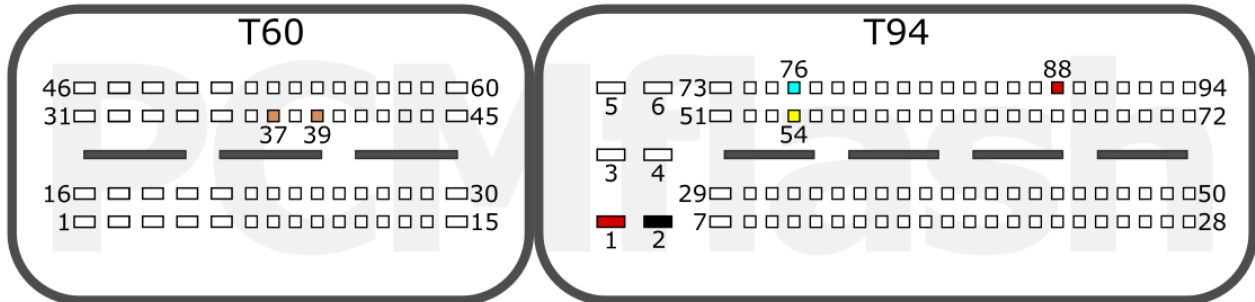

+12V	T94: 1, 88	CAN-L	T94: 76
GND	T94: 2	CAN-H	T94: 54
GPT	T60: 37, 39		

Connection version 2

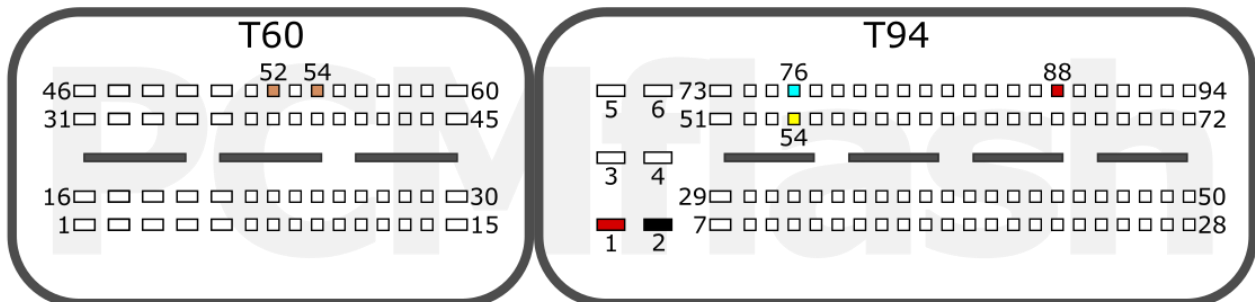

+12V	T94: 1, 88	CAN-L	T94: 76
GND	T94: 2	CAN-H	T94: 54
GPT	T60: 52, 54		

FAW

pcmflash.ru

v.3

2023-11-25

PCMflash

Engine Control Unit

EDC17CV45 TC1782

LABEL

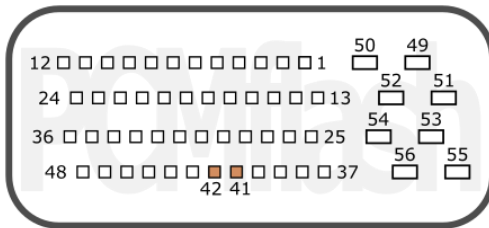

T1

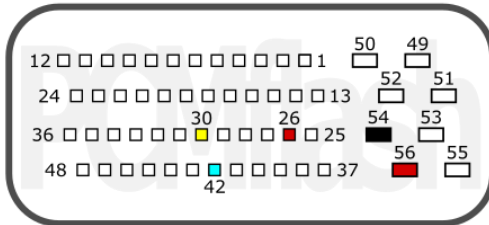

T2

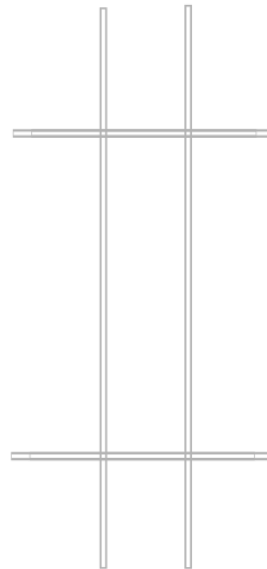

+12V	T2: 26, 56	CAN-L	T2: 42
GND	T2: 54	CAN-H	T2: 30
GPT	T1: 41, 42		

KUBOTA

pcmflash.ru

v.1

2024-05-27

PCMflash

Engine Control Unit

EDC17CV52 TC1797

T105

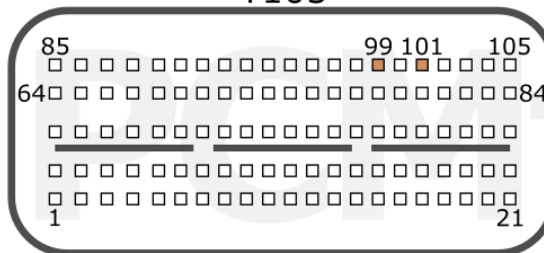

T91

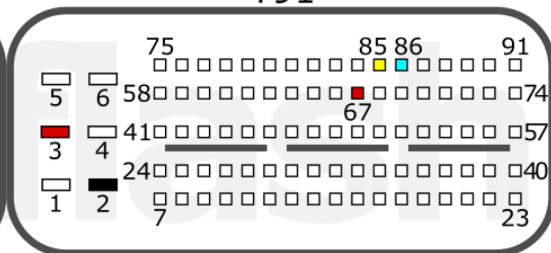

+12V	T91: 3, 67	CAN-L	T91: 86
GND	T91: 2	CAN-H	T91: 85
GPT	T105: 99, 101		

DEUTZ

pcmflash.ru

v.1

2021-10-12

PCMflash

Engine Control Unit

EDC17U05 TC1766

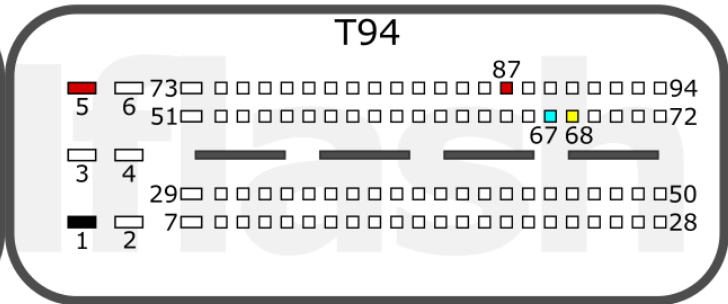
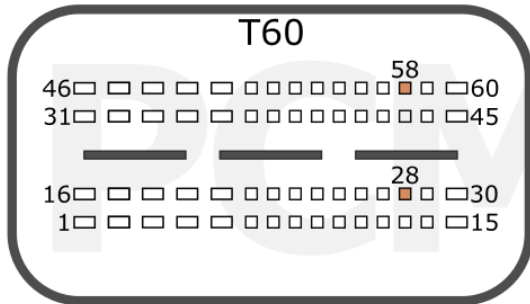

+12V	T94: 5, 87	CAN-L	T94: 67
GND	T94: 1	CAN-H	T94: 68
GPT	T60: 28, 58		

VAG

pcmflash.ru

v.1

2022-04-14

PCMflash

AdBlue Control Unit

DCU17CV51 TC1724

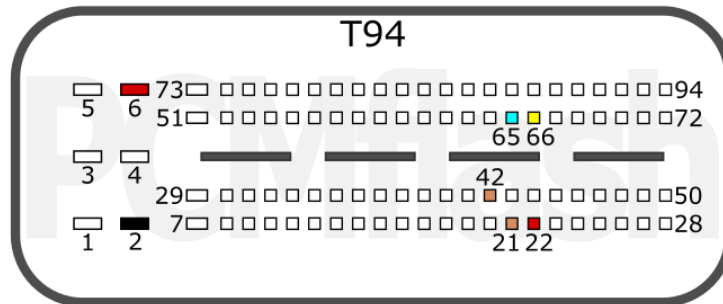

+12V	6, 22	CAN-L	65
GND	2	CAN-H	66
GPT	21, 42		

ALL

pcmflash.ru

v.1

2024-04-18

PCMflash

AdBlue Control Unit

DCU17HD01 TC1766

T86



T53

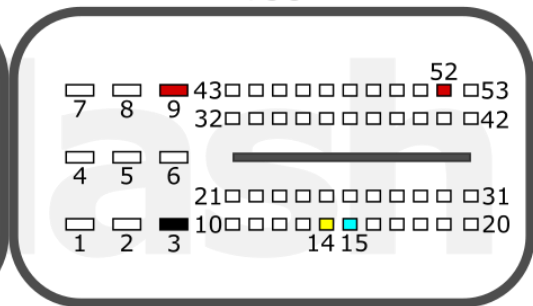

+12V	T53: 9, 52	CAN-L	T53: 15
GND	T53: 3	CAN-H	T53: 14
GPT	T86: 71, 51		

HINO

pcmflash.ru

v.2

2024-04-18

PCMflash

AdBlue Control Unit

DCU17PC01 TC1766

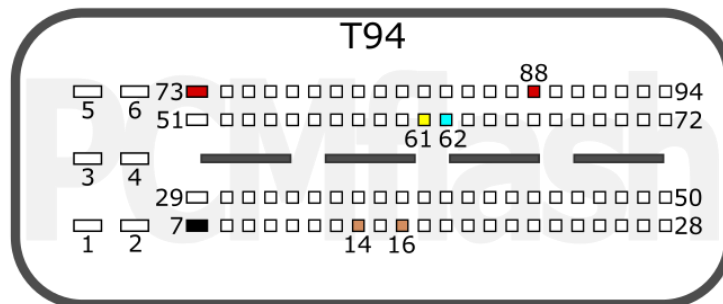

+12V	73, 88	CAN-L	62
GND	7	CAN-H	61
GPT	14, 16		

FORD

MB

pcmflash.ru

v.2

2024-04-18

PCMflash

AdBlue Control Unit

DCU17PC42/PC43 TC1724

Connection version 1

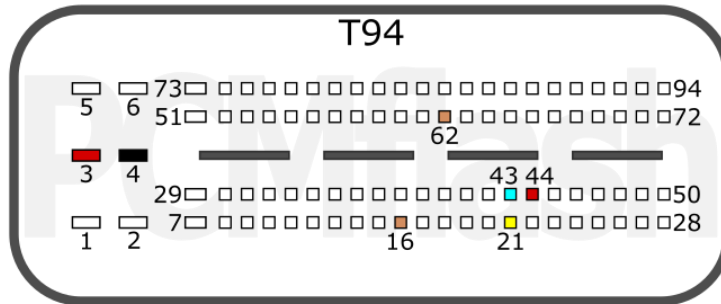

+12V	3, 44	CAN-L	43
GND	4	CAN-H	21
GPT	16, 62		

Connection version 2

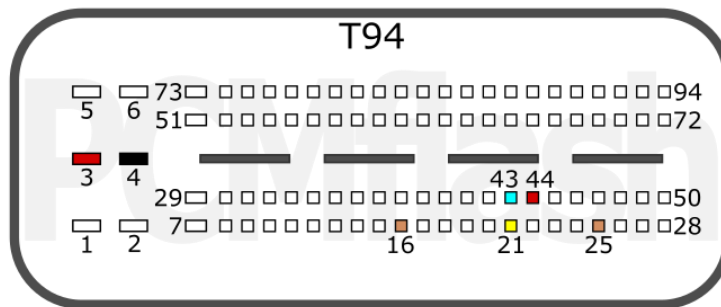

+12V	3, 44	CAN-L	43
GND	4	CAN-H	21
GPT	16, 25		

Connection version 3

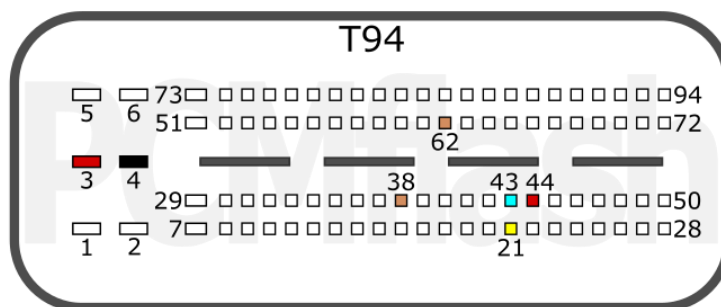

+12V	3, 44	CAN-L	43
GND	4	CAN-H	21
GPT	38, 62		