

PCMflash module 77

ME9/MED9/EDC7/EDC16/PSG16/TCU Bootloader

Contents/Оглавление

Contents/Оглавление.....	2
EDC7C1	4
EDC7C3	5
EDC7C4-6 (EDC16C31).....	6
EDC7C32	7
EDC7U1	8
EDC7UC31.....	9
EDC16C1	10
EDC16C2	11
EDC16C3	12
EDC16C4	13
EDC16C7	14
EDC16C8	15
EDC16C9	16
EDC16C10	17
EDC16C31	18
EDC16C32	19
EDC16C34	20
EDC16C35	21
EDC16C36	22
EDC16C37	23
EDC16C39	24
EDC16C41	26
EDC16C42	27
EDC16CP31	28
EDC16CP33	29
EDC16CP34	30
EDC16CP35	31
EDC16CP36	32
EDC16CP39	33
EDC16CP42	34
EDC16U1/U31/U34/CP34.....	35
EDC16UC40	36
ME9.0.....	37

MED9.1/MED9.1.1	38
MED9.5.10	39
ME9.6.....	40
MED9.6/ME(D)9.6.1	41
ME9.6.2	42
PSG16	43
6HPxx Bosch TCU	45
RE5RO5A 0260550002 TCU	46
RE5RO5A 0260550023 TCU	48
TC14 TCU.....	49

PCMflash

Engine Control Unit

EDC7C1

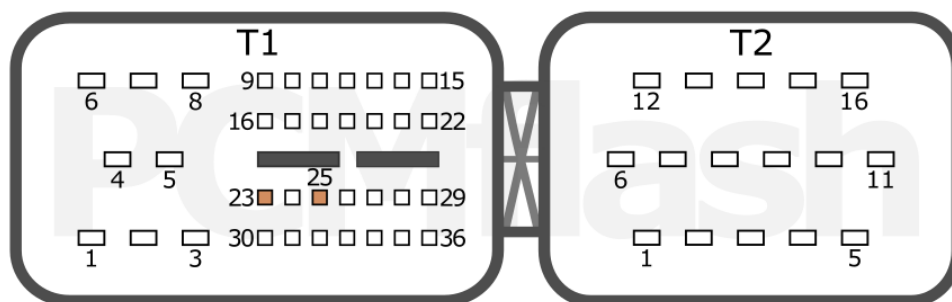

LABEL

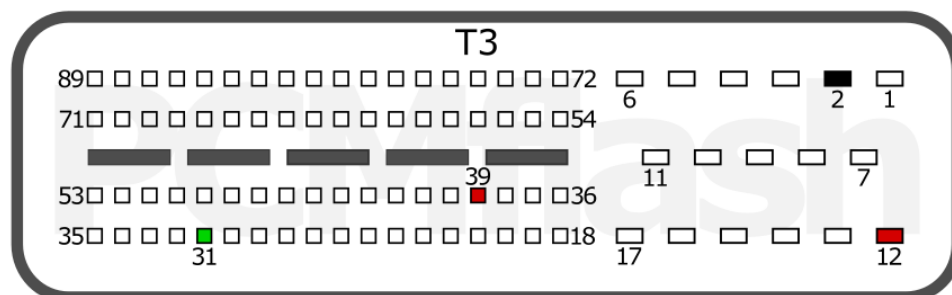

+12V	T3: 39, 12	GPT*	T1: 23, 25
GND	T3: 2	K-LINE	T3: 31
* Connect GPT signals to the ECU through 10-47uF capacitors / Подключить сигналы GPT к ЭБУ через конденсаторы 10-47мкФ			

BUS/TRUCK

pcmflash.ru

v.2

2023-03-26

PCMflash

Engine Control Unit

EDC7C3

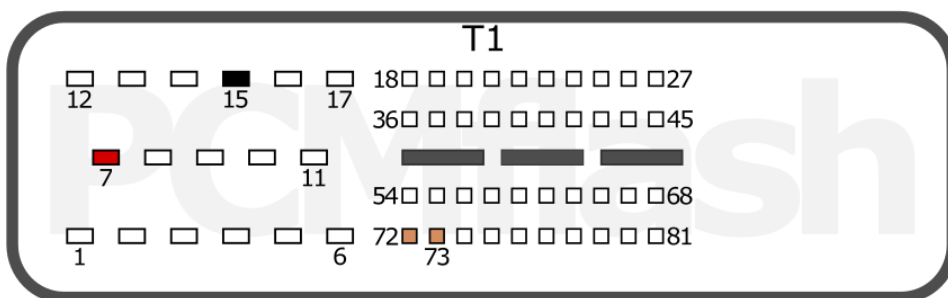

LABEL

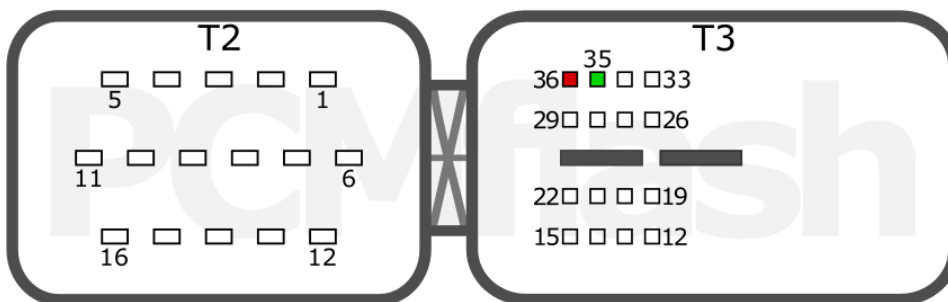

+12V	T1: 7, T3: 36	GPT*	T1: 72, 73
GND	T1: 15	K-LINE	T3: 35
<p>* Connect GPT signals to the ECU through 10-47uF capacitors / Подключить сигналы GPT к ЭБУ через конденсаторы 10-47мкФ</p>			

MAN

pcmflash.ru

v.2

2023-03-26

PCMflash

Engine Control Unit

EDC7C4-6 (EDC16C31)

T96

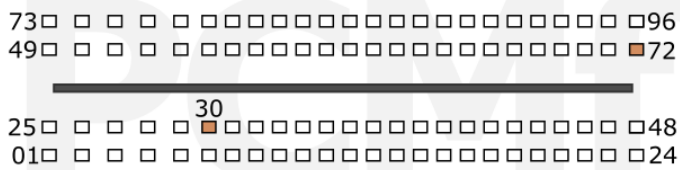

T58

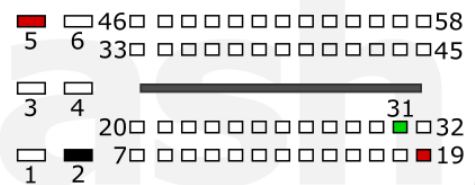

+12V	T58: 5, 19	GPT	T96: 30, 72
GND	T58: 2	K-LINE	T58: 31

MITSUBISHI

pcmflash.ru

v.1

2021-07-29

PCMflash

Engine Control Unit

EDC7C32

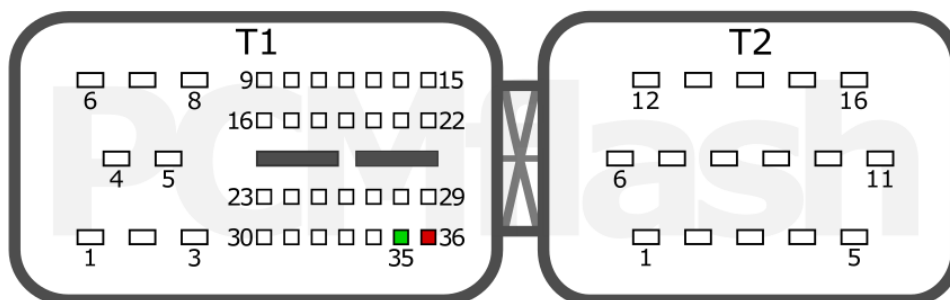

LABEL

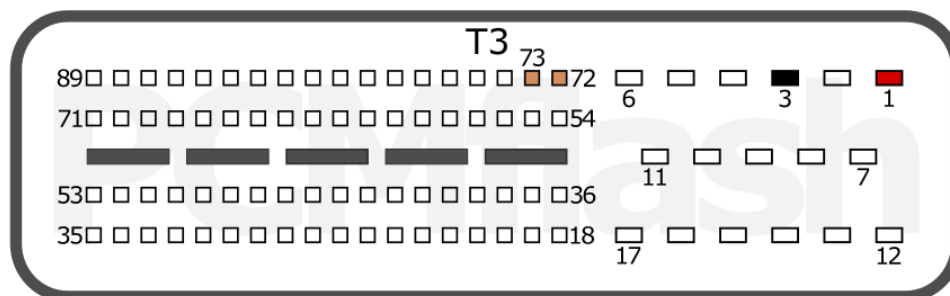

+12V	T1: 36, T3: 1	GPT*	T3: 72, 73
GND	T3: 3	K-LINE	T1: 35
* Connect GPT signals to the ECU through 10-47uF capacitors / Подключить сигналы GPT к ЭБУ через конденсаторы 10-47мкФ			

MAN

pcmflash.ru

v.2

2023-03-26

PCMflash

Engine Control Unit

EDC7UC31

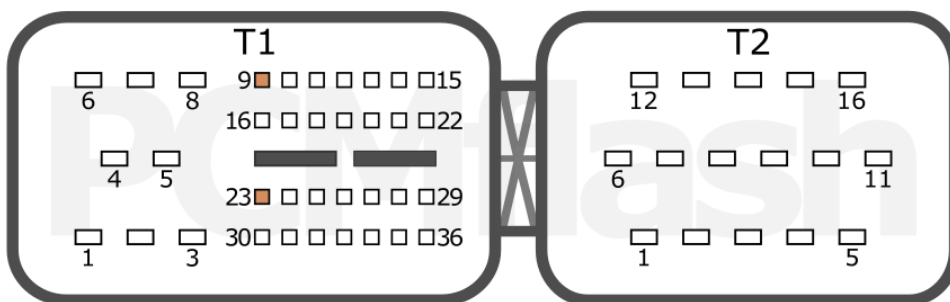

LABEL

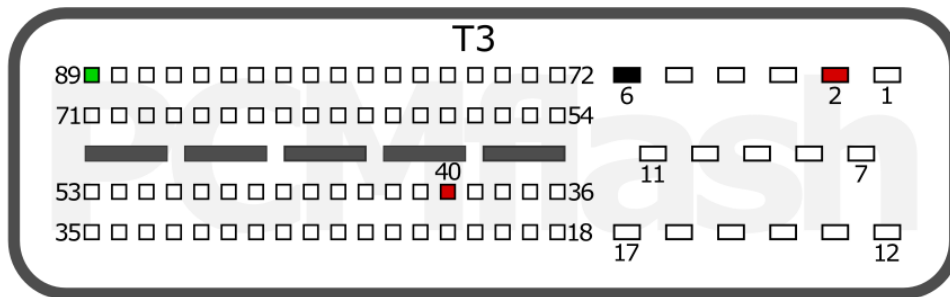

+12V	T3: 40, 2	GPT*	T1: 9, 23
GND	T3: 6	K-LINE	T3: 89
* Connect GPT signals to the ECU through 10-47uF capacitors / Подключить сигналы GPT к ЭБУ через конденсаторы 10-47мкФ			

BUS/TRUCK

pcmflash.ru

v.2

2023-03-26

PCMflash

Engine Control Unit

EDC16C3

NISSAN, RENAULT, SUZUKI

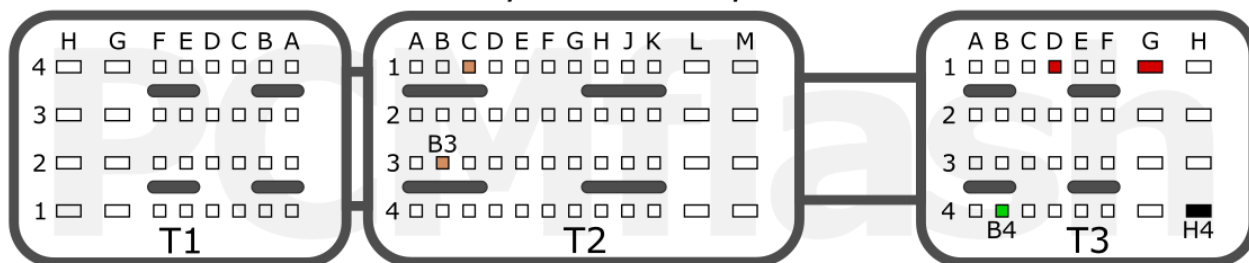

+12V	T3: D1, G1	GPT	T2: C1, B3
GND	T3: H4	K-LINE	T3: B4

NISSAN, RENAULT

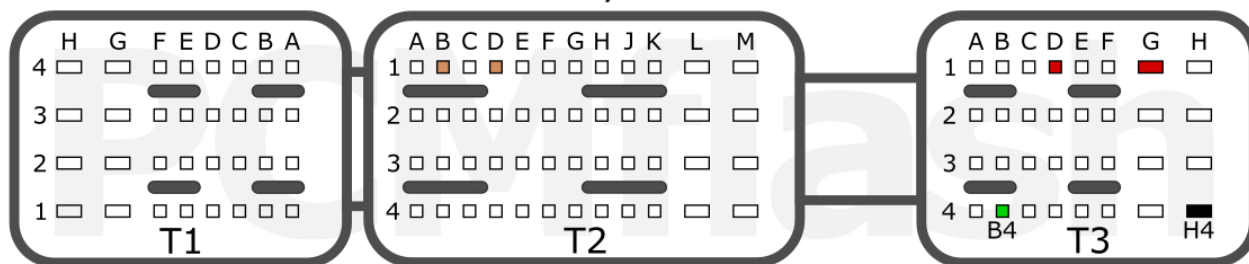

+12V	T3: D1, G1	GPT	T2: B1, D1
GND	T3: H4	K-LINE	T3: B4

PEUGEOT, MAZDA

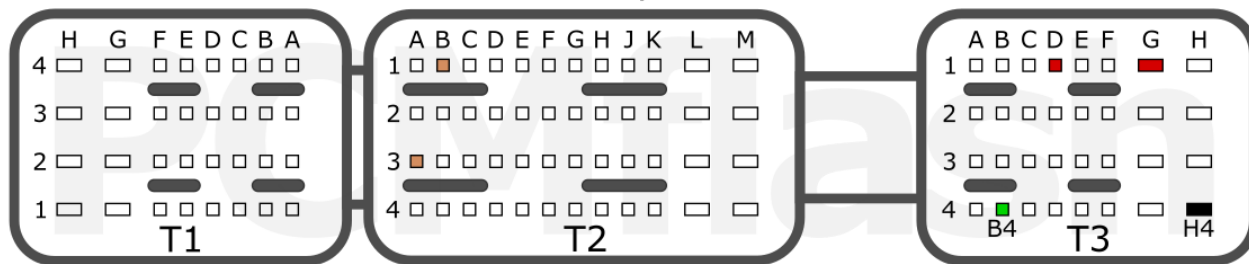

+12V	T3: D1, G1	GPT	T2: B1, A3
GND	T3: H4	K-LINE	T3: B4

MAZDA

NISSAN

PEUGEOT

RENAULT

SUZUKI

pcmflash.ru

v.1

2021-08-04

PCMflash

Engine Control Unit

EDC16C7

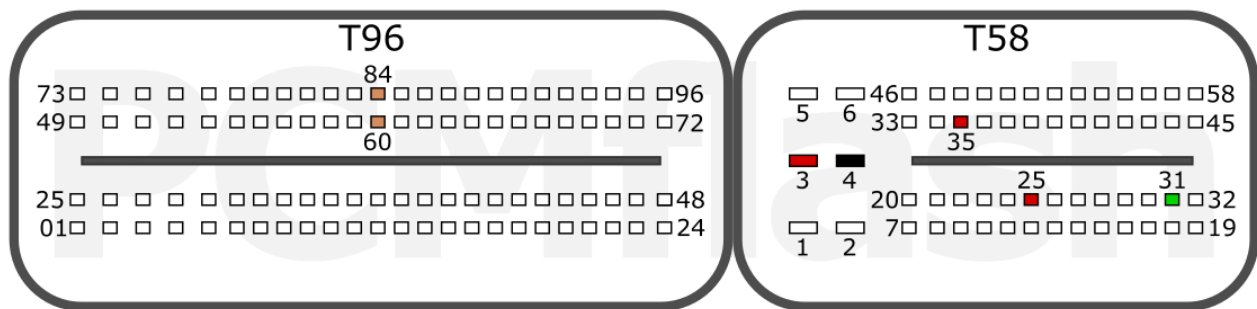

+12V	T58: 3, 35, 25	GPT	T96: 84, 60
GND	T58: 4	K-LINE	T58: 31

FORD

HONDA

MAZDA

pcmflash.ru

v.1

2021-07-21

PCMflash

Engine Control Unit

EDC16C9

Connection version 1

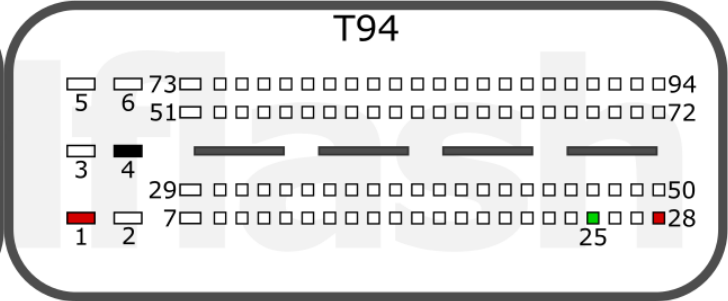
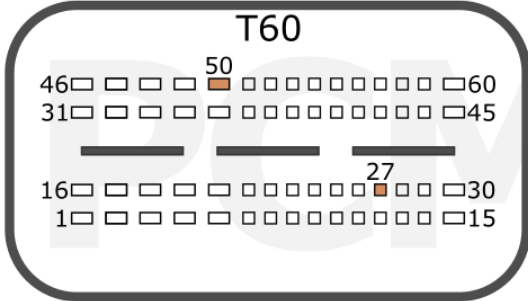

+12V	T94: 1, 28	GPT	T60: 50, 27
GND	T94: 4	K-LINE	T94: 25

Connection version 2

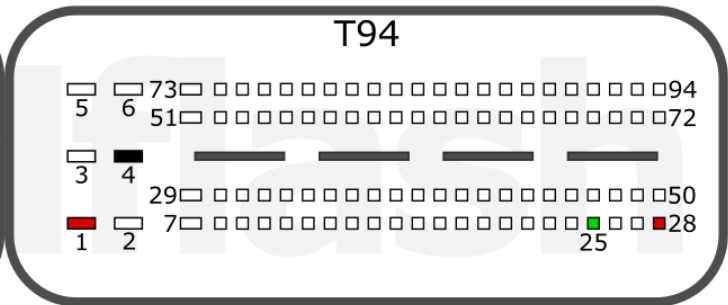
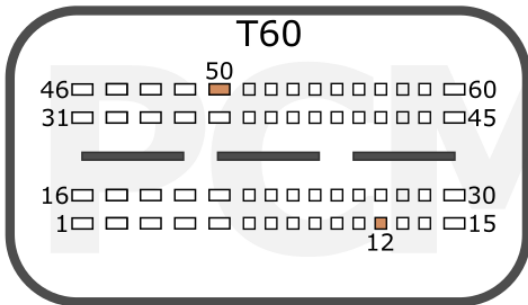

+12V	T94: 1, 28	GPT	T60: 50, 12
GND	T94: 4	K-LINE	T94: 25

Connection version 3

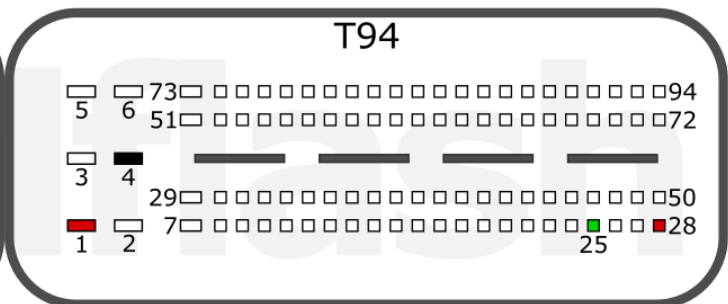
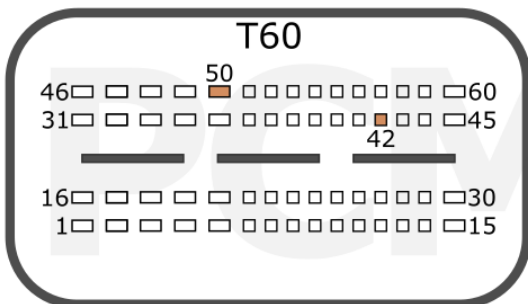

+12V	T94: 1, 28	GPT	T60: 50, 42
GND	T94: 4	K-LINE	T94: 25

GM

pcmflash.ru

v.2

2021-12-03

PCMflash

Engine Control Unit

EDC16C10



+12V	T1: 1, 17	GPT	T2: 107, 112
GND	T1: 3	K-LINE	T1: 79

TOYOTA

pcmflash.ru

v.2

2022-01-21

PCMflash

Engine Control Unit

EDC16C34

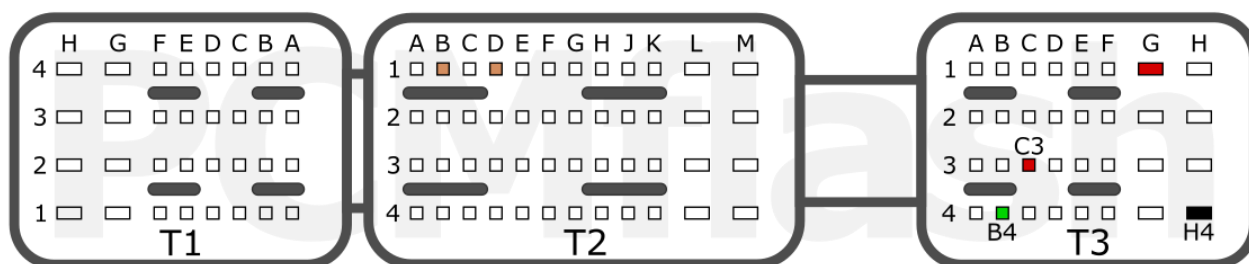

+12V	T3: G1, C3	GPT	T2: B1, D1
GND	T3: H4	K-LINE	T3: B4

FORD

PSA

VOLVO

pcmflash.ru

v.2

2023-07-22

PCMflash

Engine Control Unit

EDC16C36

Connection version 1

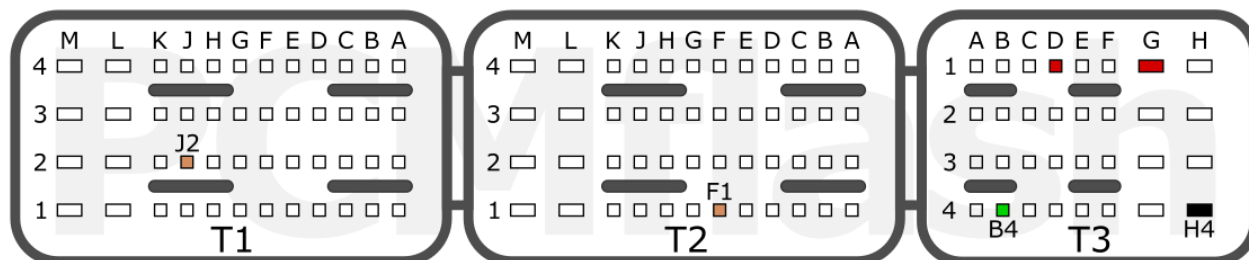

+12V	T3: D1, G1	GPT	T1: J2, T2:F1
GND	T3: H4	K-LINE	T3: B4

Connection version 2

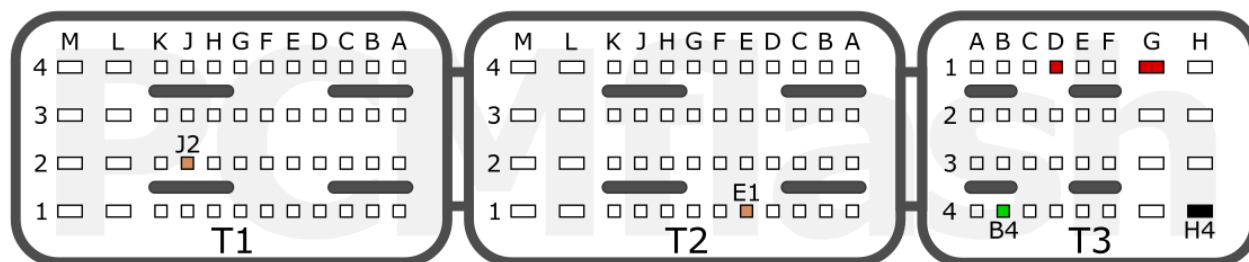

+12V	T3: D1, G1	GPT	T1: J2, T2:E1*
GND	T3: H4	K-LINE	T3: B4

*10-47 uF 50v capacitor required on E1 GPT line /
Подключить сигнал E1 GPT к ЭБУ через конденсатор 10-47 мкФ

Connection version 3

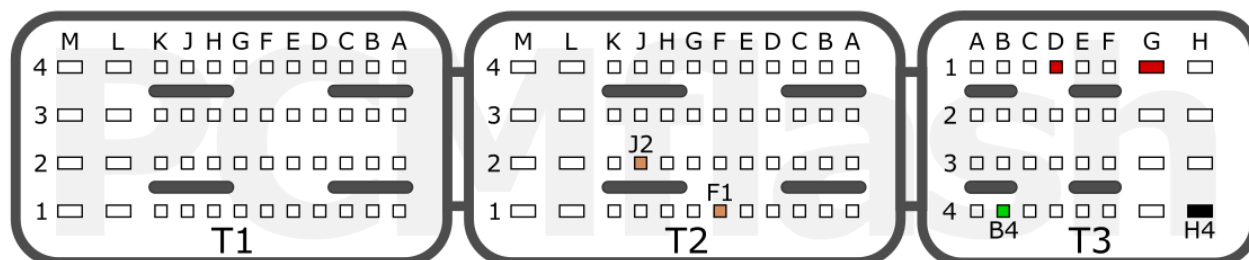

+12V	T3: D1, G1	GPT	T2: J2, F1
GND	T3: H4	K-LINE	T3: B4

RENAULT

pcmflash.ru

v.4

2023-03-26

PCMflash

Engine Control Unit

EDC16C37



+12V	T58: 5, 21	GPT	T96: 79, 5
GND	T58: 2	K-LINE	T58: 43

GM

pcmflash.ru

v.1

2021-11-03

PCMflash

Engine Control Unit

EDC16C39

CHEVROLET, FIAT, HYUNDAI, IVECO, KIA, UAZ

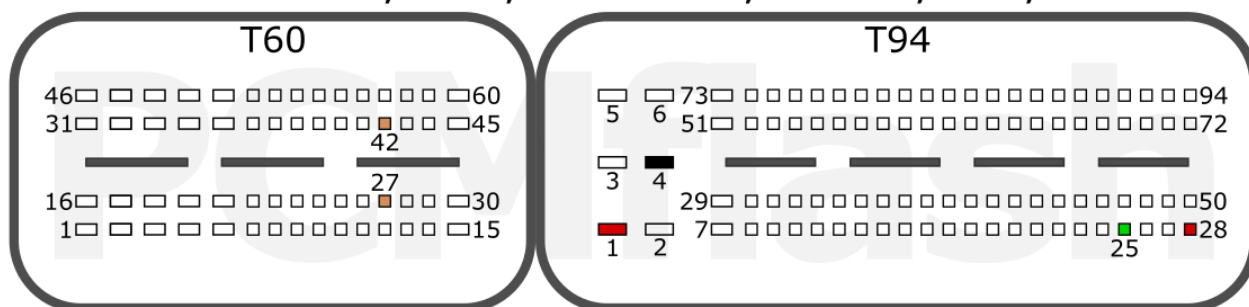

+12V	T94: 1, 28	GPT	T60: 42, 27
GND	T94: 4	K-LINE	T94: 25

CHEVROLET, HYUNDAI

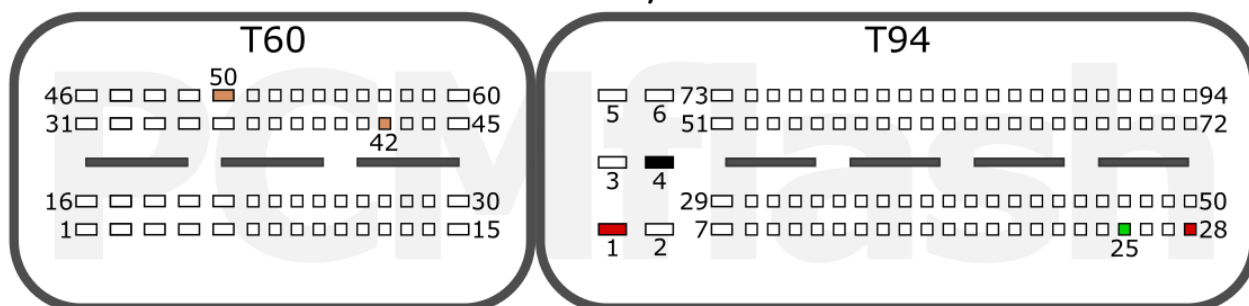

+12V	T94: 1, 28	GPT	T60: 50, 42
GND	T94: 4	K-LINE	T94: 25

See next page/смотри следующую страницу

CHEVROLET	FIAT	HYUNDAI	IVECO	KIA	UAZ
pcmflash.ru				v.2	2022-02-13

PCMflash

Engine Control Unit

EDC16C39

FIAT

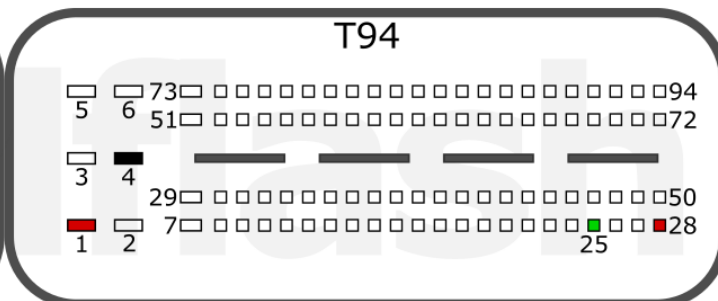
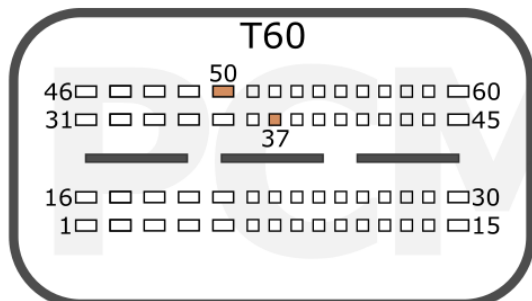

+12V	T94: 1, 28	GPT	T60: 50, 37
GND	T94: 4	K-LINE	T94: 25

OPEL, SAAB

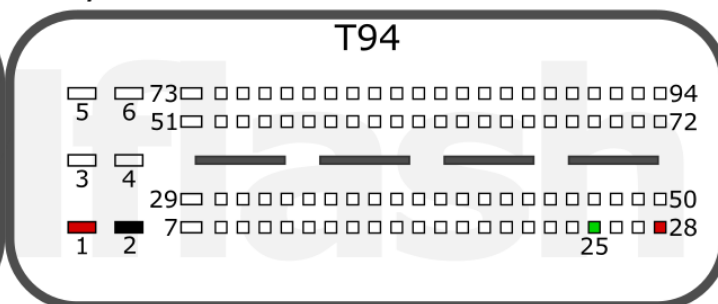
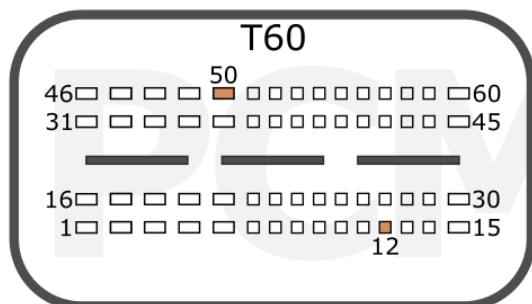

+12V	T94: 1, 28	GPT	T60: 50, 12
GND	T94: 2	K-LINE	T94: 25

SAAB

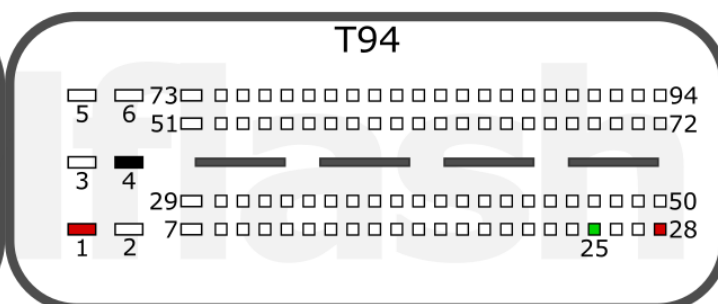
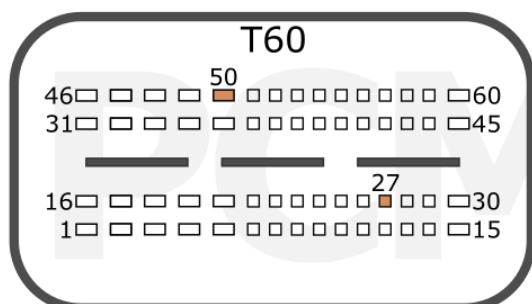

+12V	T94: 1, 28	GPT	T60: 50, 27
GND	T94: 4	K-LINE	T94: 25

FIAT

OPEL

SAAB

pcmflash.ru

v.3

2023-05-27

PCMflash

Engine Control Unit

EDC16CP31

Connection version 1

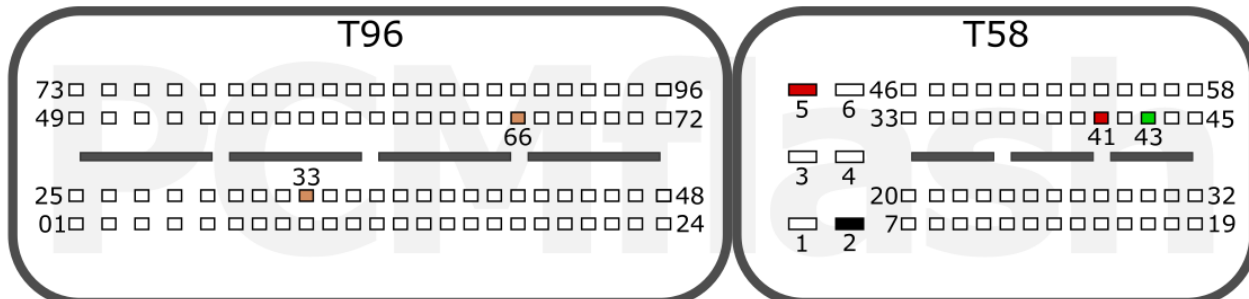

+12V	T58: 5, 41	GPT	T96: 33, 66
GND	T58: 2	K-LINE	T58: 43

Connection version 2

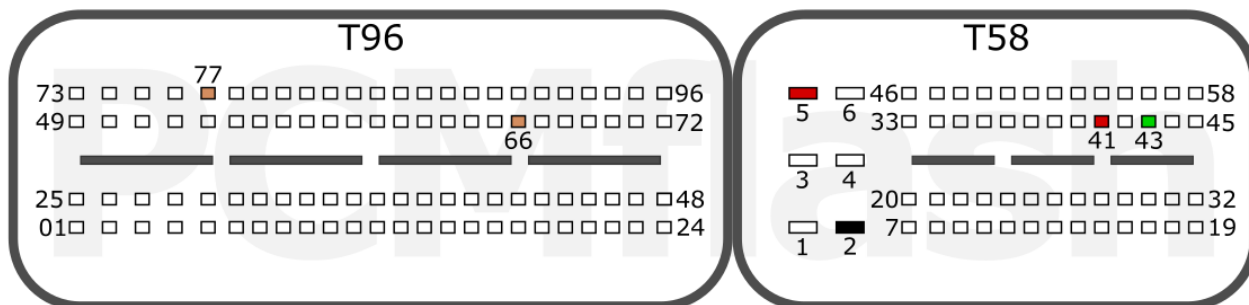

+12V	T58: 5, 41	GPT	T96: 77, 66
GND	T58: 2	K-LINE	T58: 43

Connection version 3

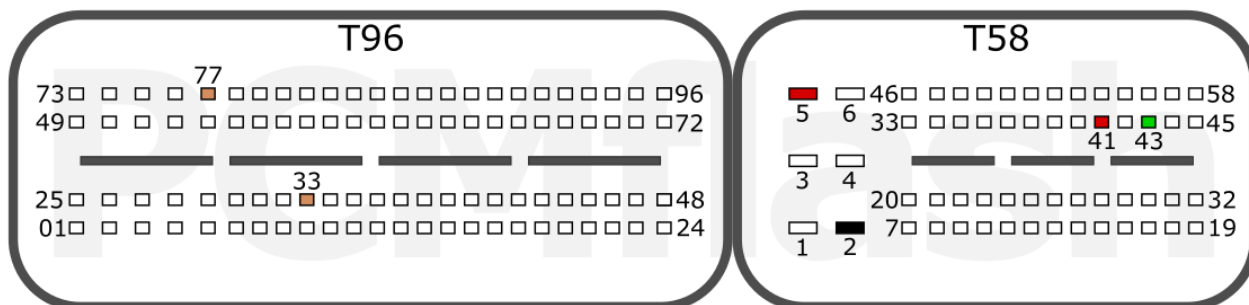

+12V	T58: 5, 41	GPT	T96: 33, 77
GND	T58: 2	K-LINE	T58: 43

DODGE

JEEP

MB

pcmflash.ru

v.3

2022-06-14

PCMflash

Engine Control Unit

EDC16CP33

NISSAN, RENAULT

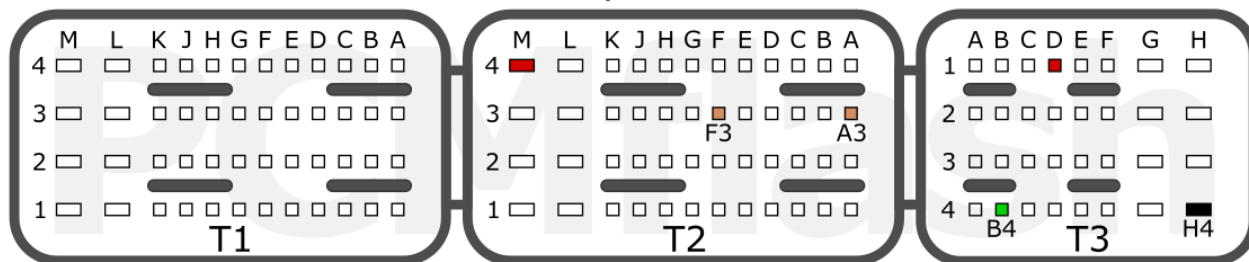

+12V	T2: M4, T3: D1	GPT	T2: F3, T2: A3
GND	T3: H4	K-LINE	T3: B4

RENAULT

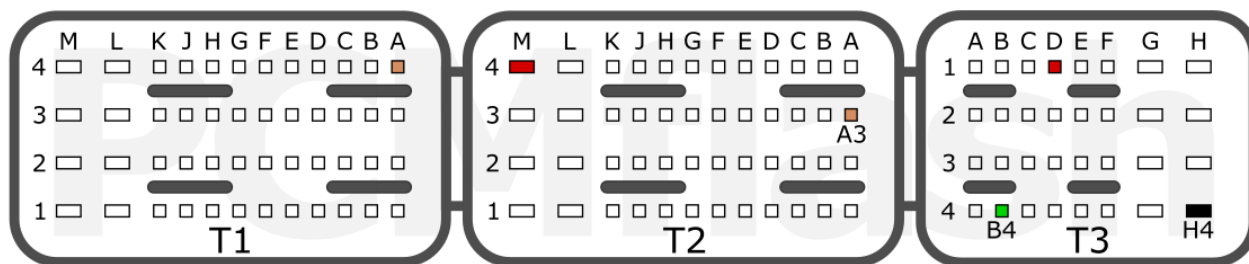

+12V	T2: M4, T3: D1	GPT	T1: A4, T2: A3
GND	T3: H4	K-LINE	T3: B4

NISSAN

RENAULT

pcmflash.ru

v.3

2022-04-04

PCMflash

Engine Control Unit

EDC16CP36



+12V	T58: 5, 15, 16	GPT	T96: 33, 77
GND	T58: 2	K-LINE	T58: 29

MB

pcmflash.ru

v.1

2021-08-08

PCMflash

Engine Control Unit

EDC16CP39

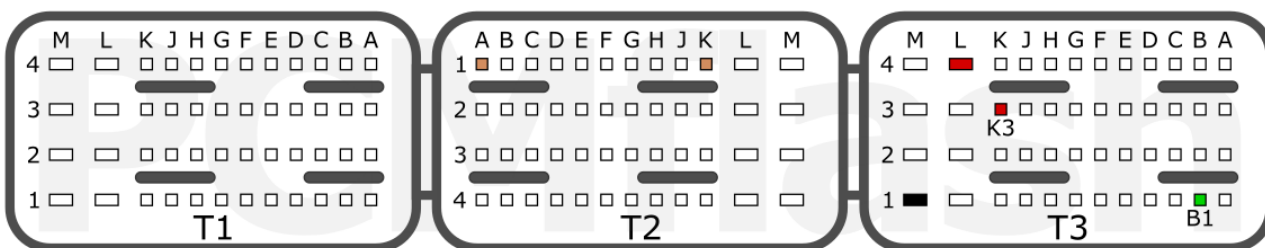

+12V	T3: L4, K3	GPT	T2: A1, K1
GND	T3: M1	K-LINE	T3: B1

FORD

JLR

pcmflash.ru

v.1

2021-08-06

PCMflash

Engine Control Unit

EDC16CP42

Connection version 1

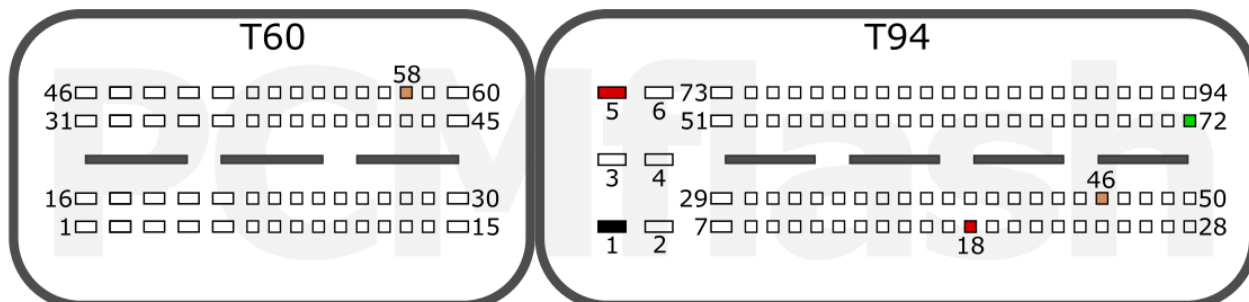

+12V	T94: 5, 18	GPT	T60: 58; T94: 46
GND	T94: 1	K-LINE	T94: 72

Connection version 2

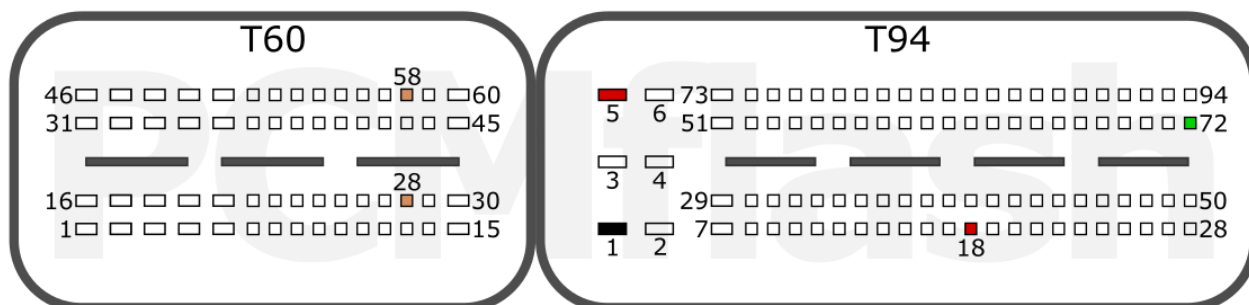

+12V	T94: 5, 18	GPT	T60: 58, 28
GND	T94: 1	K-LINE	T94: 72

Connection version 3

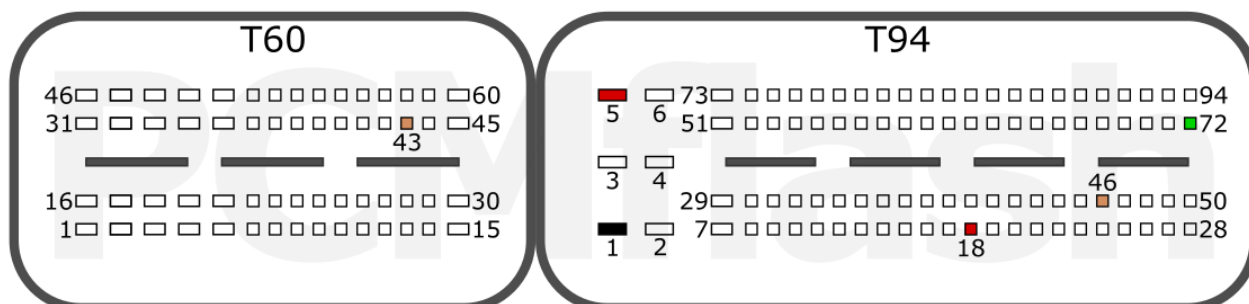

+12V	T94: 5, 18	GPT	T60: 43; T94: 46
GND	T94: 1	K-LINE	T94: 72

NISSAN

pcmflash.ru

v.2

2024-06-01

PCMflash

Engine Control Unit

EDC16UC40

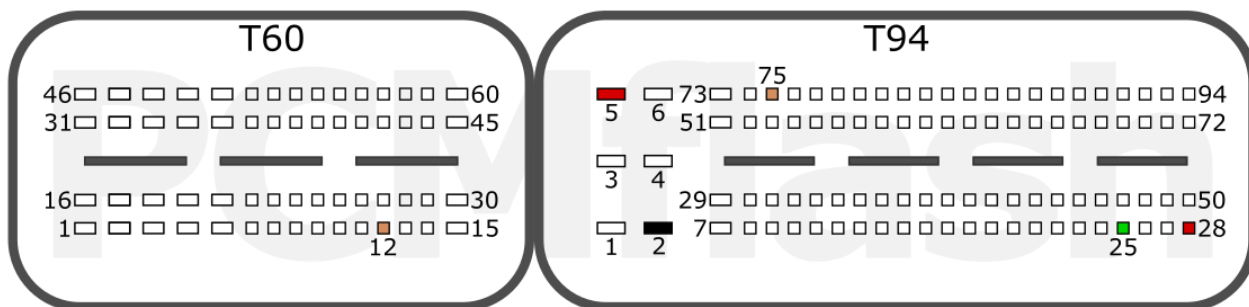

+12V	T94: 5, 28	GPT	T94: 75; T60: 12
GND	T94: 2	K-LINE	T94: 25

DEUTZ

pcmflash.ru

v.1

2024-05-10

PCMflash

Engine Control Unit

ME9.0

Connection version 1

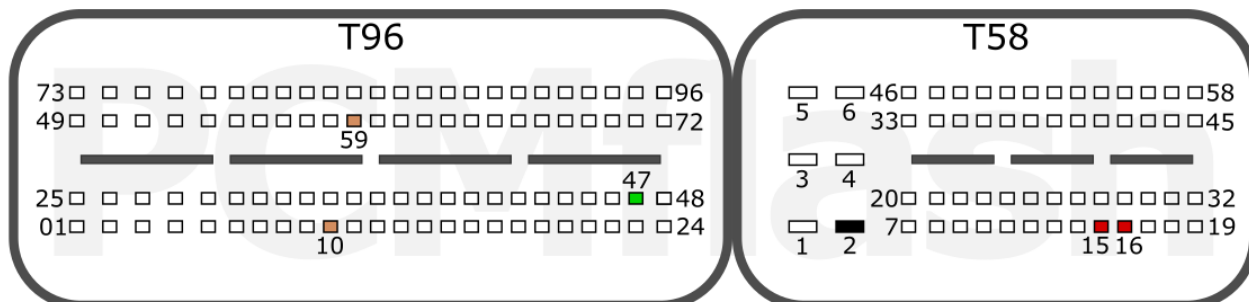

+12V	T58: 15, 16	GPT	T96: 59, 10
GND	T58: 2	K-LINE	T96: 47

Connection version 2

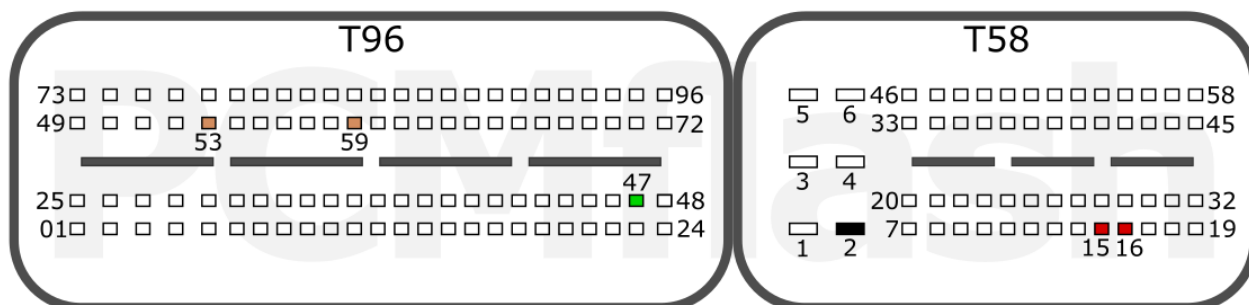

+12V	T58: 15, 16	GPT	T96: 59, 53
GND	T58: 2	K-LINE	T96: 47

Connection version 3

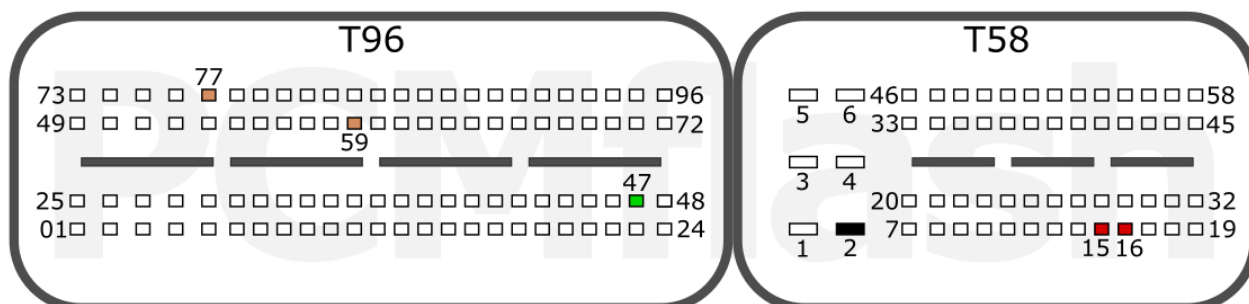

+12V	T58: 15, 16	GPT	T96: 59, 77
GND	T58: 2	K-LINE	T96: 47

VOLVO

pcmflash.ru

v.2

2021-11-03

PCMflash

Engine Control Unit

MED9.5.10

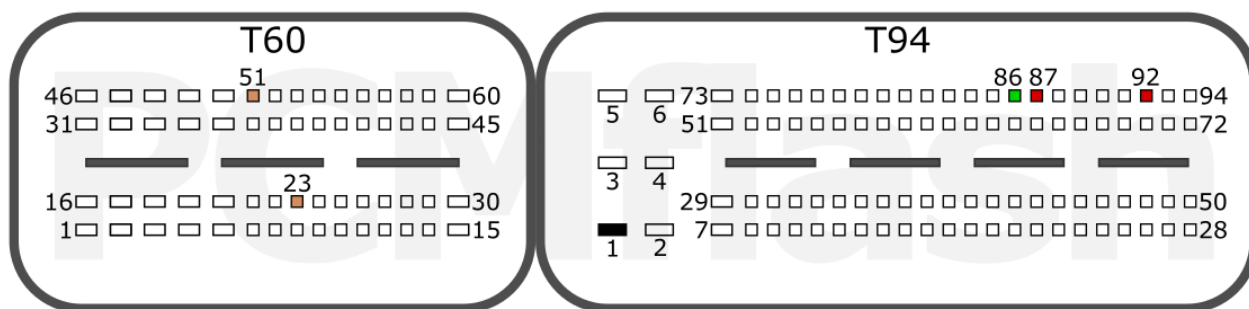

+12V	T94: 87, 92	GPT	T60: 51, 23
GND	T94: 1	K-LINE	T94: 86

VAG

pcmflash.ru

v.1

2021-07-31

PCMflash

Engine Control Unit

ME9.6

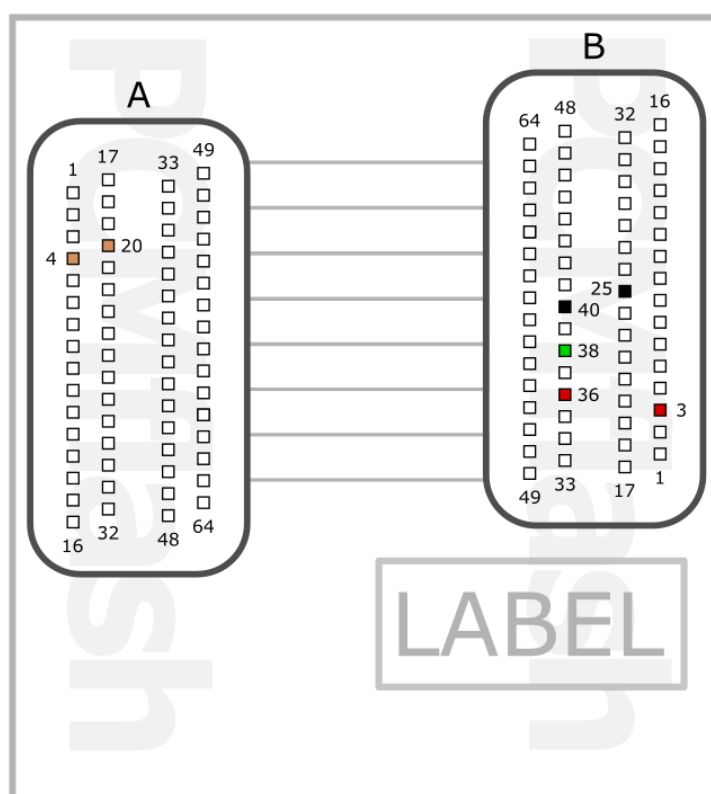

+12V	B: 3, 36	GPT*	A: 4, 20
GND	B: 25, 40	K-LINE*	B: 38
* Enable "Reduced transfer rate" option in the PCMflash settings /			
* В Настройках программы необходимо включить "Уменьшить скорость обменов"			

CADILLAC

SAAB

pcmflash.ru

v.1

2022-07-09

PCMflash

Engine Control Unit

ME9.6.2

T1

T2

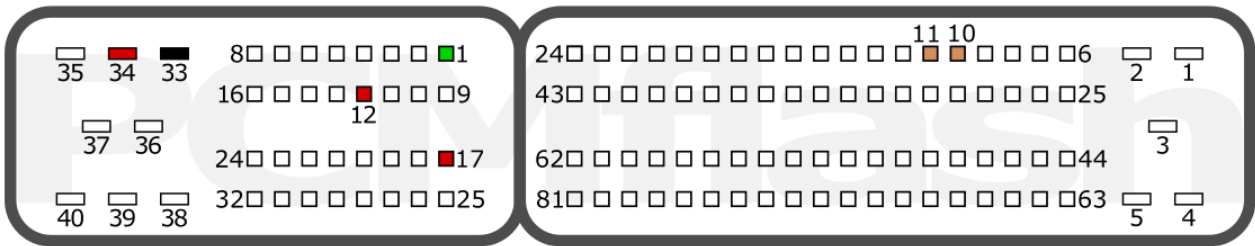

+12V	T1: 12, 17, 34	GPT	T2: 10, 11
GND	T1: 33	K-LINE	T1: 1

SUZUKI

pcmflash.ru

v.1

2024-01-08

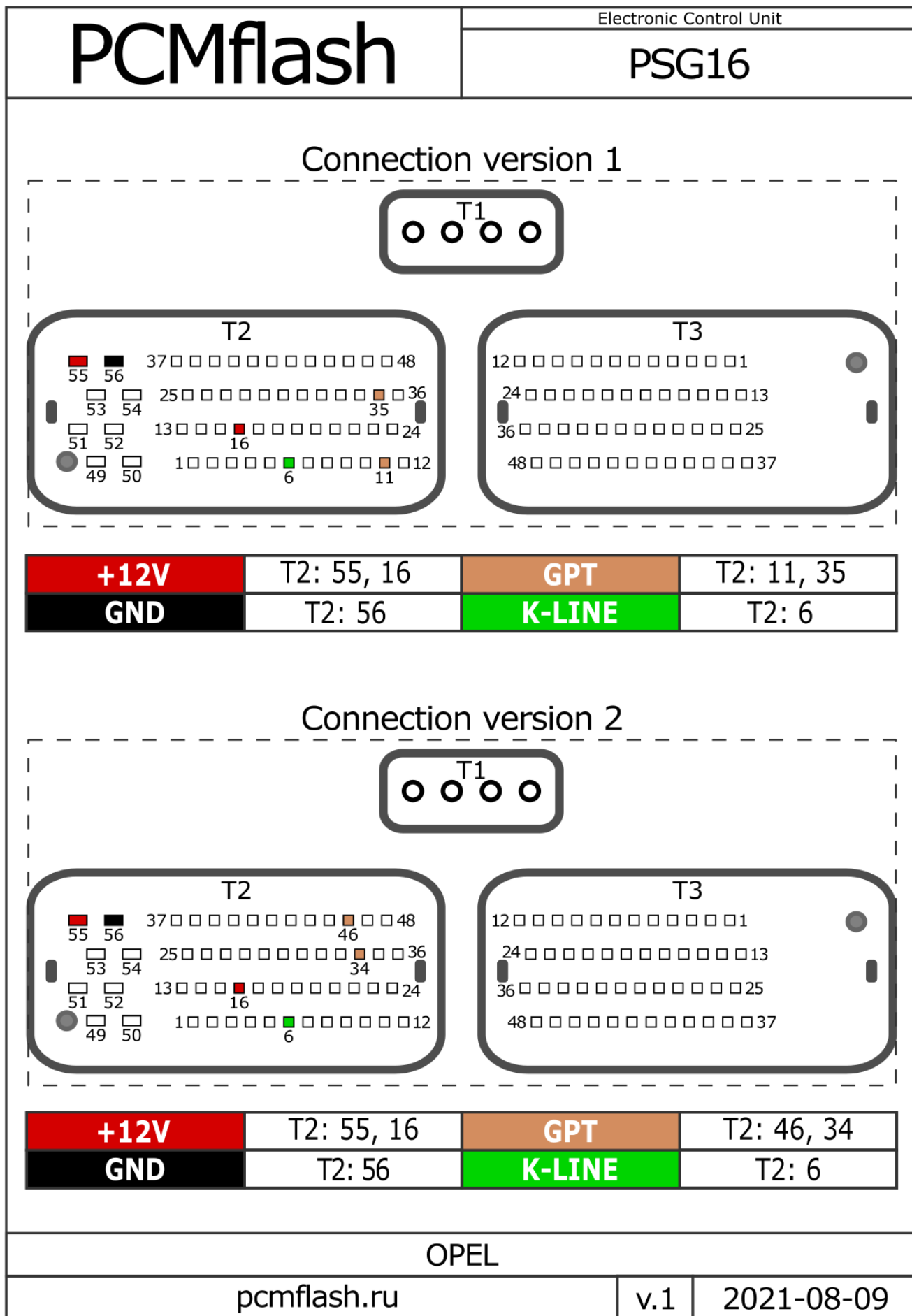

PCMflash

Electronic Control Unit

PSG16

Connection version 3

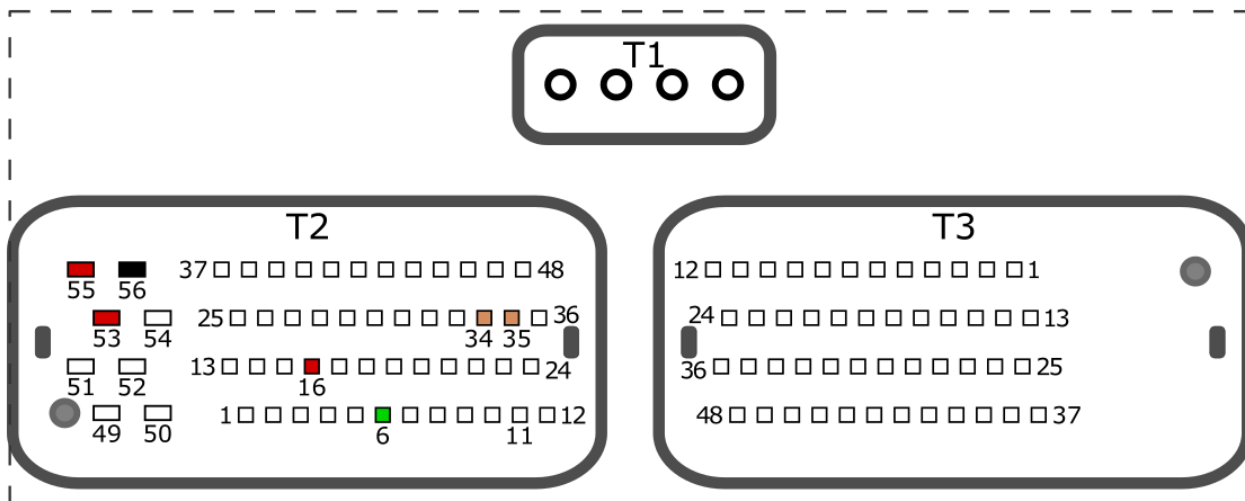

+12V	T2: 55, 53, 16	GPT	T2: 34, 35
GND	T2: 56	K-LINE	T2: 6

OPEL

pcmflash.ru

v.1

2023-09-10

PCMflash

Transmission Control Unit

6HPxx Bosch TCU

Connection version 1

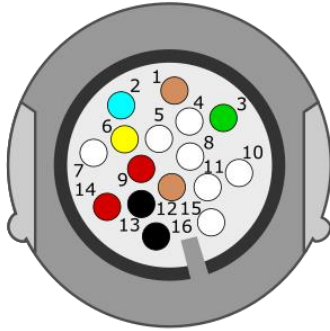

Type 1/Тип 1

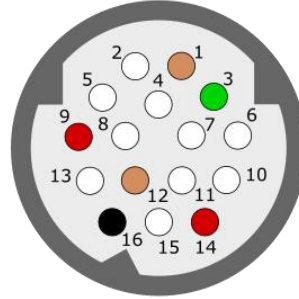

Type /Тип 2

+12V	9, 14	GPT	1, 12
GND	13, 16	K-LINE	3
CAN-L	2 (Not used)	CAN-H	6 (Not used)

Connection version 2

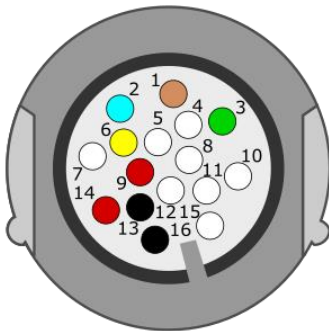

Type 1/Тип 1

GPT2
see below

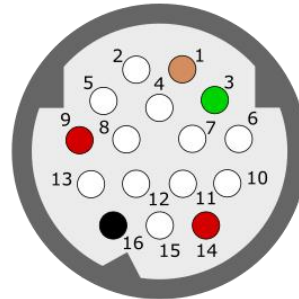

Type 2/Тип 2

Position switch/Позиционер

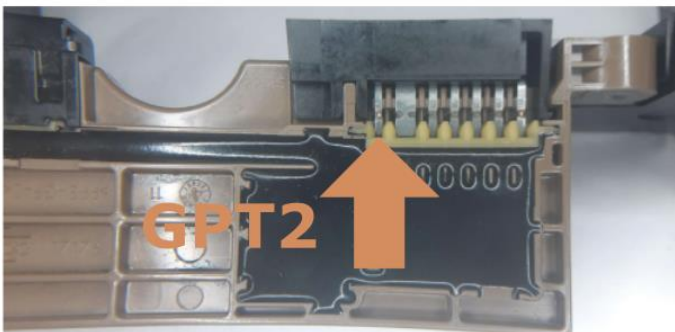

Remove cap/Снять крышку

BMW

JLR

VAG

pcmflash.ru

v.1

2021-11-24

PCMflash

Transmission Control Unit

RE5R05A TCU

Front side/Передняя сторона

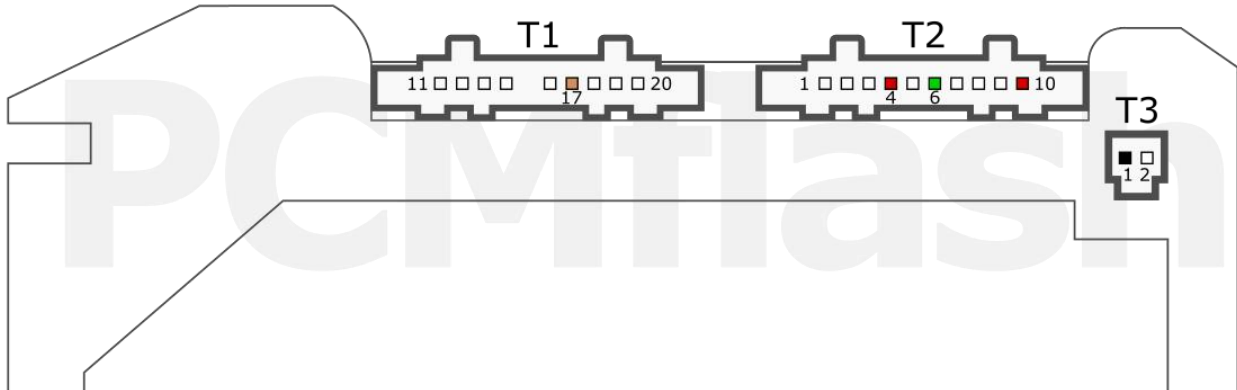

+12V	T2:4, 10	GPT	T1:17, back side
GND	T3:1	K-LINE	T2:6

Back side/Задняя сторона



See the next page/Смотри следующую страницу

NISSAN

pcmflash.ru

v.2

2021-12-06

PCMflash

Transmission Control Unit

RE5R05A TCU

With the lid open/С открытой крышкой

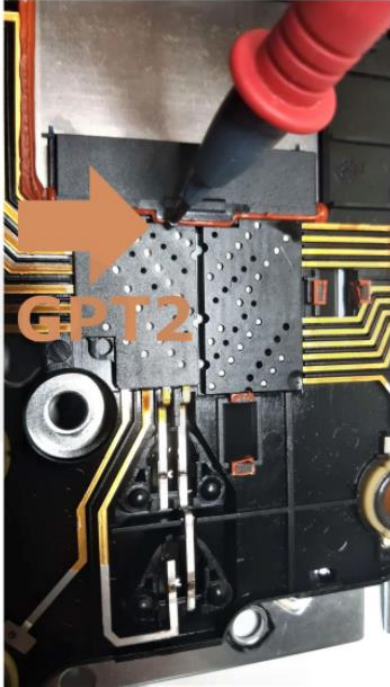

Option 1/Вариант 1

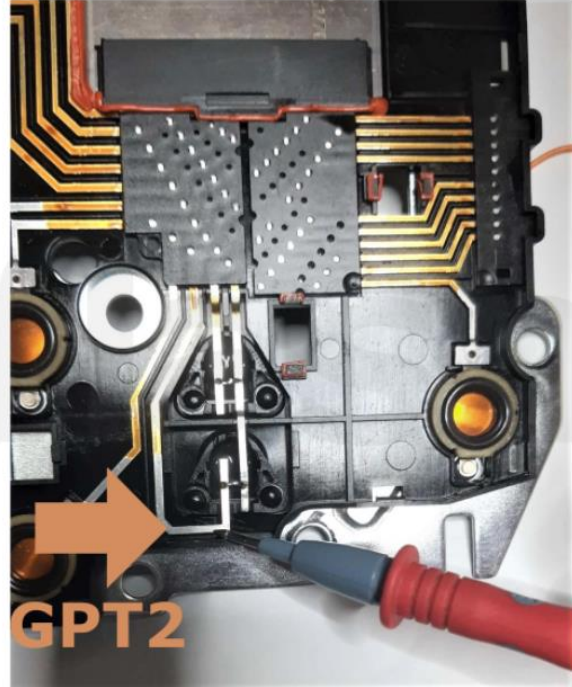

Option 2/Вариант 2

Without opening the lid/Без открытия крышки



Option 1/Вариант 1 (The best/ Лучший)

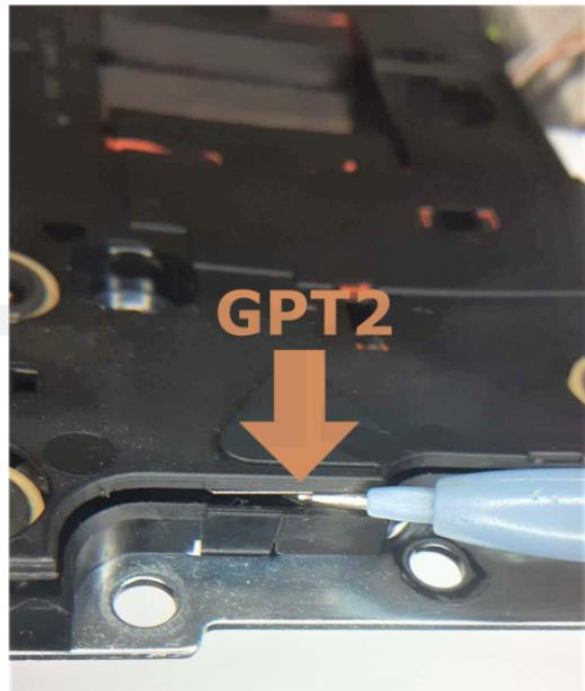

Option 2/Вариант 2

NISSAN

pcmflash.ru

v.2

2021-12-06

PCMflash

Transmission Control Unit

RE5R05A 0260550023 TCU

Front side/Передняя сторона

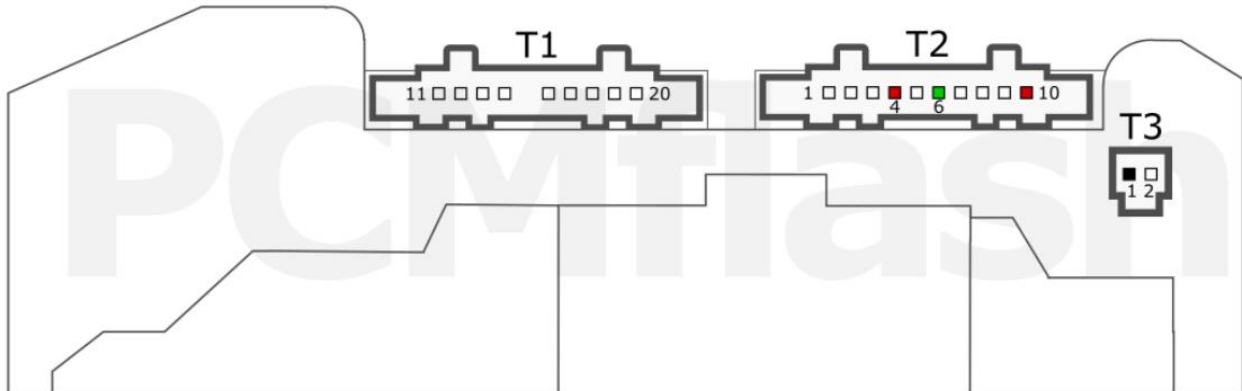

+12V	T2:4, 10	GPT	Back side
GND	T3:1	K-LINE	T2:6

Back side/Задняя сторона

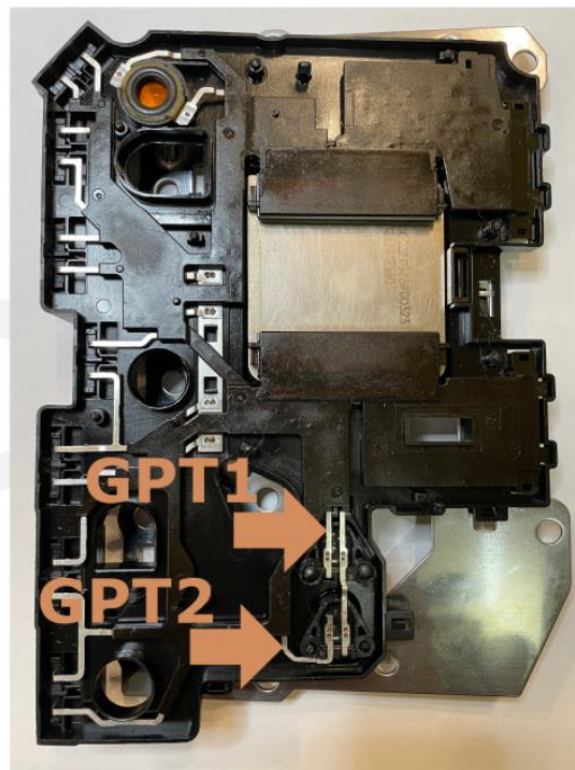

With the lid open/С открытой крышкой

NISSAN

pcmflash.ru

v.1

2021-12-08

PCMflash

Transmission Control Unit

TC14 TCU

KIA/HYUNDAI A5SR1/A5SR2/A6GF1

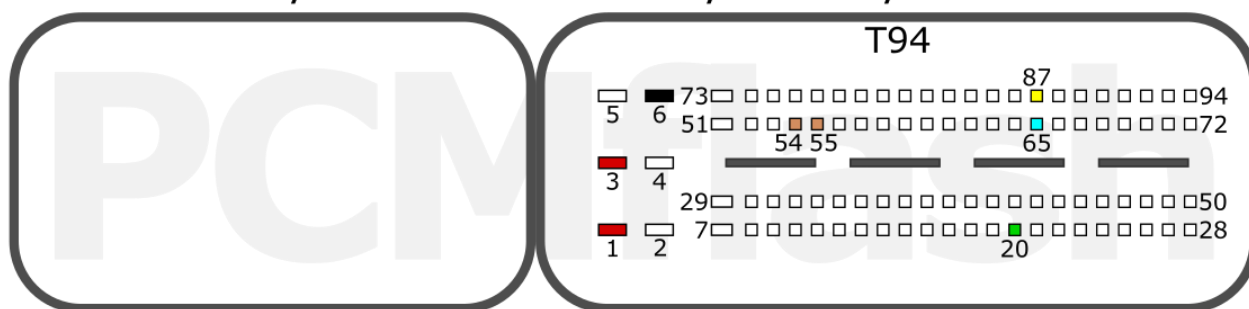

+12V	T94: 1, 3	GPT	T94: 54, 55
GND	T94: 6	K-LINE	T94: 20
CAN-L	T94: 65 (Not used)	CAN-H	T94: 87 (Not used)

KIA/HYUNDAI

pcmflash.ru

v.1

2021-11-22