

# PCMflash module 80

Denso SH725XX/1N83M

## Contents/Оглавление

Contents/Оглавление.....	2
DAIHATSU/TOYOTA SH72531 .....	3
FAW SH72530 .....	4
HINO/KIA/HYUNDAI TRUCK E6 (SH725xx/1N83M) .....	5
HINO300 EURO5/EURO6 1N83M .....	6
HINO AdBlue 1N83M.....	7
HONDA SH72544 TCU.....	8
HYUNDAI PETROL SH72530 .....	9
HYUNDAI/KUBOTA SH7254x .....	10
KOHLER DC1U 1N83M .....	11
KUBOTA SH72543.....	12
KUBOTA AdBlue SH72531 .....	13
MAZDA DIESEL SH725xx.....	14
MAZDA PETROL SH725xx.....	15
MAZDA GEN 4 1N83N .....	16
MAZDA TCM.....	17
MITSUBISHI/SUBARU SH72543 .....	18
NISSAN SH72530/SH72531 .....	19
SUBARU SH72531 .....	20
SUBARU 1.6L, 2.0L, 2.5L DI 1N83M .....	21
SUZUKI SH72530/72533.....	22
SUZUKI 1N83M .....	23
VOLVO SH7254x .....	24



# PCMflash

Engine Control Unit

## SH72530

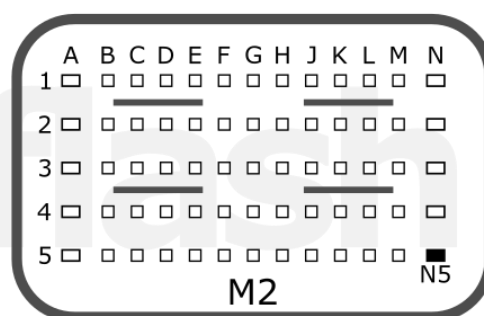
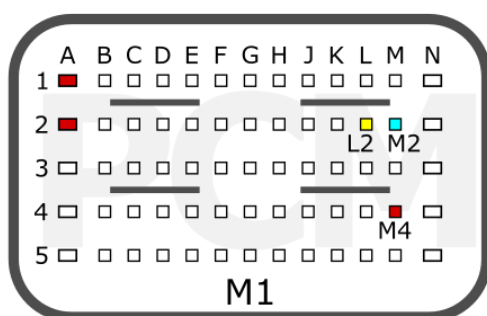

<b>+12V</b>	M1: A1, A2, M4	<b>CAN-L</b>	M1: M2
<b>GND</b>	M2: N5	<b>CAN-H</b>	M1: L2

FAW

pcmflash.ru

v.1

2021-09-13



# PCMflash

Engine Control Unit

## 1N83M

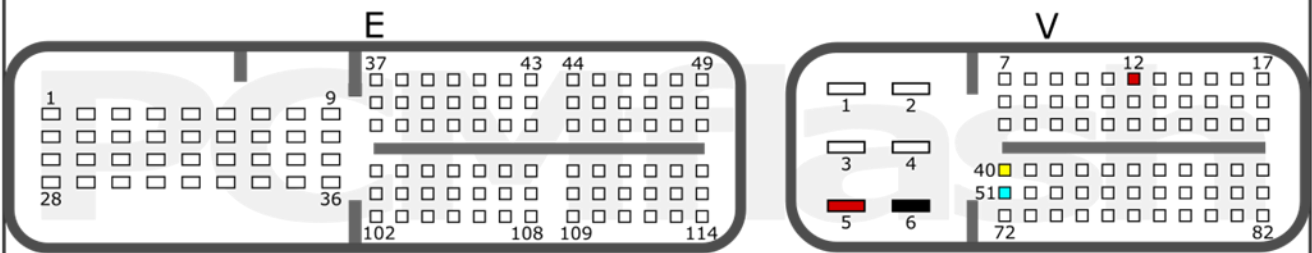

<b>+12V</b>	V: 5, 12	<b>CAN-L</b>	V: 51
<b>GND</b>	V: 6	<b>CAN-H</b>	V: 40

HINO 300 EURO 5/EURO 6

pcmflash.ru

v.1

2022-08-03

# PCMflash

AdBlue Control Unit

## 1N83M

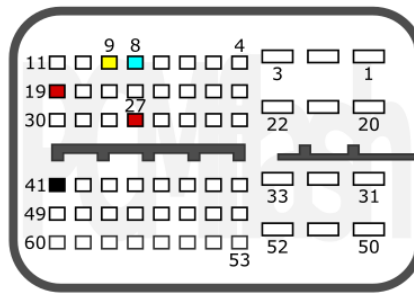

<b>+12V</b>	19, 27	<b>CAN-L</b>	8
<b>GND</b>	41	<b>CAN-H</b>	9

HINO AdBlue

pcmflash.ru

v.1

2024-03-30

# PCMflash

Transmission Control Unit

SH72544

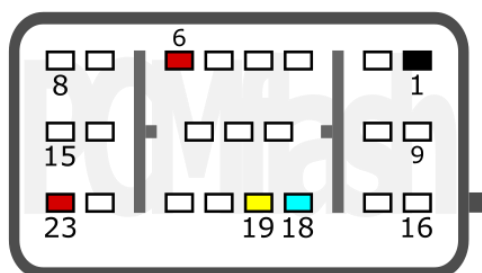

<b>+12V</b>	6, 23	<b>CAN-L</b>	18
<b>GND</b>	1	<b>CAN-H</b>	19

HONDA

pcmflash.ru

v.1

2024-06-17

# PCMflash

Engine Control Unit

## SH72530

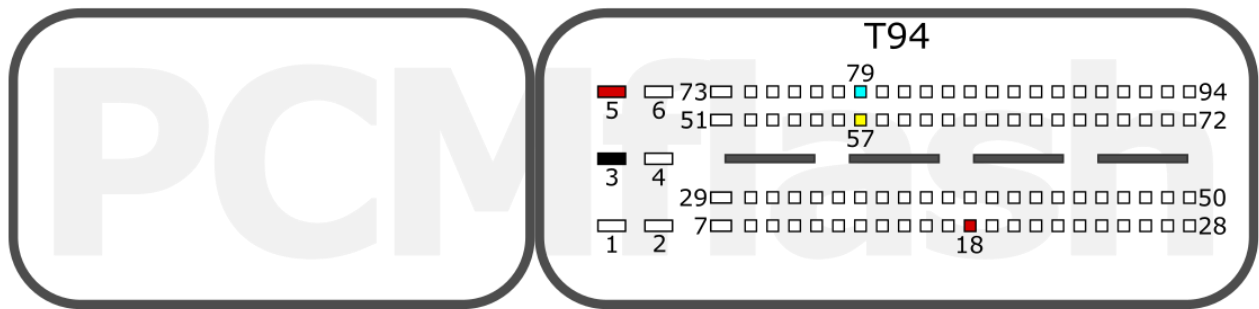

<b>+12V</b>	T94: 5, 18	<b>CAN-L</b>	T94: 79
<b>GND</b>	T94: 3	<b>CAN-H</b>	T94: 57

HYUNDAI PETROL

pcmflash.ru

v.2

2023-04-08

# PCMflash

Engine Control Unit

## DENSO SH7254x

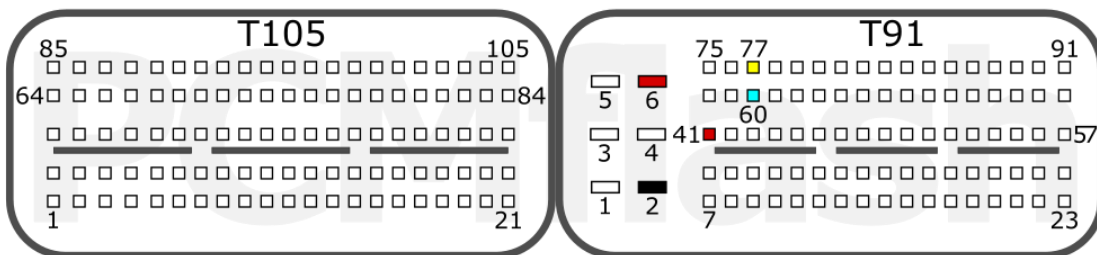

<b>+12V</b>	T91: 6, 41	<b>CAN-L</b>	T91: 60
<b>GND</b>	T91: 2	<b>CAN-H</b>	T91: 77

HYUNDAI

KUBOTA

pcmflash.ru

v.2

2022-07-16

# PCMflash

Engine Control Unit

## 1N83M

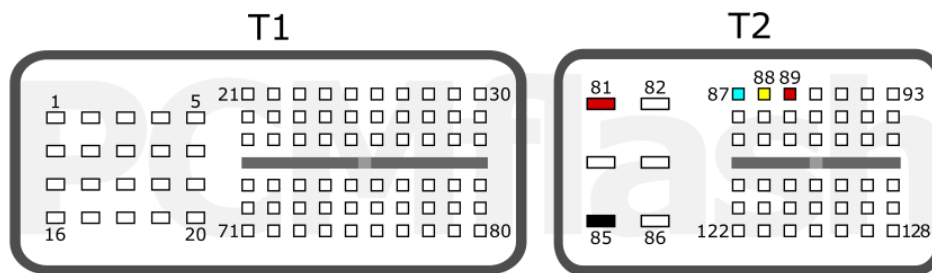

<b>+12V</b>	T2: 81, 89	<b>CAN-L</b>	T2: 87
<b>GND</b>	T2: 85	<b>CAN-H</b>	T2: 88

KOHLER

McCormick

Landini

JCB

pcmflash.ru

v.1

2024-04-10

# PCMflash

Engine Control Unit

## SH72543

LABEL

T1

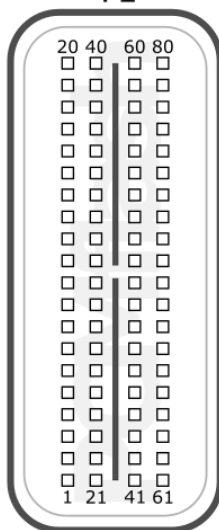

T2

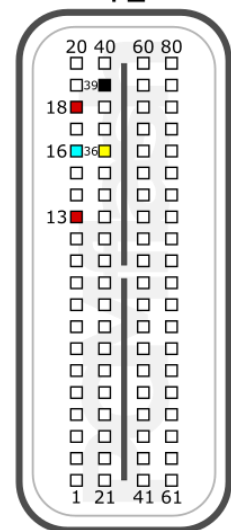

<b>+12V</b>	T2: 13, 18	<b>CAN-L</b>	T2: 16
<b>GND</b>	T2: 39	<b>CAN-H</b>	T2: 36

KUBOTA

pcmflash.ru

v.1

2024-04-18

# PCMflash

AdBlue Control Unit

## SH72531

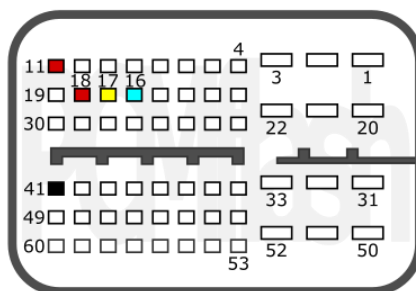

<b>+12V</b>	11, 18	<b>CAN-L</b>	16
<b>GND</b>	41	<b>CAN-H</b>	17

KUBOTA AdBlue

pcmflash.ru

v.2

2024-03-30

# PCMflash

Engine Control Unit

## SH725xx

### SKYACTIV-D (SH72543)

A

B

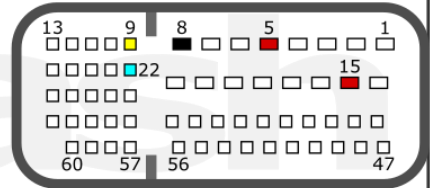
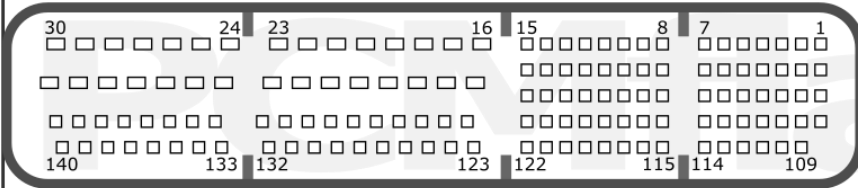

<b>+12V</b>	B: 5, 15	<b>CAN-L</b>	B: 22
<b>GND</b>	B: 8	<b>CAN-H</b>	B: 9

### SKYACTIV-D S5 (SH72546)

A

B

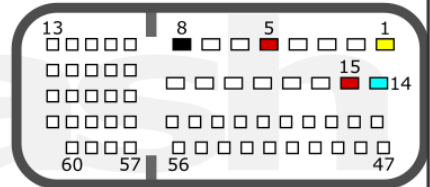
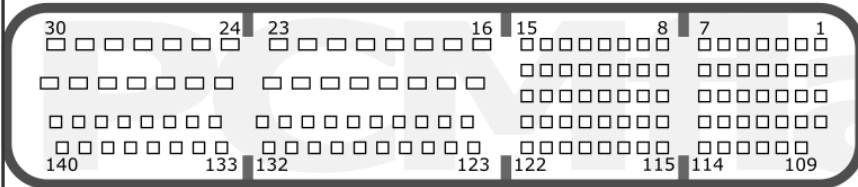

<b>+12V</b>	B: 5, 15	<b>CAN-L</b>	B: 14
<b>GND</b>	B: 8	<b>CAN-H</b>	B: 1

MAZDA DIESEL

pcmflash.ru

v.4

2022-08-03

# PCMflash

Engine Control Unit

## SH725xx

### SKYACTIV-G (SH72543)

A

B

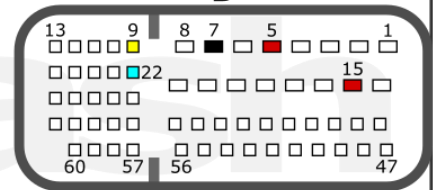
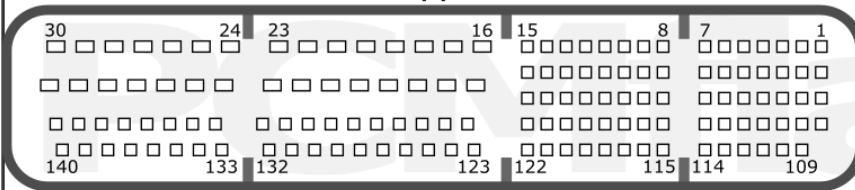

<b>+12V</b>	B: 5, 15	<b>CAN-L</b>	B: 22
<b>GND</b>	B: 7	<b>CAN-H</b>	B: 9

### SH72531

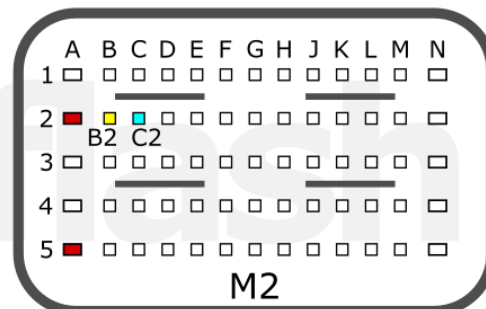
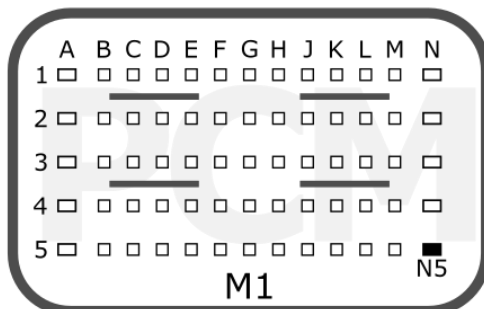

<b>+12V</b>	M2: A2, A5	<b>CAN-L</b>	M2: C2
<b>GND</b>	M1: N5	<b>CAN-H</b>	M2: B2

MAZDA PETROL

pcmflash.ru

v.3

2022-07-24

# PCMflash

Engine Control Unit

## 1N83M

### SKYACTIV-G

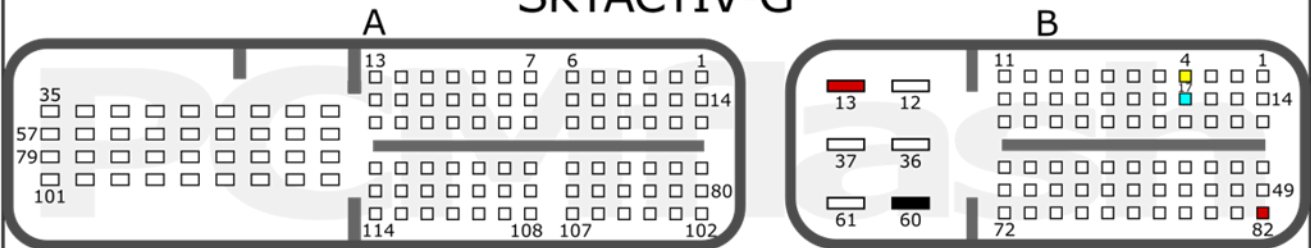

<b>+12V</b>	B: 13, 82	<b>CAN-L</b>	B: 17
<b>GND</b>	B: 60	<b>CAN-H</b>	B: 4

### SKYACTIV-D

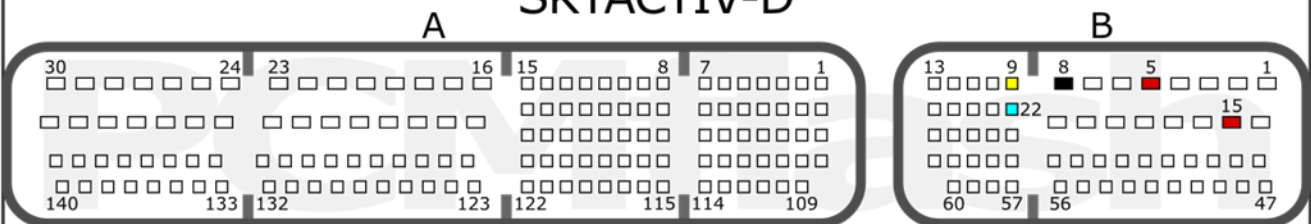

<b>+12V</b>	B: 5, 15	<b>CAN-L</b>	B: 22
<b>GND</b>	B: 8	<b>CAN-H</b>	B: 9

MAZDA GEN4

pcmflash.ru

v.1

2022-08-03

# PCMflash

Electronic Control Unit

## MAZDA TCM

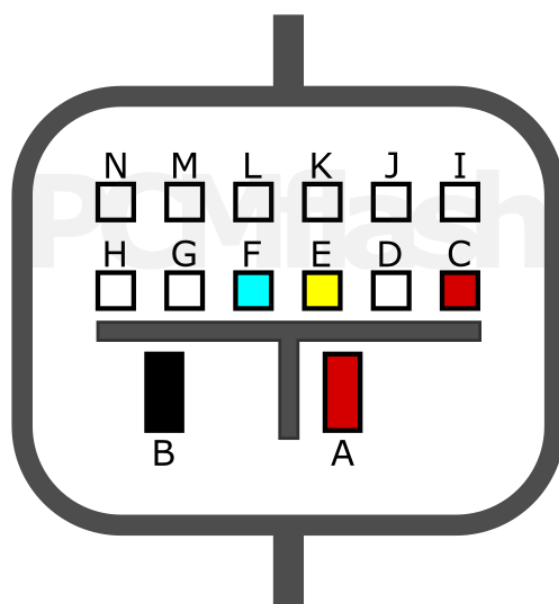

<b>+12V</b>	C, A	<b>CAN-L</b>	F
<b>GND</b>	B	<b>CAN-H</b>	E

MAZDA

# PCMflash

Engine Control Unit

## SH72543

A

B

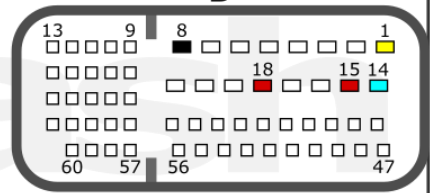
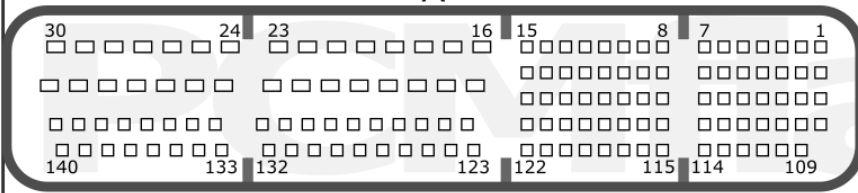

<b>+12V</b>	B: 15, 18	<b>CAN-L</b>	B: 14
<b>GND</b>	B: 8	<b>CAN-H</b>	B: 1

MITSUBISHI

SUBARU

pcmflash.ru

v.2

2022-11-02

# PCMflash

Engine Control Unit

## SH72530/SH72531

### SH72531

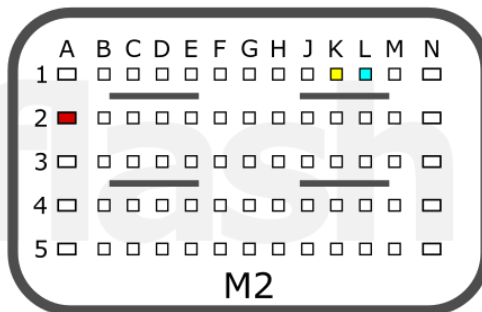
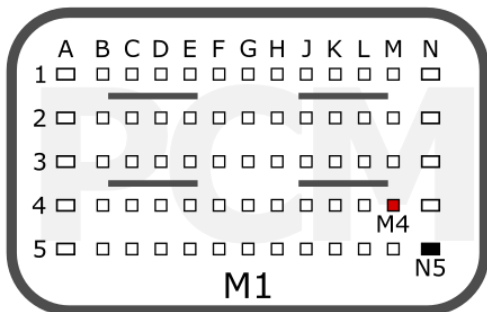

<b>+12V</b>	M1: M4, M2: A2	<b>CAN-L</b>	M2: L1
<b>GND</b>	M1: N5	<b>CAN-H</b>	M2: K1

### T1 SH72530 + SH72531 T2

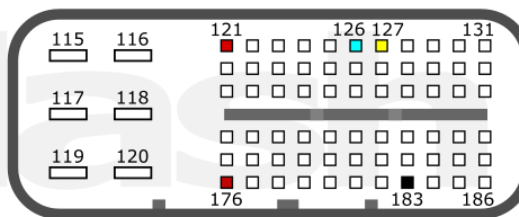
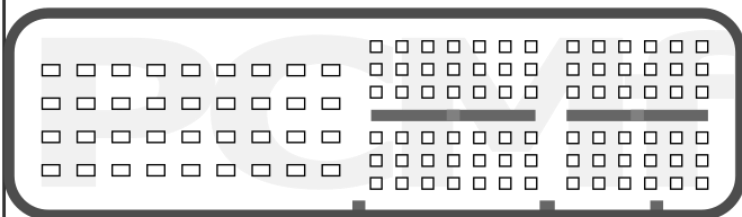

<b>+12V</b>	T2: 121, 176	<b>CAN-L</b>	T2: 126
<b>GND</b>	T2: 183	<b>CAN-H</b>	T2: 127

NISSAN

pcmflash.ru

v.3

2023-07-23

# PCMflash

Engine Control Unit

## SH72531



<b>+12V</b>	T4: 1, 27	<b>CAN-L</b>	T4: 18
<b>GND</b>	T4: 4	<b>CAN-H</b>	T4: 19

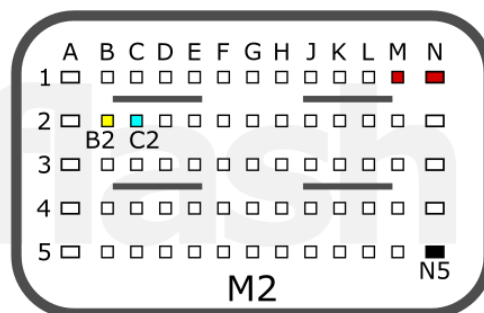
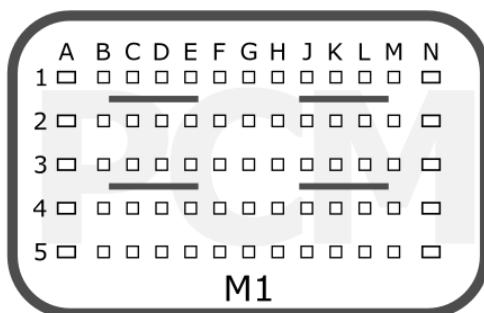

<b>+12V</b>	M2: M1, N1	<b>CAN-L</b>	M2: C2
<b>GND</b>	M2: N5	<b>CAN-H</b>	M2: B2

SUBARU

pcmflash.ru

v.1

2021-09-17

# PCMflash

Engine Control Unit

## 1N83M

### 1.6L, 2.0L

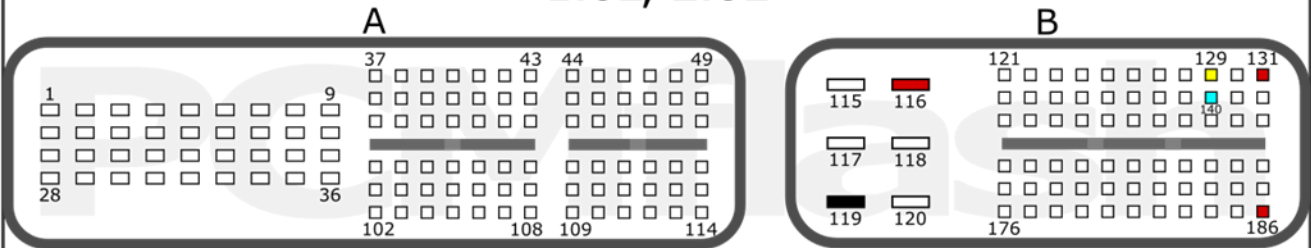

<b>+12V</b>	B: 116, 131, 186	<b>CAN-L</b>	B: 140
<b>GND</b>	B: 119	<b>CAN-H</b>	B: 129

### 2.5L

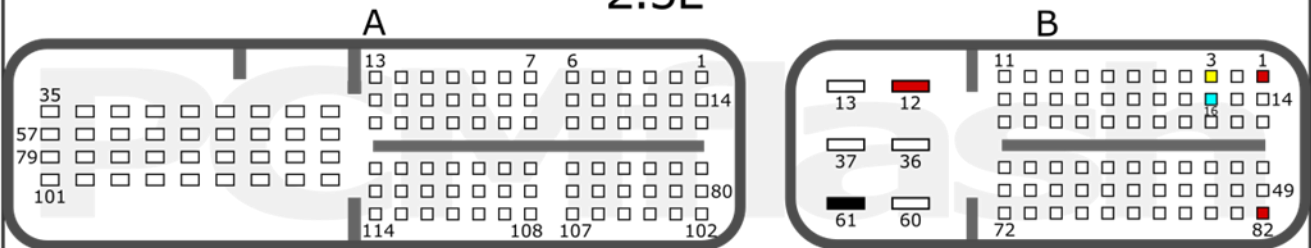

<b>+12V</b>	B: 1, 12	<b>CAN-L</b>	B: 16
<b>GND</b>	B: 61	<b>CAN-H</b>	B: 3

SUBARU 1.6L, 2.0L, 2.5L DI

pcmflash.ru

v.1

2022-08-03

# PCMflash

Engine Control Unit

## SH72530/SH72533

### SH72530/SH72533

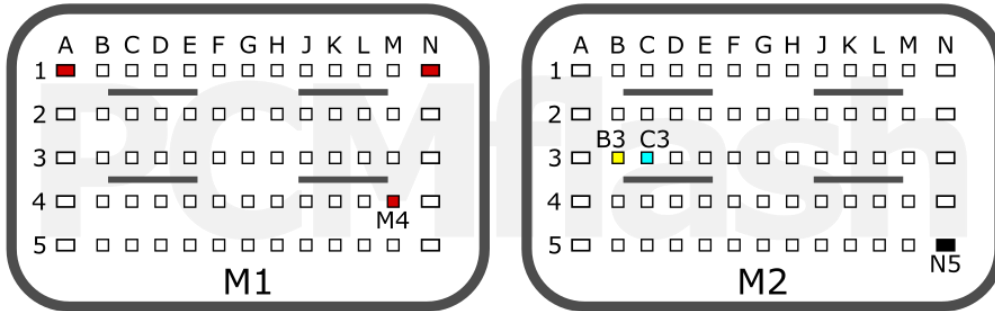

<b>+12V</b>	M1: A1, N1, M4	<b>CAN-L</b>	M2: C3
<b>GND</b>	M2: N5	<b>CAN-H</b>	M2: B3

### SH72530

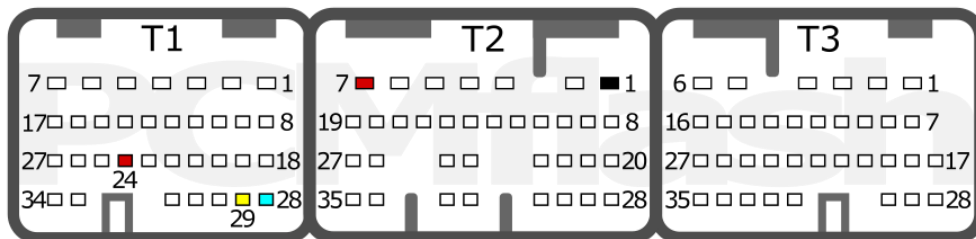

<b>+12V</b>	T1: 24; T2:7	<b>CAN-L</b>	T1: 28
<b>GND</b>	T2: 1	<b>CAN-H</b>	T1: 29

SUZUKI

pcmflash.ru

v.2

2023-01-30

# PCMflash

Engine Control Unit

## 1N83M

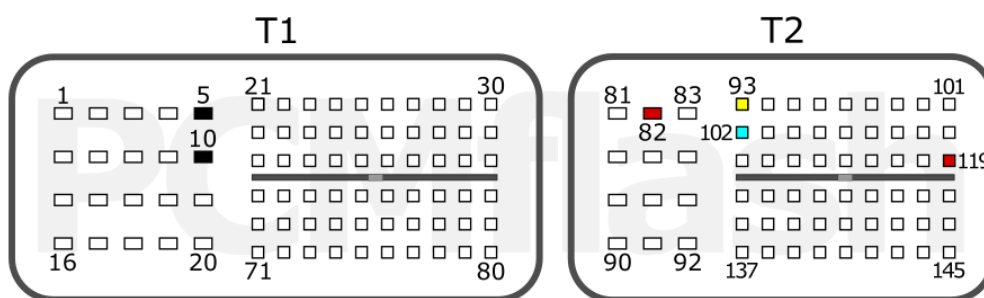

<b>+12V</b>	T2: 82, 119	<b>CAN-L</b>	T2: 102
<b>GND</b>	T1: 5, 10	<b>CAN-H</b>	T2: 93

SUZUKI

pcmflash.ru

v.1

2022-11-02

# PCMflash

Engine Control Unit

## SH7254x

### SH72543

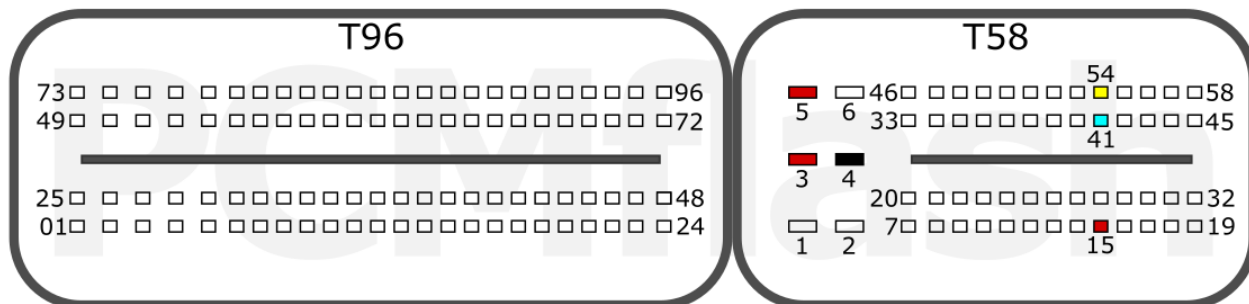

<b>+12V</b>	T58: 5, 3, 15	<b>CAN-L</b>	T58: 41
<b>GND</b>	T58: 4	<b>CAN-H</b>	T58: 54

### SH72546

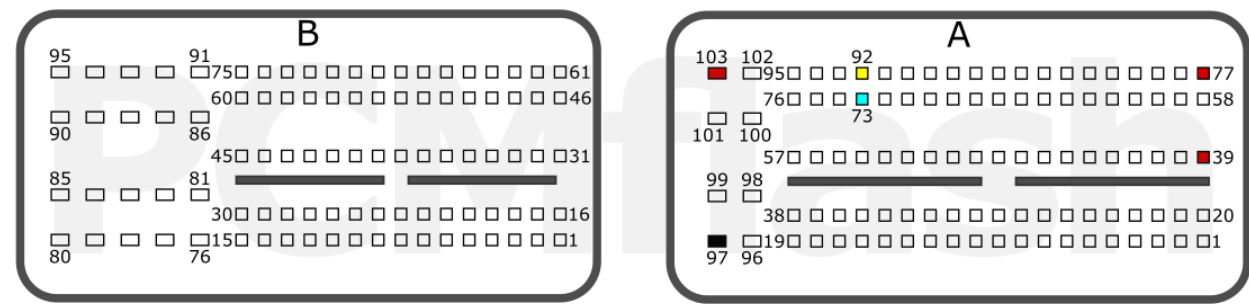

<b>+12V</b>	A: 103, 77, 39	<b>CAN-L</b>	A: 73
<b>GND</b>	A: 97	<b>CAN-H</b>	A: 92

VOLVO

pcmflash.ru

v.1

2021-08-16